

**EDH80*********EDH90*******

Enjoy peace of mind. Register your appliance today.

Stay updated on better living services,
safety notices and shop for accessories.

- 1. Open the camera app on your smartphone and point at the QR code to scan.**

Product Registration QR code is located on the front of your appliance or inside the door rim.

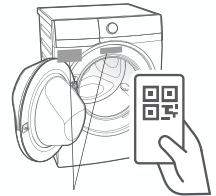

- 2. Tap the notification or link to open the registration form.**
- 3. Complete your details and enjoy peace of mind.**



Full version of the User Manual is available on www.electrolux.com. Alternatively, scan QR code, tap Electrolux logo, and search for your appliance.

Welcome to Electrolux! Thank you for choosing our appliance.





Get usage advice, brochures, troubleshooter, service information, buy accessories & spare parts, online product registration :

www.electrolux.com



CUSTOMER CARE AND SERVICE

We recommend the use of original spare parts. When contacting Service, ensure that you have the following data available. The information can be found on the rating plate. Model, PNC, Serial Number.

-  Warning / Caution-Safety information.
-  General information and tips.
-  Environmental information.

Subject to change without notice.

CONTENT

1.  SAFETY INFORMATION	3
2. SAFETY INSTRUCTIONS	7
3. PRODUCT DESCRIPTION	9
4. INSTALLATION	10
5. CONTROL PANEL	12
6. PROGRAMME TABLE	14
7. OPTIONS AND SETTINGS	16
8.  WI-FI CONNECTIVITY SETUP	19
9. DAILY USE	21
10. HINTS AND TIPS CARE	22
11. CARE AND CLEANING	23
12. TROUBLESHOOTING	26
13. TECHNICAL DATA	28
14. ENVIRONMENT CONCERNS	29

1. ⚠ SAFETY INFORMATION

Before the installation and use of the appliance, carefully read the supplied instructions. The manufacturer is not responsible if an incorrect installation and use causes injuries and damage. Always keep the instructions with the appliance for future reference.



Read the instructions.



WARNING: Flammable materials/Risk of fire.

The appliance contains flammable gas, propane (R290), a gas with a high level of environmental compatibility. Keep fire and ignition sources away from the appliance.

Be careful not to cause damage to the refrigerant circuit containing propane.

1.1 Children and vulnerable people safety

⚠ WARNING!

Risk of suffocation, injury or permanent disability.

- This appliance is not intended for use by persons (including children) with reduced physical, sensory, or mental capabilities, or lack of experience and knowledge unless they have been given supervision or instruction concerning the use of the appliance by a person responsible for their safety. Children should be supervised to ensure that they do not play with the appliance.
- Do not let children play with the appliance.

- Keep all packaging away from children and dispose of it appropriately.
- Keep detergents away from children.
- Keep children and pets away from the appliance when the door is open.
- If the appliance has a child safety device, it should be activated.
- Children shall not carry out cleaning and user maintenance of the appliance without supervision.

1.2 General Safety

- Do not change the specification of this appliance.
- The appliance can be installed as free-standing or below a kitchen counter with correct space (refer to the Installation chapter).
- Do not install the appliance behind a lockable door, a sliding door or a door with a hinge on the opposite side, that would prevent the appliance door from being fully open.
- The ventilation opening in the base must not be covered by a carpet, mat, or any floor covering.
- Connect the mains plug to the mains socket only at the end of the installation process. Make sure that the mains plug is accessible after installation.
- Ensure good air ventilation in the room where the appliance is installed to avoid the back flow of unwanted gases into the room from appliances burning gas or other fuels, including open fires.
- If the mains power supply cable is damaged, it must be replaced by the manufacturer, its Authorized Service Centre or similarly qualified persons to avoid an electrical hazard.

- Do not exceed the maximum load (refer to the "Programme chart" chapter in User manual).
- Do not use the appliance if items have been soiled with industrial chemicals.
- Wipe away lint or packaging debris that has accumulated around the appliance.
- Do not run the appliance without a filter. Clean the lint filter before or after each use.
- Do not dry unwashed items in the tumble dryer.
- Items that have been soiled with substances such as cooking oil, acetone, alcohol, petrol, kerosene, spot removers, turpentine, waxes and wax removers should be washed in hot water with an extra amount of detergent before being dried in the tumble dryer.
- Items containing foam rubber (also known as latex foam), similarly textured rubber, or materials e.g. shower caps, waterproof textiles, rubber-backed articles, and clothes or pillows fitted with foam rubber pads should not be dried in the machine on a heat setting. Foam rubber materials can produce fire by spontaneous combustion when heated.
- Fabric softeners, or similar products, should only be used as specified by the product manufacturer's instructions.
- Oil-affected items can ignite spontaneously, especially when exposed to heat sources such as in a tumble dryer. The items become warm, causing an oxidation reaction in the oil. Oxidation creates heat. If the heat cannot escape, the items can become hot enough to catch fire. Piling, stacking or storing oil-affected items can prevent heat from escaping and create a fire hazard.

- If it is unavoidable that fabrics that contain vegetable or cooking oil or have been contaminated by hair care products be placed in a tumble dryer they should first be washed in hot water with extra detergent. This will reduce, but not eliminate, the hazard.
- Remove all objects from items that could be a source of fire ignition such as lighters or matches.
- Before any maintenance operation, deactivate the appliance and disconnect the mains plug from the socket.
- Pre-treatment sprays and stain remover can damage plastic components on your machine. If you use pre-treatment sprays or stain removers, apply them to the clothing well away from your machine.

⚠ WARNING!

- The appliance must not be supplied through an external switching device, such as a timer, or connected to a circuit that is regularly switched on and off by a utility.
- Do not damage the refrigerant circuit.
- Never stop a tumble dryer before the end of the drying cycle unless all items are quickly removed and spread out so that the heat is dissipated.

1.3 CONDITIONS OF USE

The appliance is intended to be used in household and similar applications such as:

- farm houses;
- by clients in hotels, motels, bed & breakfast and other residential type environments;
- areas for communal use in blocks of flats or in laundrettes.

2. SAFETY INSTRUCTIONS

2.1 Installation

- Remove all the packaging.
- Do not install or use a damaged appliance.
- Follow the installation instructions supplied with the appliance.
- Always take care when moving the appliance as it is heavy. Always use safety gloves and enclosed footwear.
- Do not install or use the appliance where the temperature can be lower than 5°C or higher than 35°C.
- The floor area on which the appliance is to be installed must be flat, stable, heat resistant and clean.
- Make sure that there is air circulation between the appliance and the floor.
- Always keep the appliance vertical when it is being moved.
- The rear surface of the appliance must be put against a wall.
- When the appliance is in its permanent position, check if it is levelled correctly with the aid of a spirit level. If it is not, adjust the feet accordingly.

WARNING!

- Do not install the appliance in an environment with no air exchange.
- In the appliance enclosure or in the built-in structure, keep ventilation opening clear of obstruction.

2.2 Electrical connection

WARNING!

Risk of fire and electric shock.

- Connect the mains plug to the mains socket only at the end of the installation. Make sure that there is access to the mains plug after the installation.
- The appliance must be earthed.

- Make sure that the parameters on the rating plate are compatible with the electrical ratings of the mains power supply.
- Always use a correctly installed shockproof socket.
- Do not use multi-plug adapters and extension cables.
- Do not pull the mains cable to disconnect the appliance. Always pull the mains plug.
- Do not touch the mains cable or the mains plug with wet hands.

2.3 Use

WARNING!

Risk of injury electric shock, fire, burns or damage to the appliance.

- This appliance is for household (indoors) use only.
- Do not dry damaged (torn, frayed) items that contain padding or fillings.
- If laundry has been washed with a stain remover, carry out an additional rinse cycle before starting a drying cycle.
- Dry only fabrics that are suitable to dry in the appliance. Follow the cleaning instruction on the item label.
- Do not drink or prepare food with the condensed water/distilled water. It can cause health problems to people and pets.
- Do not sit or step on the open door of the appliance.
- Do not dry dripping wet clothes in the appliance.
- Fill steam generators only with liquids specified by the manufacturer. (Available for model EDH***R9**)

2.4 Internal lighting (Available for model EDH***R7**, EDH***R9**)

WARNING!

Risk of injury.

- Visible LED radiation, do not look directly into the beam.
- The LED lamp is dedicated to drum lighting. This lamp cannot be reused for other lighting purposes.
- To replace the internal lighting, contact the Authorized Service Centre.

2.5 Compressor

WARNING!

Risk of damage to the appliance.

- The compressor and its system in the tumble dryer is filled with a special agent which is free from fluoro-chloro-hydrocarbons. This system must stay tight. Damage of the system can cause a leakage.

2.6 Disposal

WARNING!

Risk of injury or suffocation.

- Disconnect the appliance from the mains electrical and water supplies.
- Cut off the mains electrical cable close to the appliance and dispose of it.
- The appliance contains flammable gas (R290). Contact your municipal authority for information on how to discard the appliance correctly. Remove the door latch to prevent accidental access by children or pets and getting trapped inside the drum.
- Dispose of the appliance in accordance with local requirements for the disposal of Waste Electrical and Electronic Equipment (WEEE).

- For more detailed information about recycling this product, Please contact your local city office, your household waste disposal service, or the shop where you purchased the product.

2.7 Care and cleaning

WARNING!

Risk of injury or damage to the appliance.

- Do not use water spray and steam to clean the appliance.
- Clean the appliance with a moist soft cloth. Use only neutral detergents. Do not use abrasive products, abrasive cleaning pads, solvents or metal objects.
- Be careful when you clean the appliance to prevent damage to the cooling system.

3. PRODUCT DESCRIPTION

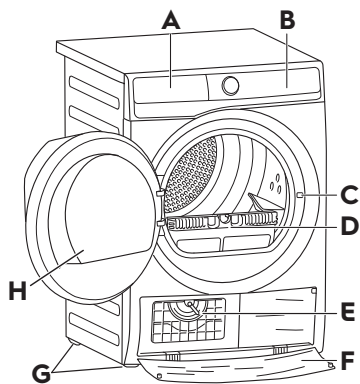

- A** Water Container
- B** Control Panel
- C** Door Lock
- D** Filter
- E** Heat Exchanger lid
- F** Heat Exchanger cover
- G** Adjustable Feet
- H** Appliance Door

4. INSTALLATION

Unpacking

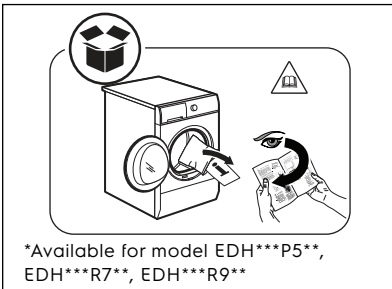
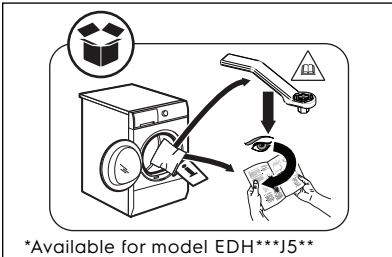
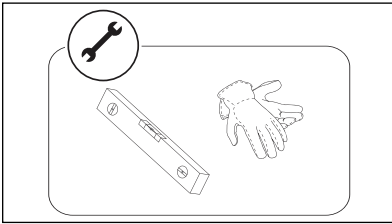

i For model **EDH***J5****, Use the **DRUM UNLOCKED KEY** to unlock Rear Drum locks, before using the appliance. For other models, the rear drum locks are removed automatically when the dryer is activated for the first time. Possible to hear some noise.

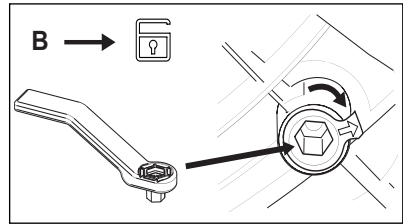
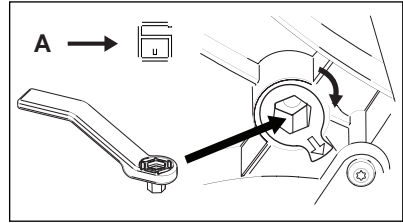
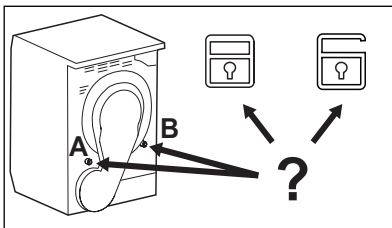

Installation

⚠ WARNING!

Before proceeding with installation, read the safety information, and dimension preferred.

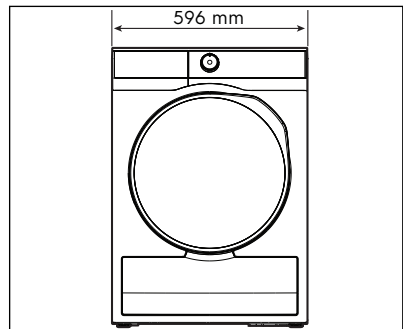

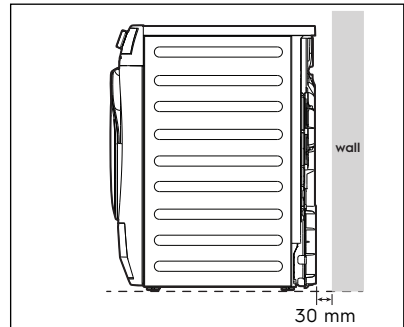
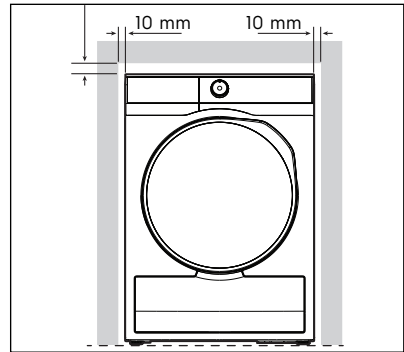
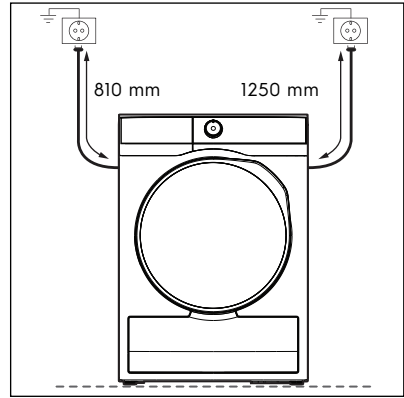
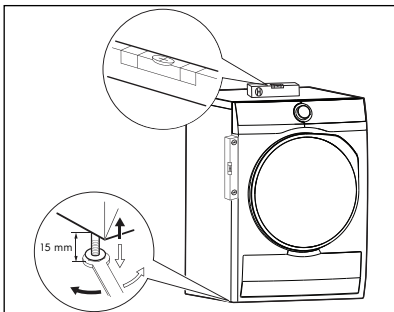
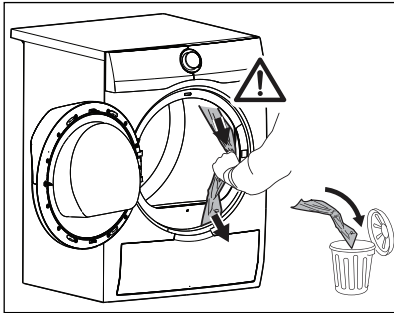
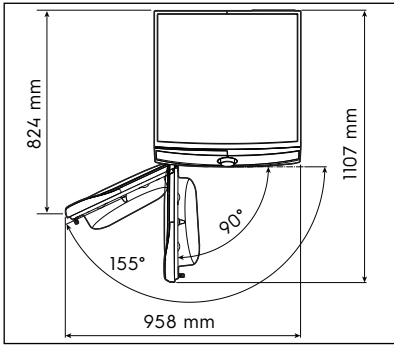
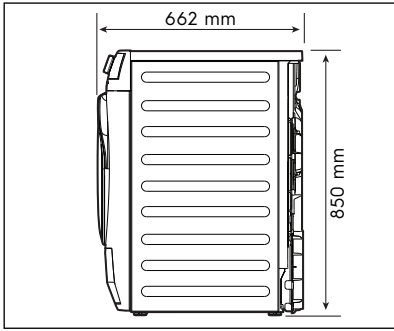



⚠ WARNING!
 The tumble dryer cannot be placed on top of a washing machine.
 For more information, please contact authorized dealer.

5. CONTROL PANEL

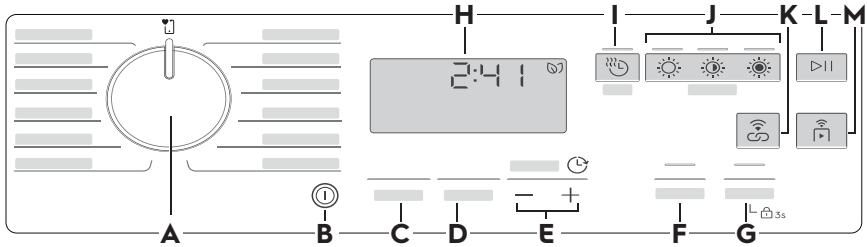
5.1 Control Panel Description



A Programme knob

B  On/Off button

C Extra Antcrease touch key

D End Alert touch key

E  Finish In Adjustment touch key

F Reverse Plus touch key

G Extra Silent
·  (Lock Option)

H Display

I  Time Dry touch key

J Dryness Level touch key

·  Iron Dry

·  Cupboard Dry

·  Extra Dry

K  SyncDry touch key

L  Start/Pause touch key

M  Remote Start touch key

 Press the touch buttons with your finger in the area with the symbol or name of the option. Do not wear gloves when you operate the control panel. Make sure that the control panel is always clean and dry.

5.2 Display

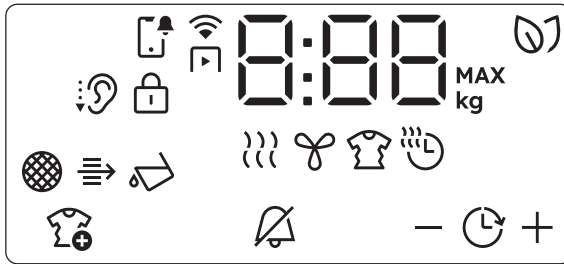

Notifications icon



Remote Start icon



SmartLeaf icon



Extra Silent icon



Child lock icon



Indicator : Clean filter



Indicator : Check heat exchanger



Indicator : Drain the water container



Indicator : Drying phase



Indicator : Cooling phase



Indicator : Anticrease phase



Time Dry icon



Extra Anticrease icon



End alert icon



Finish In icon



Decrease finish in time



Increase finish in time



Programme duration



Maximum load icon





The icon, function or phase names that appeared in this manual may differ from your product.

5.3 SmartLeaf feedback



SmartLeaf guides the consumer toward a more energy-efficient clothes drying, based on energy consumption weighted on programme's rated capacity.

There are three different level of SmartLeaf indicated by the leaf icon (green colour) :

1. No leaf lit on the display indicates an average consumption level or no indication possible (for Time based cycles).
2.  one leaf indicates a good energy consumption level.
3.  two leaves indicate the best consumption level.

6. PROGRAMME TABLE

6.1 Programme Chart

Programme	Load ¹⁾	Properties / Fabric type
Cottons	Max	White and colored cotton fabrics program. The default setting is for ready-to-store dryness level.
Eco Cottons ²⁾	Max	Cotton fabrics programme designed for maximum energy saving.
Delicates	2 kg	Recommended for generic delicate fabrics such as viscose, rayon, acrylic and their blends.
 Wool	1 kg	Gently dries machine and hand-washable woollens. Tumbling is minimized as the fast drum speed motion makes the garment lie flat on the inside of the drum walls replicating flat drying. Approved by Woolmark.
Silk	0.5 kg	Preserves the shape of delicate machine and hand-washable silk clothes, minimizing creases by using gentle warm air and soft movements.
Easy Iron	2 kg	Limits creases on small loads of cotton, synthetic and mixed-fabric garments for easy ironing. Features two drying levels: Iron leaves garments slightly damp for ironing or hanging; Cupboard fully dries items.
Refresh	1 kg	Short low temperature cycle that helps in removing odours from a small amount of garments. Indicated also for dry clothes that were in storage for long time.
Hygiene	5 kg	Dries and sanitizes your garments and other items maintaining the temperature above 60°C over time, removing 99.99% of bacteria and viruses. ³⁾ Note: This cycle should only be used for wet items. Not suitable for delicate items.
Bedding+	4.5 kg	Up to three bed linen sets, one of which can be double size.
Duvet	3 kg	Ensures proper drying of inner parts through single or double duvets, pillows, and padded blankets.
Synthetics	4 kg	Blended garments containing mostly synthetic fibres like polyester, polyamide, etc.
MixedDry	5 kg	Designed for routine drying of what you wash without sorting. Dries evenly clothes made of cotton, cotton-synthetic blends and synthetic.
		Depends on a memorized programme.

1) Maximum capacity depends on model of dryer.

2) The program "Eco cottons" (capacity, option .e.g at full load and with Cupboard Dry dryness level) is the programme for energy label tested according to AS/NZS 2442.1 and labelled according to AS/NZS 2442.2

3) Tested for Candida albicans, MS2 Bacteriophage and Escherichia coli in external test performed by Swisstest Testmaterialien AG in 2021 (Test Report No. 20212038).

Woolmark Apparel Care - Blue



The wool drying cycle of this machine has been tested and approved by The Woolmark Company. The cycle is suitable to dry wool garments which are labelled "hand wash" provided that the garments are washed in a Woolmark endorsed hand washing cycle and dried according to the instructions issued by the manufacturer. **M2140.**

6.2 Programme Options Compatibility

Programme ¹⁾	Dryness Level			Extra Anticrease	Extra Silent	Reverse Plus	Time Dry	Finish In
Cottons	■	■	■	■	■	■	■	■
Eco Cottons		■		■				■
Delicates		■		■				■
Wool							■	■
Silk		■		■				■
Easy Iron		■	■	■				■
Refresh				■				■
Hygiene	■			■				■
Bedding+	■	■	■	■			■	■
Duvet		■		■				■
Synthetics	■	■	■	■	■	■	■	■
MixedDry	■	■		■	■		■	■
	Depends on a memorized programme							

1) Together with the programme you can set 1 or more options. To activate or deactivate them, press the related touch button.

7. OPTIONS AND SETTINGS

7.1 Options

Time Dry

You can set the programme duration, from a minimum of 10 minutes to a maximum of 2 hours.

The required duration is related to the quantity of laundry in the appliance.



 We recommend that you set a short duration for small quantities of laundry or for only one item.

TIME DRYING RECOMMENDATION

10 mins.	action of cool air only (no heater).
20 - 40 mins.	additional drying to improve dryness after previous drying cycle.
>40 mins.	full drying of the small laundry loads up to 4 kg, well spun (>1200 rpm).

Dryness Level

This function helps to increase dryness of the laundry. There are 3 options:

-  Extra Dry
-  Cupboard Dry
-  Iron Dry

Start/Pause

Press the " Start/Pause" touch key to start, pause the appliance or interrupt a running programme.

Remote Start

A quick touch to activates the Remote Start function that allows you to start, pause and stop the appliance remotely.

Activating the Remote Start the machine goes in a stand-by status.

To exit this state, tap again the button and turn it off.



SyncDry

This feature lets your tumble dryer to automatically set the most appropriate programme that matches the last washing program recently executed. All you need to do is start the drying programme once your tumble dryer is loaded. No other programme settings or options are required on the tumble dryer.

Once the washing programme has come to an end, the washing machine transfers the programme data via the home router Wi-Fi to the Electrolux Cloud, as well as to your tumble dryer.

 In order to use the SyncDry function, the Electrolux tumble dryer and washing machine must be paired with our app.

To activate the function:

1. Once the wash cycle has come to an end, place the clean laundry in the tumble dryer.
2. Press the " SyncDry" touch key.
3. All display symbols will stay lighted off except Wi-Fi icon that run an animation for a few seconds as the appliance is retrieving data from the cloud.
4. Display will update itself automatically with the suggested programme. After 10 seconds, if data retrieving is unsuccessful, the button LED is switched off and the machine gives an acoustic error signal. Then previously selected programme is restored.
5. Press the " Start/Pause" touch key to begin drying process.

Extra Silent

The appliance operates with low noise without effect on the drying quality. The appliance operates slowly with longer cycle time.

Reverse Plus

Increase drum reversing frequency to reduce items twisting and entanglement. To increase uniformity of drying result and help reduce creases. Recommended for large or long items (e.g. sheets, trousers, long dresses)

Finish In

Before you start the programme, this option makes it possible to define the end of the drying programme from minimum of 1 hour to maximum of 24 hours.

End Alert

The buzzer sounds at the:

- cycle end
- start and end of the anticrease phase

The buzzer function is by default always on. You can use this function to activate or deactivate the sound.

 You can activate the "End Alert" option with all programmes.

Extra Anticrease

Extends the anticrease phase by 60 minutes at the end of the drying cycle. This function reduces creases. The laundry can be removed during the anticrease phase.

On/Off button

Press and hold briefly this button for a few seconds to activate or deactivate the appliance. A dedicated jingle sound while switching the appliance on or off, lights and display switches on.

Time Dry on Wool programme

Option suitable for Wool programme to adjust final dryness level.



7.2 Settings

Child lock function

This function prevents children playing with the appliance while a programme is operating. The touch buttons are locked. Only the "ⓘ on/off" button is unlocked.

Activating the child lock function:

1. Press the "ⓘ on/off" button to activate the appliance
2. Press and hold touch button "Extra Silent" for 3 seconds, the icon "" will flash on the display.

 To deactivate function Press and hold the same touch key few seconds, The Child lock icon "" will turn off on the display. This function remains enabled even after the appliance is switched off.



Favourite

You can do your configuration of programme and options and memorize in our app.

Adjustment of remaining laundry moisture

 Every time you enter in the "Adjustment of remaining laundry moisture" mode, previously set degree of remaining moisture will change into next value (e.g. previously set -2- will change into -1-).

To change the default degree of remaining moisture:

1. Press the "ⓘ on/off" button to activate the appliance.
2. Use the programme knob to set any programme.
3. Press and hold " Time Dry" and " Iron Dry" touch key for a few second.

One of these indicators comes on:

- -0- The maximum dryness
 - -1- The more dry laundry
 - -2- The standard dry laundry
4. Press "☀ Iron Dry" touch key again to change level "-0-", "-1-" and "-2-"

i If the display returns to the normal mode (the time of the selected programme from step 2. Will be displayed), while setting the degree of remaining moisture, press and hold "☁ Time Dry" and "☀ Iron Dry" touch key once again to enter to the "Adjustment of remaining laundry moisture" mode (previously set degree of remaining moisture will change into next value).

5. Press and hold "☁ Time Dry" and "☀ Iron Dry" touch key at the same time.

Water container indicator

By default, the water container indicator is on. It comes on when the programme is completed or when it is necessary to empty the water container.

i If a draining kit is installed (additional accessory), the appliance automatically drains the water from the water container. In this case we recommend that you deactivate the indicator of the water container.

Deactivating the water container indicator:

1. Press the "ⓘ on/off" button to activate the appliance.
2. Press and hold touch buttons "☀ Iron Dry" and "☀ Cupboard Dry" at the same time.

The display shows one of these 2 configurations:

- The display shows "FF". After 3s the display returns to normal mode.
- The display shows "F" and icon "☀" is on. After 3s the display returns to normal mode.

8. WI-FI CONNECTIVITY SETUP

i The software in this product contains components that are based on free and open source software. Electrolux gratefully acknowledges the contributions of the open software and robotics communities to the development project. To access the source code of these free and open source software components whose license conditions require publishing, and to see their full copyright information and applicable license terms, please visit: <http://electrolux.opensourcerepository.com> (folder NIUS)"

This chapter describes how to connect the smart appliance to the Wi-Fi network and to link it to a mobile devices.

By this functionality you can receive notifications, monitor and control your tumble dryer from your mobile devices.

To connect the appliance to enjoy the full range of features and services you need:

- Wireless network at home with internet connection enabled.
- Mobile device connected to wireless network.

Frequency/ Protocol	Wi-Fi: 2.4 /802.11 bgn
Max power	Wi-Fi: 2.4 GHz: <20 dBm
Encryption	WPA, WPA2, WEP



8.1 Download, installing, and configuring our app

1. Go to the App Store/Play Store, download and install our app on your smart device.



- * Minimum requirements: iPhone6/iOS 9.3/Android 5.1 and above. You will need to install our app, create an account, and accept the Terms and Conditions and Electrolux's Privacy Policy in the app to use the connected features of the laundry appliance. Internet and Wi-Fi connections are required to use the full features of the app and the laundry appliance. Minimum requirements, apps, and services are subject to change without notice.
2. create an account. You can only create one account per product. This account can be shared across multiple devices.
 3. Setting up your machine. Make sure your machine is plugged in and operating normally, stand near it with your smart device. Tap on "Appliances" at the bottom of the home screen. Tap on "Add Appliance" and follow the prompts on screen.
 4. Turning on your machine's Wi-Fi. Initially, your machine creates its own Wi-Fi network to assist in setting up. After setup this network disappears and your machine will connect to your home Wi-Fi network.

Press and hold " Remote Start" touch key for 5 seconds.

And the icon " starts flashing and wireless module begins starting up. It may takes a moment seconds before it is ready. When the wireless module is ready, the text " (Access Point) is on to inform you, that the access point will be open for about 5 minute.

* Setup will take several minutes depending on your network speed.

5. Connect your machine: **iOS** Tap the home button to exit the app. Go to "Settings" on your phone and select "Wi-Fi". Select your machine's Wi-Fi network. It is the one that begins with "IOT" (it may take a few moments to appear). Tap the home button to exit your phone settings and then return to our app.

Wait for confirmation of connection which may take up to a minute before proceeding to the next step.

i For iOS devices, you will then be prompted go to "SETTINGS" on your phone and select your Home Wi-Fi, then return to our app.

Android

devices, select your machine's Wi-Fi network from the drop-down box.

6. Connect your machine to your home Wi-Fi. You'll need to select your Wi-Fi network name and input your. If the connectivity is configured, "AP" (Access Point) symbol is off and the icon "Wi-Fi" will stop blinking and lit steadily to confirm that the configuration was successful
Connection success!

i Every time you switch the machine on, the machine takes 45 seconds to connect to the network automatically. When the "Wi-Fi" indicator stops blinking the connection is ready. Please proceed to the next screen to register the machine.

7. Product registration; Simply add your machine's name and the purchase date

Congratulations!

Now you're all set up. You can start exploring our app.

To remove the wireless credentials, Press and hold "Remote Start" touch key for 10 seconds until the second acoustic signal show "Remote Start" appears on the display.

8.2 Remote Start

When the app is installed and the wireless connection is complete, you can start and stop a programme remotely by activate remote start.

i The Remote Control activates automatically when you press the ">|| Start/Pause" button to start the programme, but it is also possible to start a programme.

Activate Remote Start

1. Press the "Remote Start" touch key and the icon "Remote Start" appears on the display. Now it is possible to start the programme remotely.

Deactivate Remote Start

1. Press the "Remote Start" touch key. The "Remote Start" icon is off

8.3 Over-the-air update

The application may propose an update for downloading new features.

The update is accepted via app only. If a programme is running, the app notifies that the update will start at the end of the programme.

During the update, the appliance shows "Updating" in the display.

The appliance will be usable again at the end of the update, without any notification about a successful update.

If an error occurs, the appliance shows "Error" in the display: just press any buttons or turn the knob to return to normal use.

9. DAILY USE

9.1 Start a programme without Finish In

Before you use the appliance to dry items:

1. Prepare the laundry and load the appliance.

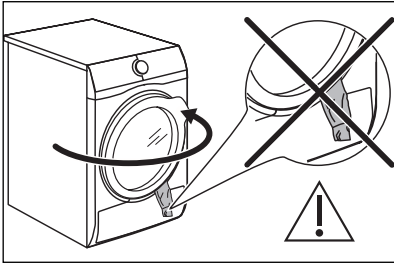

CAUTION!

Make sure that when you close the door, the laundry does not get caught between the appliance door and the rubber seal.

2. Press the "⏻ on/off" button to activate the appliance.
3. Set the correct programme and options for the type of load.

The display shows the programme duration.

 Real drying time will depend on type of the load (quantity and composition), the room temperature and the humidity of your laundry after spin drying phase.

4. Press the "▶|| Start/Pause" touch key. The programme starts.

9.2 Starting the programme with Finish In

1. Set the correct programme and options for the type of load.
2. Press the "⌚ Finish In (-) and (+)" touch key.
 - : Decrease finish in time.
 - + : Increase finish in time.

 You can delay the start of a programme "⌚ Finish In (-) and (+)" (Minimum is 1hr (depend on cycle) and maximum is 24hr.)

3. During Finish In phase on the display will show 3h, 2h or 1h. After cycle start on the display will show time to end of programme.

9.3 Change a programme

1. Press the "⏻ on/off" button to deactivate appliance
2. Press the "⏻ on/off" button to activate the appliance.
3. Set the programme.

9.4 At the end of the programme

When the programme is completed:

- An intermittent acoustic signal operates.
- The display shows "00:00".
- The icon "Wi-Fi" is on. (Wi-Fi model)
- The icon "🌀" is on.
- The icon "🌀" is on.
- The "▶|| Start/Pause" touch key is on.

The appliance continues to operate with the anticrease phase for approximately 30 minutes or more if "Extra Anticrease" option was set (see chapter Option -"Extra Anticrease").

The anticrease phase reduces creasing.

You can remove the laundry before the anticrease phase is completed. We recommend, for better results, that you remove the laundry when the phase is almost completed.

1. Press the "ⓘ on/off" button to deactivate the appliance.
2. Open the appliance door.
3. Remove the laundry.
4. Close the appliance door.

Possible causes of unsatisfactory drying results:

- Inadequate default dryness level settings. See chapter "Dryness level"
- Room temperature is too low or too high. Optimal room temperature is between 18°-25°C.

 Always clean the filter and empty the water container when a programme is completed.

9.5 Stand-by function

To reduce energy consumption, this function automatically deactivates the appliance:

- After 5 minutes if you do not start the programme.
- After 5 minutes from the end of the programme.

10. HINTS AND TIPS CARE

10.1 Preparing the laundry







Very often the clothes after washing cycle are kneaded and tangled altogether. Drying kneaded and tangled clothes is inefficient. To assure proper air flow and even drying it is recommended to shake and load one by one the clothes to the tumble dryer.

To assure proper drying process:

- Close the zips.
- Close the fasteners of duvet covers.
- Do not dry ties or ribbons loose (e.g. apron ribbons). Tie them before you start a programme.
- Remove all items from pockets.
- Turn items with the internal layer made of cotton inside out. Cotton layer must be faced outwards.

- Always set the programme suitable for the type of laundry.
- Do not put light and dark colours together.
- Use suitable programme for cottons, jersey and knitwear to reduce shrinkage.
- Do not exceed the maximum load stated in the programme chapter or shown on the display.
- Dry only the laundry that is suitable for tumble drying. Refer to the fabric label on the items.
- Do not dry large and small items together. Small items can be trapped inside the large items and remain wet.
- Shake the large clothes, fabrics before placing in the tumble dryer. It is to avoid moist places inside the fabric after the drying cycle.

Fabric label	Description
	Laundry is suitable for tumble drying.
	Laundry is suitable for tumble drying at higher temperatures.
	Laundry is suitable for tumble drying at low temperatures only.
	Laundry is not suitable for tumble drying.

11. CARE AND CLEANING

11.1 Cleaning the filter

⚠ WARNING!

Avoid the use of water to clean the filter. Instead throw away lint in the dustbin (avoid dispersion of plastic fibre in ambient water).

i To achieve the best drying performances, clean the filter regularly. Clogged filters lead to longer cycles and increase in energy consumption. Use your hand to clean the filter, and if necessary a vacuum cleaner.

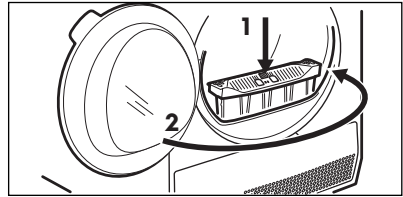
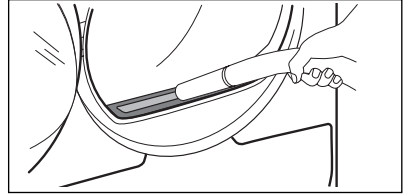
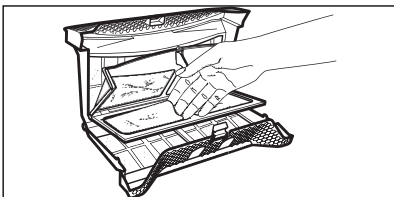
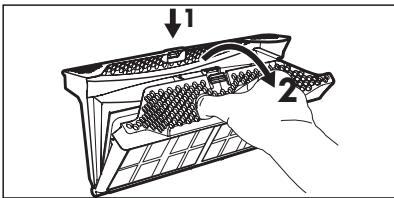
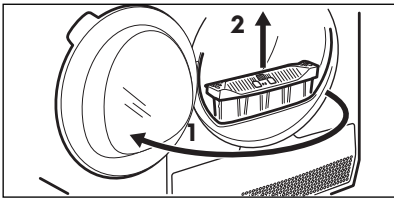
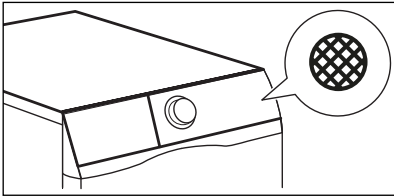

If necessary remove fluff from the filter socket and gasket. You can use a vacuum cleaner.

11.2 Emptying the water container

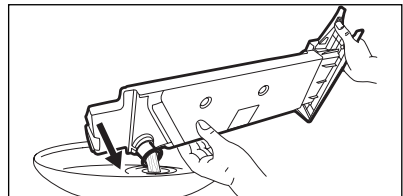
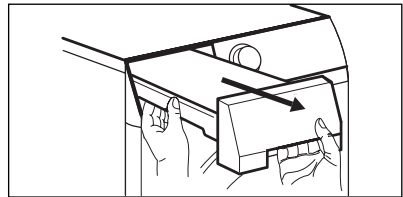
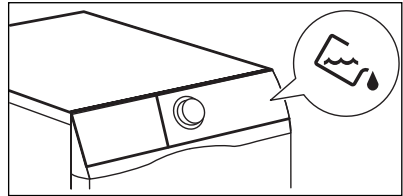

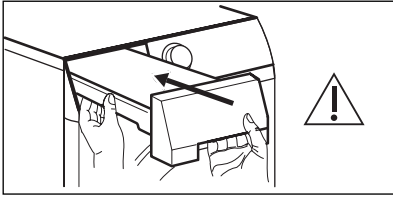

i You can use the water from the water container as an alternative to distilled water (e.g. for steam ironing). Before you use the water, remove dirt residues with a filter.

11.3 Cleaning the Heat Exchange

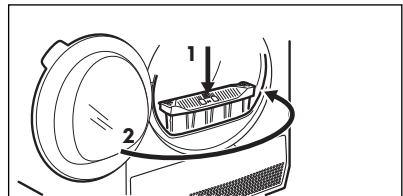
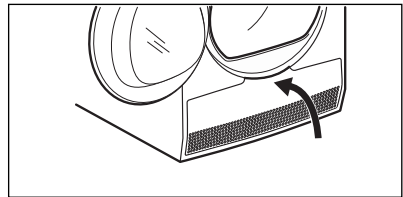
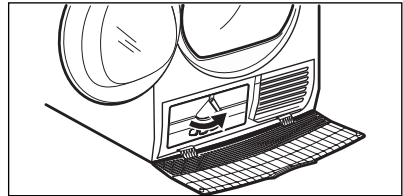
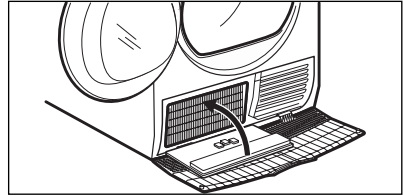
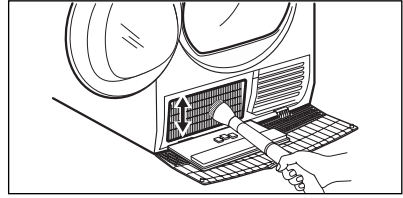
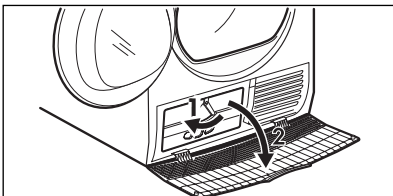
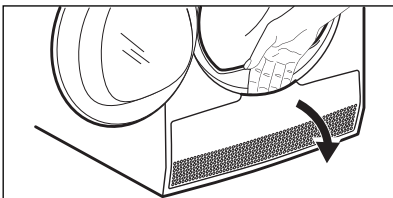
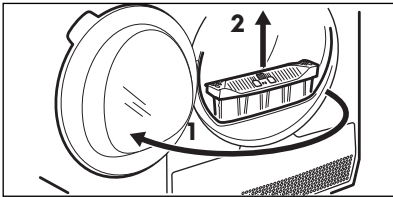
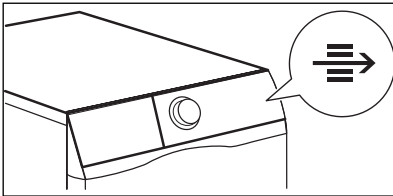

⚠ CAUTION!
Do not touch the metal surface with bare hands. Risk of injury. Wear protective gloves. Clean carefully to avoid damaging the metal surface.

11.4 Cleaning the drum

WARNING!

Disconnect the appliance before you clean it.

Use a standard neutral soap detergent to clean the inner surface of the drum and drum lifters. Dry the cleaned surfaces with a soft cloth.

CAUTION!

Do not use abrasive materials or steel wool to clean the drum.

11.5 Cleaning the control panel and housing

Use a standard neutral soap detergent to clean the control panel and housing.

Use a moist cloth to clean. Dry the cleaned surfaces with a soft cloth.

CAUTION!

Do not use furniture cleaning agents or cleaning agents which can cause corrosion.

11.6 Cleaning the airflow slots

Use a vacuum cleaner to remove fluff from the airflow slots.

12. TROUBLESHOOTING

WARNING!

Deactivate the appliance before you do the checks.

Malfunction	Alarm Code	Possible cause	Solution
<ul style="list-style-type: none"> The programme was not complete 	E50	<ul style="list-style-type: none"> Appliance motor overloaded. Too much laundry or entrap in the drum. 	<ul style="list-style-type: none"> The programme was not completed. Remove the laundry from the drum, set the programme and restart the cycle.
<ul style="list-style-type: none"> Machine does not start 	E40	<ul style="list-style-type: none"> The mains supply is unstable. 	<ul style="list-style-type: none"> Wait until main supply is stable then press start. If the appliance pause the cycle without any indication then press the cycle start. If the warning will occur check the power cord /socket integrity or main supply.
<ul style="list-style-type: none"> Machine does not start the steam programmes. 	E00	<ul style="list-style-type: none"> Possible empty steam tank, steam heater failure. 	<ul style="list-style-type: none"> Fill water container for steam system, Switch the appliance off and on again. If the error code appears again, contact the Authorised Service Centre.
<ul style="list-style-type: none"> Machine does not start *Connected models 	E91	<ul style="list-style-type: none"> Internal fail. No communication between electronic elements of the appliance. 	<ul style="list-style-type: none"> The programme was not finished properly or the appliance stopped too early. Switch the appliance off and on again. If the error code appears again, contact the Authorised Service Centre.

Problem	Possible solution
You cannot activate the appliance.	<p>Make sure that the mains plug is connected to the mains socket.</p> <p>Check fuse in fuse box (domestic installation).</p>
The drum does not rotate.	<p>Release the rear drum locks manually (see chapter "INSTALLATION").</p>
The programme does not start.	<p>Press "▷ Start/Pause".</p> <p>Make sure that the appliance door is closed.</p>
The appliance door does not close.	<p>Make sure that the installation of the filter is correct.</p> <p>Make sure that the laundry is not caught between the appliance door and the rubber seal.</p>
The appliance stops during operation.	<p>Make sure that the water container is empty. Press "▷ Start/Pause" to start the programme again.</p> <p>Load is too small, increase the load or use the  "Time Dry" programme.</p>

Problem	Possible solution
The cycle time is too long or unsatisfactory drying result. ¹⁾	Make sure that the weight of the laundry is suitable for the duration of the programme.
	Make sure that the filter is clean.
	The laundry is too wet. Spin the laundry in the washing machine again.
	Ensure that the room temperature is higher than +5°C and lower than +35°C. Optimal room temperature is 18°C to 25°C.
	Set the "☁ Time Dry" or the "☀ Extra Dry" programme. ²⁾
The display shows — — —	If you want to set a new programme, deactivate and activate the appliance.
	Make sure that the options are suitable for the programme.

1) After maximum 5 hours, the programme ends automatically.

2) It can happen that some area remains humid when drying big items (e.g. bed sheets).

If the drying results are not satisfactory



- The set programme was incorrect.
- The filter is clogged.
- The Heat Exchanger is clogged.
- There was too much laundry in the appliance.
- The drum is dirty.
- Incorrect setting of the conductivity sensor (See chapter "Adjustment of remaining laundry moisture" for better setting).
- The airflow slots are clogged.
- Room temperature is too low or too high (optimal room temperature 18°C to 25°C)

13. TECHNICAL DATA

Model Name	EDH803R7WC
Height x Width x Depth	850 x 596 x 662 mm
Max. depth with the appliance door open	1107 mm
Max. width with the appliance door open	958 mm
Adjustable height	850 mm (+ 15 mm - feet adjustment)
Drum volume	113 l
Maximum load	8 kg
Voltage	220-240 V
Frequency	50 Hz
Total power	700 W
Type of use	Household
Permitted ambient temperature	+ 5°C to + 35°C
Level of protection against ingress of solid particles and moisture ensured by the protective cover, except where the low voltage equipment has no protection against moisture	IPX4
Gas designation	R290
Gas weight	0.149 kg
Model Name	EDH903R7WC, EDH903R7SC
Height x Width x Depth	850 x 596 x 662 mm
Max. depth with the appliance door open	1107 mm
Max. width with the appliance door open	958 mm
Adjustable height	850 mm (+ 15 mm - feet adjustment)
Drum volume	113 l
Maximum load	9 kg
Voltage	220-240 V
Frequency	50 Hz
Total power	700 W
Type of use	Household
Permitted ambient temperature	+ 5°C to + 35°C
Level of protection against ingress of solid particles and moisture ensured by the protective cover, except where the low voltage equipment has no protection against moisture	IPX4
Gas designation	R290
Gas weight	0.149 kg

14. ENVIRONMENT CONCERNS

14.1 Packaging Materials

 The materials marked with the symbol  are recyclable.

>PE<=polyethylene

>PS<=polystyrene

>PP<=polypropylene.

This means that they can be recycled by disposing them properly in appropriate collection containers.

14.2 Old Machine

Use authorized disposal sites for your old appliance. Help to keep your country tidy!

The symbol  on the product or on its packaging indicates that this product may not be treated as household waste.

Instead it shall be handed over to the applicable collection point for the recycling of electrical and electronic equipment. By ensuring this product is disposed of correctly, you will help prevent potential negative consequences for the environment and human health, which could otherwise be caused by inappropriate waste handling of this product.

For more detailed information about recycling of this product, please contact your local city office, your household waste disposal service or the shop where you purchased the product.

electrolux.com

G0043776-001-A28646606