

EHC644BB, EHC944BB

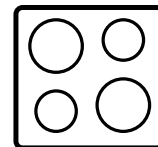

Ceramic Glass Hob

User manual

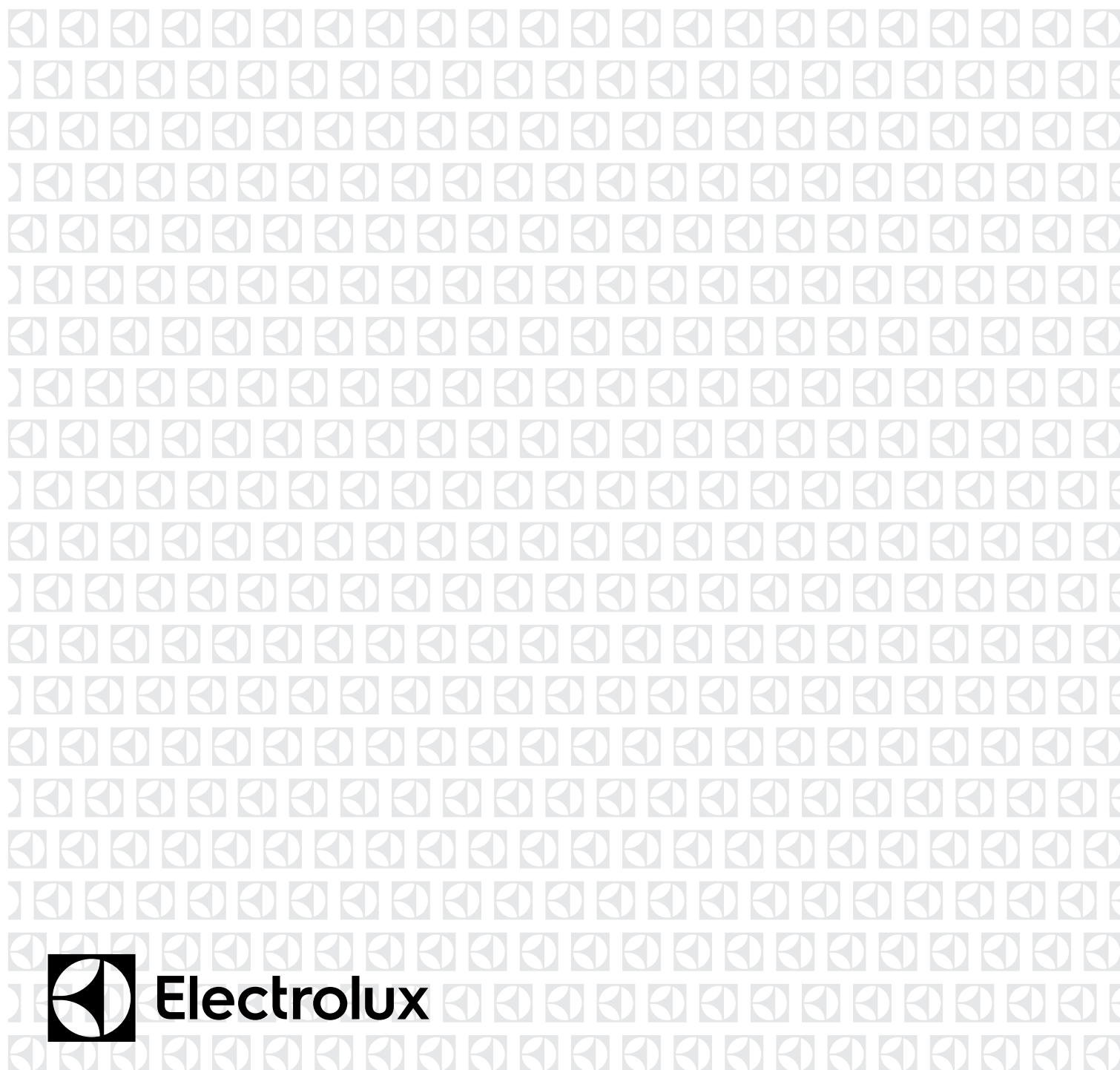

CONGRATULATIONS

Thank you for purchasing an Electrolux appliance. You've chosen a product that brings with it decades of professional experience and innovation. Ingenious and stylish, it has been designed with you in mind. So whenever you use it, you can be safe in the knowledge that you'll get great results every time.

Welcome to Electrolux.

The symbols you will see in this booklet have these meanings:



WARNING

This symbol indicates information concerning your personal safety.



CAUTION

This symbol indicates information on how to avoid damaging the cooktop.



IMPORTANT

This symbol indicates tips and information about use of the cooktop.



ENVIRONMENT

This symbol indicates tips and information about economical and ecological use of the cooktop.

BEFORE USING YOUR APPLIANCE

Before you use the cooktop, we recommend that you read through the whole user manual which provides the description of the cooktop and its functions. To avoid the risks that are always present when you use a gas appliance, it is important that the cooktop is installed correctly and that you read the safety instructions carefully to avoid misuse and hazards.

For future reference, please store this booklet in a safe place.

CONDITIONS OF USE

This appliance is intended to be used in household and similar applications such as:

- Staff kitchen areas in shops, offices and other working environments
- Farm houses
- By clients in hotels, motels and other residential type environments
- Bed and breakfast type environments

CONTENTS

Safety information	3
Product Description	5
Cooking surface layout	5
Control panel layout	6
Touch control sensor fields	6
Heat setting displays	7
Operating instructions	8
Tips on cooking and frying	13
Care and cleaning	14
Troubleshooting	15
Technical Data	16
Installation instructions	17
Assembly	18
Warranty	19

BEFORE YOU CALL

Please ensure you read the instruction manual fully before you call for service, or a full service fee could be applicable.

RECORD MODEL AND SERIAL NUMBER HERE:

Model:

Serial No:

IMPORTANT INFORMATION THAT MAY IMPACT YOUR MANUFACTURER'S WARRANTY

Adherence to the directions for use in this manual is extremely important for health and safety. Failure to strictly adhere to the requirements in this manual may result in personal injury, property damage and affect your ability to make a claim under the Electrolux manufacturer's warranty provided with your product. Products must be used, installed and operated in accordance with this manual. You may not be able to claim on the Electrolux manufacturer's warranty in the event that your product fault is due to failure to adhere this manual.

SAFETY INFORMATION

Please read the user manual carefully and store in a handy place for later reference. Pass the user manual on to possible new owners of the cooktop.

Read the following carefully to avoid damage or injury.

 **This symbol indicates never to do this**

 **This symbol indicates always do this**







General safety





WARNING!

Please comply with these instructions. If you do not, any damage resulting is not covered by the warranty.

Correct use

	This appliance is not intended for use by persons (including children) with reduced physical, sensory or mental capabilities, or lack of experience and knowledge, unless they have been given supervision or instruction concerning use of the appliance by a person responsible for their safety.
	Do not leave the appliance unattended during operation.
	This appliance should be used only for normal domestic cooking and frying of food.
	The appliance must not be used as a work surface or as a storage surface.
	Additions or modifications to the appliance are not permitted.
	Do not place or store flammable liquids, highly inflammable materials or fusible objects (e.g. plastic film, plastic, aluminium) on or near the appliance.

Children's safety





	The cooking zones will become hot when you cook. Therefore, always keep small children away from the appliance.
	The appliance is not intended for use by young children or infirm persons without supervision.
	Children should be supervised to ensure that they do not play with the appliance.







WARNING!

Accessible parts will become hot during use. To avoid burns young children should be kept away

Correct operation

	Always monitor the appliance during operation. Do not use an external timer or a separated remote control system to operate the appliance.
	Only use the appliance for domestic cooking tasks..
	Do not use the appliance as a work or a storage surface.
	Do not put or keep very flammable liquids and materials, or fusible objects (made of plastic or aluminium) on or near the appliance.
	Other than the connection point in the terminal block, do not let the electrical supply cord touch the appliance or hot cookware. Ensure electrical supply cord is not tangled.

General safety

	The appliance may only be installed and connected by trained, registered service engineers.
	Built-in appliances may only be used after they have been built into suitable built-in units and work surfaces that meet standards.
	In the event of faults with the appliance or damage to the glass ceramic (cracks, scratches or splits), the appliance must be switched off and disconnected from the electrical supply, to prevent the possibility of an electric shock.
	Repairs to the appliance must only be carried out by trained registered service engineers.

SAFETY INFORMATION (CONTINUED)

Safety during use

- ✔ Remove stickers and film from the glass ceramic.
- ⊘ There is the risk of burns from the appliance if used carelessly.
- ⊘ Cables from electrical appliances must not touch the hot surface of the appliance or hot cookware.
- ⊘ Overheated fats and oils can ignite very quickly. Warning! Fire hazard!
- ✔ Switch the cooking zones off after each use.



WARNING

If the surface is cracked, switch off the appliance to avoid possibility of electric shock.

Safety when cleaning

- ✔ For cleaning, the appliance must be switched off and cooled down.
- ⊘ For safety reasons, the cleaning of the appliance with steam jet or high pressure cleaning equipment is not permitted.

How to avoid damage to the appliance

- ⊘ The glass ceramic can be damaged by objects falling onto it.
- ⊘ The edge of the glass ceramic can be damaged by being knocked by the cookware.
- ⊘ Cookware made of cast iron, cast aluminium or with damaged bottoms can scratch the glass ceramic if pushed across the surface.
- ✔ Before spillage can become burnt on to the cooking surface, remove it with a damp cloth.
- ✔ To avoid damaging cookware and glass ceramics, do not allow saucepans or frying pans to boil dry.
- ⊘ Do not use the cooking zones with empty cookware or without cookware.
- ⊘ Do not let cookware boil dry to prevent damage to cookware and the ceramic glass.
- ⊘ Do not cover the parts of the appliance with aluminium foil.
- ⊘ Please note: Damage including broken glass or scratches caused by misuse outlined above is not covered under warranty.

PRODUCT DESCRIPTION

COOKING SURFACE LAYOUT

EHC644BB

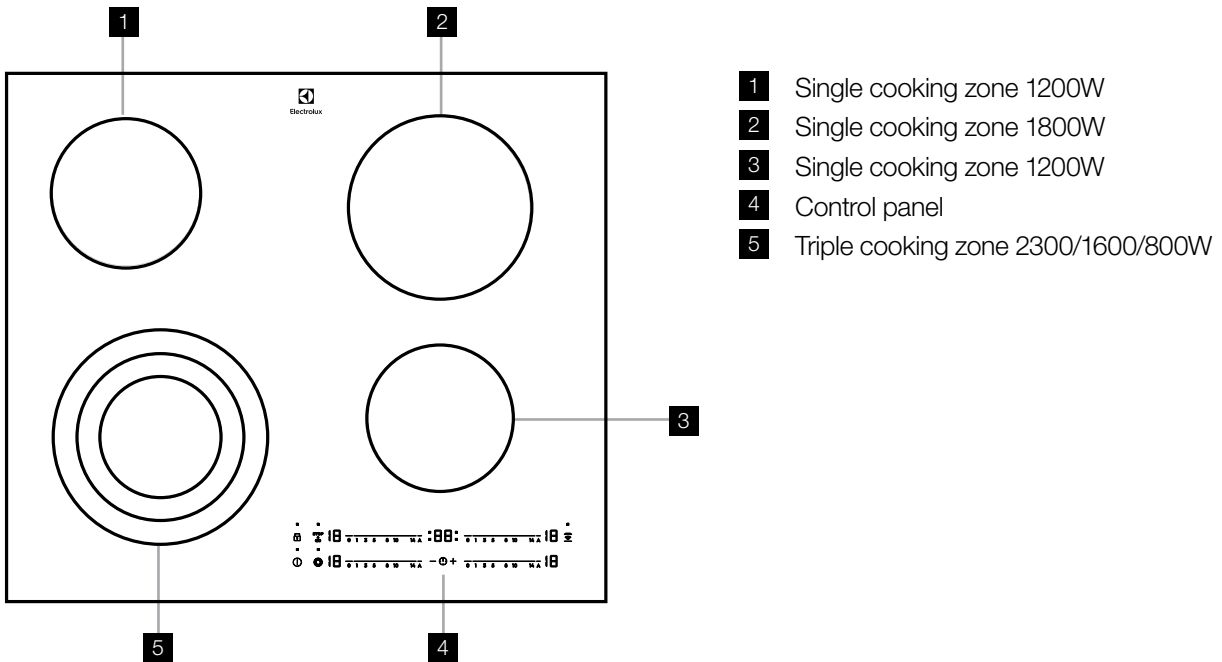

EHC944BB

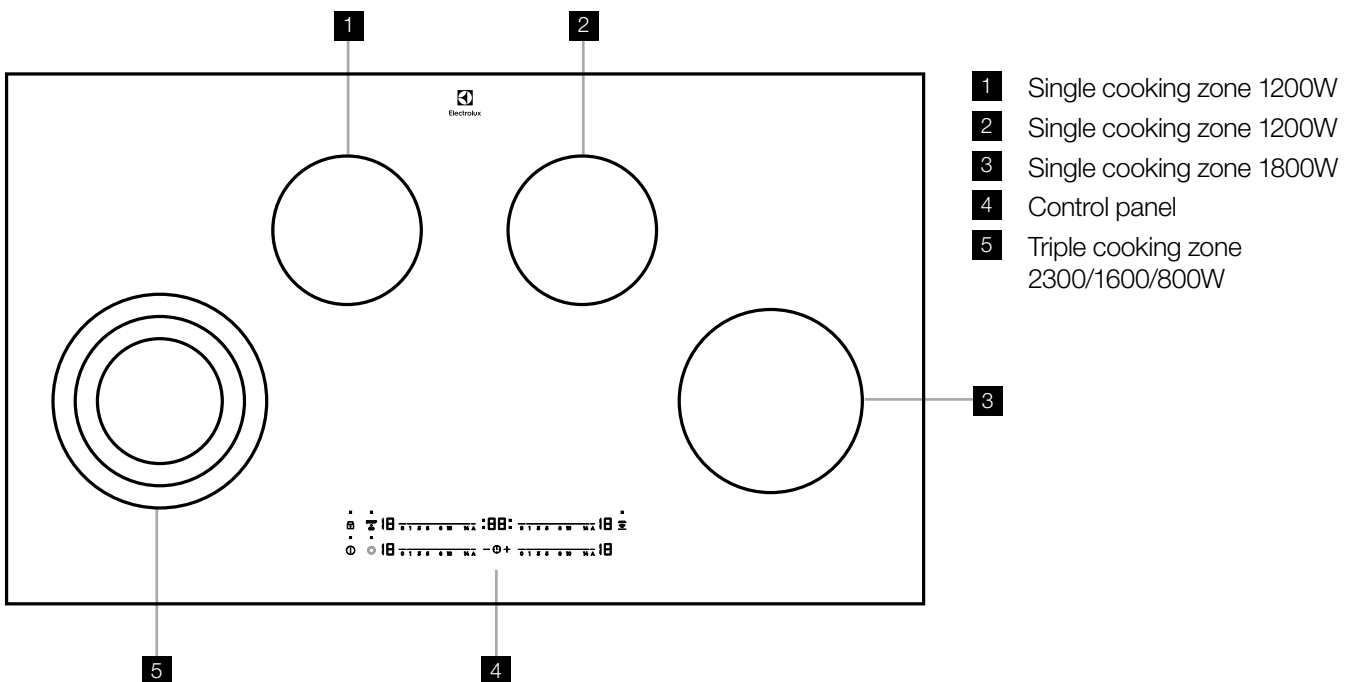

PRODUCT DESCRIPTION (CONTINUED)

CONTROL PANEL LAYOUT

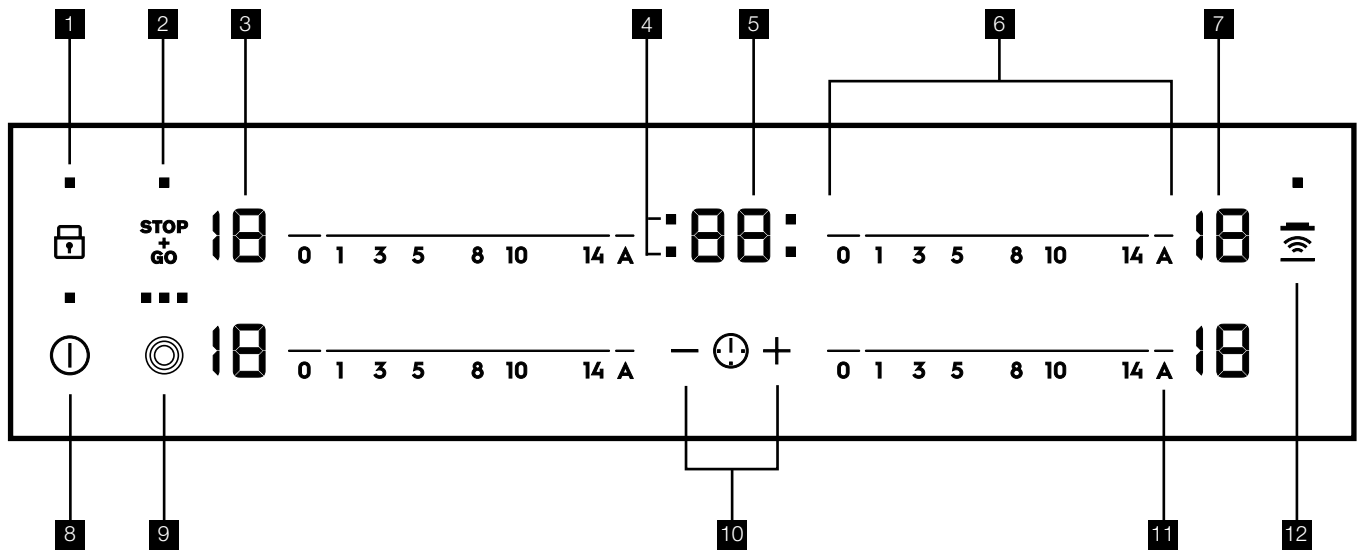

- 1** Lock with pilot light
- 2** Sets all operating zones to a keep warm setting
- 3** Display
- 4** Cooking zone indicators of Timer
- 5** Timer display
- 6** Control bar to set a heat setting
- 7** Heat setting display
- 8** On/Off with power indicator
- 9** Triple ring cooking zone
- 10** Timer
- 11** To activate and deactivate the Automatic heat up function
- 12** To activate and deactivate the manual mode of the Hob²Hood function









TOUCH CONTROL SENSOR FIELDS

The appliance is operated using Touch Control sensor fields. Functions are controlled by touching sensor fields and confirmed by displays and acoustic signals. Touch the sensor fields from below, without covering other sensor fields.

		Sensor field	Function
8	ⓘ	On / Off	To switch the appliance on and off
6	— — —	Control bar	To set a heat setting
10	⌚	Timer	To select timer settings
10	+	Increase settings	To increase Timer time
10	-	Reduce settings	To reduce Timer time
1	🔒	Lock	To lock/unlock the control panel
9	⊙	Triple ring switch	To switch outer rings on and off

PRODUCT DESCRIPTION (CONTINUED)

HEAT SETTING DISPLAYS

Display		Description
		Cooking zone is switched off
	Keep warm setting	Keep warm setting is set
	Heat settings	Heat setting is set
	Automatic warm up function	Automatic warm-up function is activated
	Error	Malfunction has occurred
	OptiHeat Control	3 step residual heat indicator – continue cooking / keep warm / residual heat
	Child safety device	Lock/child safety device is activated
	Automatic switch off	Switch off is active

OPTIHEAT CONTROL (3 STEP RESIDUAL HEAT INDICATOR)

WARNING!





 There is a risk of burns from residual heat. The indicator shows the level of the residual heat.

IMPORTANT!

Residual heat can be used for melting and keeping food warm.

OPERATING INSTRUCTIONS

Switching the appliance on and off

	Control panel	Display	Pilot light
Switch on	Touch  for 2 seconds	 / 	lights up
Switch off	Touch  for 2 seconds	 / none	goes out



IMPORTANT!

After switching on, within approx. 10 seconds a heat setting or a function must be set, otherwise the appliance automatically switches itself off.

Setting the heat setting

To set or change the heat setting: touch the control bar at the correct heat setting or move your finger along the control bar until you reach the correct heat setting.

IMPORTANT!

The keep warm setting  lies between  and . It is used to keep food warm.

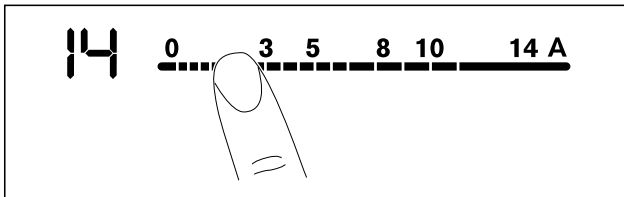

Switching the outside ring on and off

By switching the outside rings on or off, the effective heating surface can be matched to the size of the cookware. There are three indicators on the control panel that show which rings have been activated.

To activate the inner ring: touch the sensor field.
The left indicator comes on.

To activate the centre ring: touch the same sensor field again.
The middle indicator comes on.

To activate the outer ring: touch the sensor field again.
The right indicator comes on.

To deactivate the outer ring: touch the sensor field until the indicator goes out.

Ring activation indicators

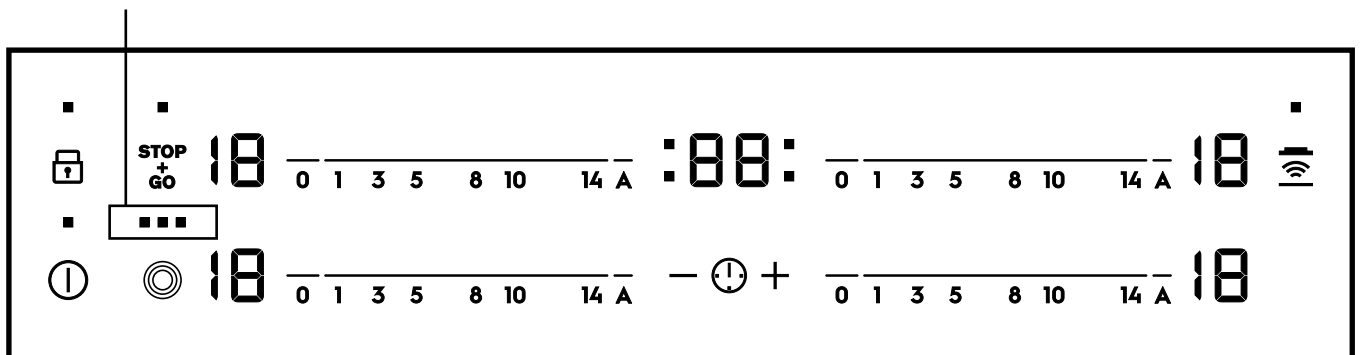



OPERATING INSTRUCTIONS (CONTINUED)

i IMPORTANT!

When you activate the zone but do not activate the outer ring the light that comes out from the zone may cover the outer ring. It does not mean that the outer ring is activated. To see if the ring is activated check the indicator.

Locking/unlocking the control panel

The control panel, with the exception of the "On/Off" sensor field, can be locked at any time in order to prevent the settings being changed e.g. by wiping over the panel with a cloth.



	Control panel	Display
Switch on	Touch 	 (for 5 seconds)
Switch off	Touch 	the previously set heat setting

i IMPORTANT!

When you switch the appliance off, the locking function is automatically switched off.

Using the automatic heat up function

Activate this function to get a desired heat setting in a shorter time. When it is on, the zone operates at the highest setting in the beginning and then continues to cook at the desired heating setting.

To activate the function for a cooking zone, press **A** . ( comes on). Immediately touch a desired heat setting. After 3 seconds,  comes on.



i IMPORTANT!

To activate the function, the cooking zone must be cold.





The child safety device

The child safety device prevents unintentional use of the appliance.

Switching on the child safety device:

- Start the hob with . Do not set the heat settings.
- Touch  for 4 seconds. The symbol  comes on.
- The child safety device is switched on.

Switching off the child safety device:





- Start the hob with . Do not set the heat settings. Touch  for 4 seconds. The symbol  comes on.
- Stop the hob with .
- The child safety device is switched off.

i IMPORTANT!

The child safety device can only be switched on and off, if no heat setting is set.

Overriding the child safety device:

The child safety device can be switched off in this way for a single cooking session; it remains activated afterwards.

- Start the hob with . The symbol  comes on.
- Touch  for 4 seconds. The symbol  comes on.

Until the appliance is next switched off, it can be used as normal. After switching off the appliance, the child safety device is active again.

i IMPORTANT!

After overriding the child safety device, a heat setting or a function must be set within approx. 10 seconds, otherwise the appliance automatically switches itself off.

OPERATING INSTRUCTIONS (CONTINUED)

Hob²Hood

This is an advanced automatic function which connects the hob to a special hood. Both the hob and the hood have an infra-red signal communicator. The speed of the fan is defined automatically on the basis of the mode setting and the temperature of the hottest cooking zone on the hob. You can also operate the fan from the hob manually.

i IMPORTANT!

For most hoods, the remote system is originally deactivated. Activate it before you use the function. For more information refer to your hood user manual.

Operating the function automatically





The default automatic mode from the factory is H5. You can change the automatic mode by following the instructions below. When you activate the job the hood will adjust the fan speed automatically. Please note the below table is a guide, the fan speed varies depending on the temperature measured on the cooking zones of the cooktop which can be affected by the heat setting(s) selected as well as the size and volume of what you are cooking.

Automatic modes

	Automatic light	Boiling¹⁾	Frying²⁾
Mode H0	Off	Off	Off
Mode H1	On	Off	Off
Mode H2 ³⁾	On	Fan speed 1	Fan speed 1
Mode H3	On	Off	Fan speed 1
Mode H4	On	Fan speed 1	Fan speed 1
Mode H5	On	Fan speed 1	Fan speed 2
Mode H6	On	Fan speed 2	Fan speed 3

1. The hob detects the boiling process and activates fan speed in accordance with automatic mode.
2. The hob detects the frying process and activates fan speed in accordance with automatic mode.
3. This mode activates the fan and the light and does not rely on the temperature.

Changing the automatic mode

1. Deactivate the appliance
2. Touch  for 3 seconds. The display comes on and goes off.
3. Touch  for 3 seconds.
4. Touch  a few times until  comes on.
5. Touch  of the Timer to select an automatic mode.

i IMPORTANT!

To operate the hood directly on the hood panel, deactivate the automatic mode of the function.

When you finish cooking and deactivate the hob, the hood fan may still operate for a certain period of time. After that time the system deactivates the fan automatically and prevents you from accidental activation of the fan for the next 30 seconds.

OPERATING INSTRUCTIONS (CONTINUED)

Using the timer





Function	Condition	Outcome after the time has elapsed
Automatic cut-out	A heat setting is set	Acoustic signal 00 flashes Cooking zone switches off
Countdown timer	Cooking zones not in use	Acoustic signal 00 flashes

i IMPORTANT!

If a heat setting is set on this cooking zone in addition to a countdown timer, the cooking zone is switched off after the time set has elapsed.

i IMPORTANT!

If a cooking zone is switched off, the timer function set is also switched off.

Step	Control panel	Display
1	Touch  once	Pilot light of the first cooking zone flashes .00
2	Touch  once	Pilot light of the second cooking zone flashes ˙00
3	Touch  once	Pilot light of the third cooking zone flashes 00˙
4	Touch  once	Pilot light of the fourth cooking zone flashes 00.

i IMPORTANT!

If the pilot light is flashing more slowly, the heat setting can be set or modified.

i IMPORTANT!

If other timer functions are set, after a few seconds the shortest remaining time of all the timer functions is displayed and the corresponding pilot light flashes.

Setting the time



Step	Control panel	Indicator
1	Select  cooking zone	Pilot light for the cooking zone selected flashes
2	Touch + or -	00 to 99 minutes
After a few seconds the pilot light flashes more slowly. The time is set. The time counts down.		

Switching off the timer function

Step	Control panel	Indicator
1	Select  cooking zone	Pilot light for the cooking zone selected flashes
2	Touch -	The time remaining counts backwards to 00
After a few seconds the pilot light flashes more slowly. The time is set. The time counts down.		

OPERATING INSTRUCTIONS (CONTINUED)

Changing the time

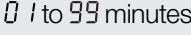
Step	Control panel	Indicator
1	Select  cooking zone	Pilot light of the selected cooking zone flashes faster. Time remaining is displayed
2	Touch  or 	 minutes
After a few seconds the pilot light flashes more slowly. The time is set. The time counts down.		

Displaying the time remaining for a cooking zone

Control panel field	Display
Select  cooking zone	Pilot light of the cooking zone selected flashes faster The time remaining is displayed
After a few seconds the pilot light flashes more slowly.	









Switching off the acoustic signal

Control panel field	Display
Touch 	The acoustic signal to acknowledge.
The acoustic signal stops.	

Automatic switch off

The function deactivates the hob automatically if:

- All cooking zones are deactivated
- You do not set the heat setting after you activate the hob,
- You spill something or put something on the control panel for more than 10 seconds (a pan, a cloth, etc.). An acoustic signal sounds and the hob deactivates. Remove the object or clean the control panel.
- You do not deactivate a cooking zone or change the heat setting. After some time  comes on and the hob deactivates.

Heat setting	The hob deactivates after
 ,  - 	6 hours
 - 	5 hours
 - 	4 hours
 - 	1.5 hours

TIPS ON COOKING AND FRYING

Information on acrylamides

According to the latest scientific knowledge, intensive browning of food, especially in products containing starch, can constitute a health risk due to acrylamides. Therefore we recommend cooking at the lowest possible temperatures and not browning foods too much.

Cookware

- You can recognise good cookware from the bottoms of the pans. The bottom should be as thick and flat as possible.
- Cookware made of enamelled steel or with aluminium or copper bottoms can leave discolorations on the glass ceramic surface which are difficult or impossible to remove.



Energy saving

- Always place cookware on the cooking zone before it is switched on.
- Switch cooking zones off before the end of the cooking time, to take advantage of residual heat.
- If possible, always place lids on the pans.

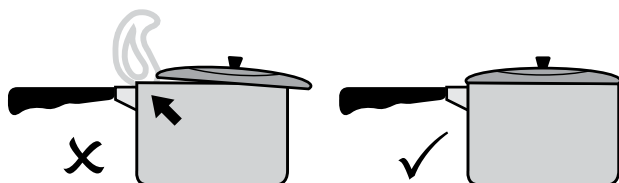

- Bottom of pans and cooking zones should be the same size.

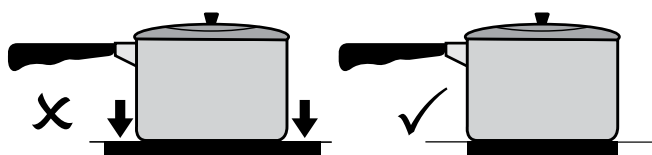

CARE AND CLEANING

WARNING!

Watch out! Risk of burns from residual heat.

WARNING!

Sharp objects and abrasive cleaning materials will damage the appliance. Clean with water and washing up liquid.

WARNING!

Sharp cleaning agents will damage the appliance. Remove residues with water and washing up liquid.

Cleaning the appliance after each use

1. Wipe the appliance with a damp cloth and a little washing up liquid.
2. Rub the appliance dry using a clean cloth.

Removing deposits

Type of dirt	Remove		
	At once	When the appliance has cooled down	Using
Sugar, food containing sugar	Yes	---	A scraper ¹⁾
Plastics, tin foil	Yes	---	A scraper ¹⁾
Limescale and water rings	---	Yes	Cleaner for glass ceramic or stainless steel ¹⁾
Fat splashes	---	Yes	Cleaner for glass ceramic or stainless steel ¹⁾
shiny metallic discoloration	---	Yes	Cleaner for glass ceramic or stainless steel ¹⁾

¹⁾ *Scrapers and cleaners for glass ceramic and stainless steel can be purchased in specialized shops.

Removing deposits

1. Place a scraper on the glass ceramic surface at an angle.
2. Remove residues by sliding the blade over the surface.
3. Wipe the appliance with a damp cloth and a little washing up liquid.
4. Rub the appliance dry using a clean cloth.

IMPORTANT!

Remove stubborn residues with a cleaner for glass ceramic or stainless steel.









IMPORTANT!

Scratches or dark stains on the glass ceramic that cannot be removed do not however affect the functioning of the appliance.

WARNING!

Residues from cleaning agents will damage the appliance. Remove residues with water and washing up liquid.

TROUBLESHOOTING

Problem	Possible cause	Remedy
Red rings, limescale or water rings, shiny metallic or other discolouration, scratches/shadows, bubbles or other miscellaneous marks or stains on ceramic glass cooktop surface.	Cooktop surface has not been cleaned correctly. Cleaning of the cooktop surface is not covered under warranty. If a service call is placed to clean the cooktop you will be charged for the visit.	Use a ceramic glass cleaner such as Cerapol.
Pitting of ceramic glass surface.	Spillovers of liquid with high sugar content.	These types of spills must be removed immediately with a special scraper for the glass. If not permanent damage to the cooktop glass can occur which is not covered under warranty.
The cooking zones will not switch on or are not functioning.	<ul style="list-style-type: none"> • More than 10 seconds have passed since the appliance was switched on. 	Switch the appliance on again.
	<ul style="list-style-type: none"> • The child safety device is switched on . 	Deactivate the child safety device (See the section "Child safety device").
	<ul style="list-style-type: none"> • Several sensor fields were touched at the same time. 	Only touch one sensor field.
	<ul style="list-style-type: none"> • Automatic switch off has been triggered. 	Remove any objects (pan, cloths, etc.) that are lying on the control panel. Switch the appliance on again.
	<ul style="list-style-type: none"> • The lock is switched on . 	Switch off the lock (See the section "Locking/unlocking the control panel").
Acoustic signal sounds when appliance is switched off.	The control panel is wholly or partly covered by objects.	Remove objects.
The residual heat indicator is not displaying anything.	The cooking zone was only on for a short time and is therefore not hot.	If the cooking zone is supposed to be hot, call the Customer Service Department.
The automatic warm up function is not switching itself on.	<ul style="list-style-type: none"> • There is still residual heat on the cooking zone . 	Let the cooking zone cool down.
	<ul style="list-style-type: none"> • The highest heat setting is set . 	The highest heat setting has the same power as the automatic warm up function.
	<ul style="list-style-type: none"> • The heat setting was set using the sensor field . 	<ol style="list-style-type: none"> 1. Switch off the cooking zone 2. Set the cooking zone using the sensor field .
Acoustic signal sounds and appliance switches itself on and then off again; after 5 seconds another acoustic signal sounds.	The On/Off sensor field has been covered up, e.g. by a cloth.	Do not place any objects on the control panel.
 is lit.	<ul style="list-style-type: none"> • Overheating protection for the cooking zone has been triggered. 	Switch off the cooking zone. Switch the cooking zone on again.
	<ul style="list-style-type: none"> • Automatic switch off has been triggered. 	Switch off the cooking zone. Switch the cooking zone on again.
 and number are displayed.	Electronics fault.	Disconnect the appliance from the electrical supply for a few minutes (Take the fuse out of the house's wiring system) If after switching on again,  is displayed again, call the customer service department.

If you are unable to remedy the problem by following the above suggestions, please contact your dealer or the Customer Care Department.

WARNING!

Repairs to the appliance are only to be carried out by qualified service engineers. Considerable danger to the user may result from improper repairs.

IMPORTANT!

If the appliance has been wrongly operated, the visit from the customer service technician or dealer may not take place free of charge, even during the warranty period.

TECHNICAL DATA

Model	EHC644BB	EHC944BB		
PNC	949 163 396	949 163 397		
Product dimensions (w x d) mm	590 x 520	900 x 520		
Cut-out dimensions (w x d) mm	560 x 490 (485)	880 x 490 (485)		
Frequency (Hz)	50 / 60	50 / 60		
Voltage (volts)	220-240	220-240		
Cycles (Hz)	50	50		
Service Cord	Not fitted	Not fitted		
Elements	No. zones	Watts	No. zones	Watts
Left front	3	2300/1600/800	3	2300/1600/800
Left rear	1	1200	1	1200
Right front	1	1200	1	1200
Right rear	1	1800	1	1800
Total		6500		6500



ENVIRONMENT!

Disposal

The symbol  on the product or on its packaging indicates that this product may not be treated as household waste. Instead it should be taken to the appropriate collection point for the recycling of electrical and electronic equipment. By ensuring this product is disposed of correctly, you will help prevent potential negative consequences for the environment and human health, which could otherwise be caused by inappropriate waste handling of this product. For more detailed information about recycling of this product, please contact your local council, your household waste disposal service or the shop where you purchased the product.

Packaging material

The packaging materials are friendly to the environment and can be recycled. The plastic components are identified by marking: >PE<,>PS<, etc. Discard the packaging materials as household waste at the waste disposal facilities in your municipality.

INSTALLATION INSTRUCTIONS

WARNING!

This must be read! The laws, ordinances, directives and standards in force in the country of use are to be followed (safety regulations, proper recycling in accordance with the regulations, etc.)

IMPORTANT!

Installation may only be carried out by a qualified electrician. The minimum distances to other appliances and units are to be observed.

Anti-shock protection must be provided by the installation, for example drawers may only be installed with a protective floor directly underneath the appliance.

The cut surfaces of the worktop are to be protected against moisture using a suitable sealant. The sealant seals the appliance to the work top with no gap. Do not use silicon sealant between the appliance and the work top. Avoid installing the appliance next to doors and under windows. Otherwise hot cookware may be knocked off the rings when doors and windows are opened.

WARNING!

Risk of injury from electrical current.

- The electrical mains terminal is live.
- Make electrical mains terminal free of voltage.
- Follow connection schematic.
- Observe electrical safety rules.
- Ensure anti-shock protection by installing correctly.
- The appliance must be connected to the electrical supply by a qualified electrician.
- Loose and inappropriate plug and socket connections can make the terminal overheat.
- Have the clamping connections correctly installed by a qualified electrician.
- Use strain relief clamp on cable.

WARNING!

The surface temperature exceeds 95°C. To avoid a hazard, underbench access must be restricted.

Electrical Connection

Before connecting, check that the nominal voltage of the appliance, that is the voltage stated on the rating plate, corresponds to the available supply voltage. Also check the power rating of the appliance and ensure that the wire is suitably sized in accordance with local wiring rules to suit the appliance power rating. The rating plate is located on the lower casing of the hob. The heating element voltage is AC230V~. The appliance also works perfectly on networks with AC220V~ or AC240V~. Means for disconnection must be incorporated in the fixed wiring in accordance with local wiring rules. The hob is to be connected to the mains using a device that allows

the appliance to be disconnected from the mains at all poles with a contact opening width of at least 3 mm, eg. automatic line protecting cut-out, earth leakage trips or fuse. If this appliance's mains cable is damaged, it must be replaced by a special cable (type H05BB-F Tmax 90°C; or higher). The latter is available from the Customer Care Department. The connection must be carried out as shown in the diagram. The connecting links should be fitted according to the appropriate connection diagram. The earth lead is connected to terminal. The earth lead must be longer than leads carrying electric current. **The cable connections must be made in accordance with regulations and the terminal screws tightened securely.** Finally, the connecting cable is to be secured with the mains cable cleat and the covering closed by pressing firmly (lock into place). Before switching on for the first time, any protective foil or stickers must be removed from the glass ceramic surface.

WARNING!

Once connected to the mains supply check that all cooking zones are ready for use by briefly switching each on in turn at the maximum setting.

- A duplicate rating label is supplied with this unit. For easy identification of this unit after installation, stick it to a readily available surface adjacent to the cooktop.

Sticking on the seal

- Clean the worktop around the cutout area.
- Stick the single-sided adhesive sealing tape provided on the underside of the hob around the outside edge ensuring that it is not stretched. The two ends of the tape should join in the middle of one side. After trimming the tape (allow it to overlap by 2-3 mm), press the two ends together.

IMPORTANT!

The cut-out section in the worktop is illustrated in the drawing with the dimensions 560 x 490 / 880 x 490 mm. The appliance can also be built into a shorter cut-out section with the dimensions 560 x 485 / 880 x 485 mm.

ASSEMBLY

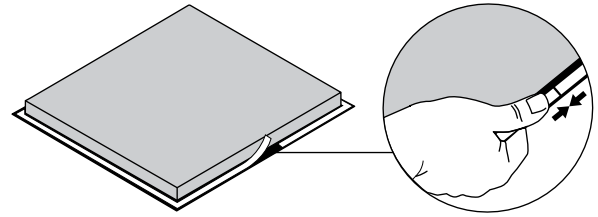
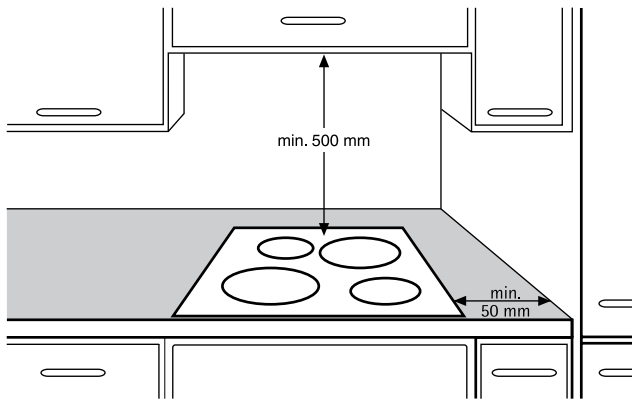

EHC644BB

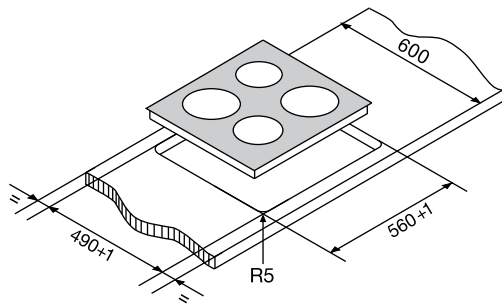

EHC944BB

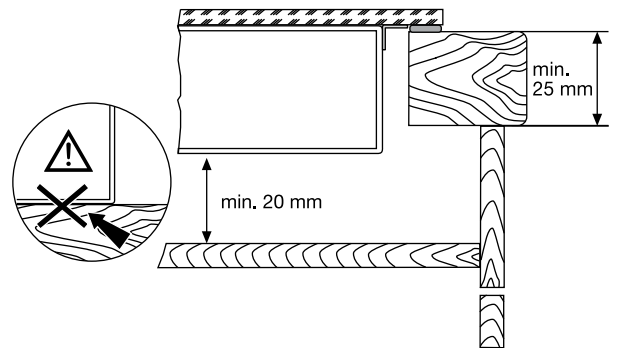
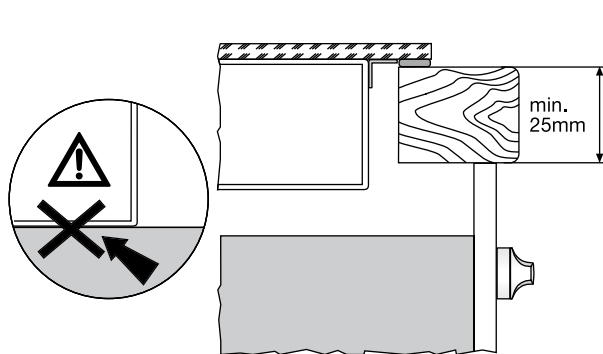
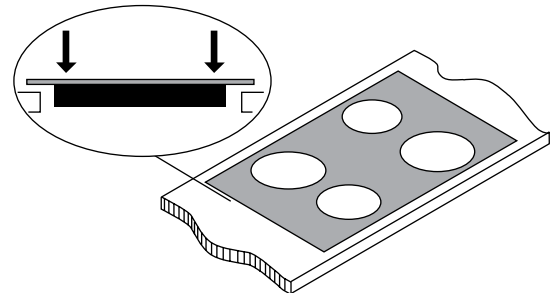
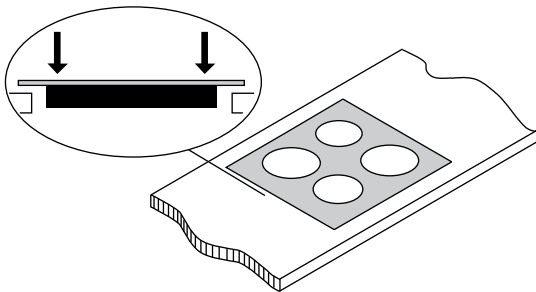
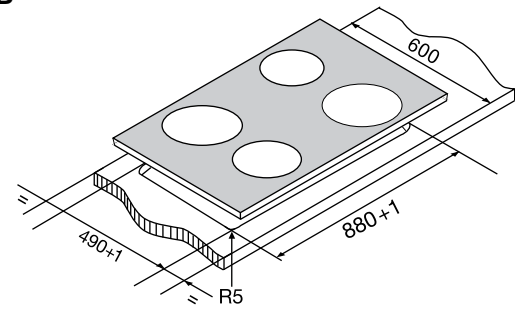

! WARNING!

Surface temperatures of base exceed 95°C, under bench access must be restricted by use of non-combustible barrier on installation

Electrolux Warranty

FOR SALES IN AUSTRALIA AND NEW ZEALAND
 APPLIANCE: ELECTROLUX BUILT-IN OVENS, COOKTOPS AND
 FREESTANDING COOKER

This document sets out the terms and conditions of the product warranties for Electrolux Appliances. It is an important document. Please keep it with your proof of purchase documents in a safe place for future reference should there be a manufacturing defect in your Appliance. This warranty is in addition to other rights you may have under the Australian Consumer Law.

1. In this warranty:

- (a) 'ACL' or 'Australian Consumer Law' means Schedule 2 to the Competition and Consumer Act 2010;
- (b) 'Appliance' means any Electrolux product purchased by you and accompanied by this document;
- (c) 'ASC' means Electrolux's authorised serviced centres;
- (d) 'Electrolux' is the brand controlled by Electrolux Home Products Pty Ltd of 163 O'Riordan Street, Mascot NSW 2020, ABN 51 004 762 341 in respect of Appliances purchased in Australia and Electrolux (NZ) Limited (collectively "Electrolux") of 3-5 Niall Burgess Road, Mount Wellington, in respect of Appliances purchased in New Zealand;
- (e) 'Warranty Period' means the period specified in clause 3 of this warranty;
- (f) 'you' means the purchaser of the Appliance not having purchased the Appliance for re-sale, and 'your' has a corresponding meaning.

2. Application: This warranty only applies to new Appliances, purchased and used in Australia or New Zealand and is in addition to (and does not exclude, restrict, or modify in any way) other rights and remedies under a law to which the Appliances or services relate, including any non-excludable statutory guarantees in Australia and New Zealand.

3. Warranty Period: Subject to these terms and conditions, this warranty continues in Australia for a period of 24 months and in New Zealand for a period of 24 months, following the date of original purchase of the Appliance.

4. Repair or replace warranty: During the Warranty Period, Electrolux or its ASC will, at no extra charge if your Appliance is readily accessible for service, without special equipment and subject to these terms and conditions, repair or replace any parts which it considers to be defective. Electrolux may, in its absolute discretion, choose whether the remedy offered for a valid warranty claim is repair or replacement. Electrolux or its ASC may use refurbished parts to repair your Appliance. You agree that any replaced Appliances or parts become the property of Electrolux.

5. Travel and transportation costs: Subject to clause 7, Electrolux will bear the reasonable cost of transportation, travel and delivery of the Appliance to and from Electrolux or its ASC. Travel and transportation will be arranged by Electrolux as part of any valid warranty claim.

6. Proof of purchase is required before you can make a claim under this warranty.

7. Exclusions: You may not make a claim under this warranty unless the defect claimed is due to faulty or defective parts or workmanship. This warranty does not cover:

- (a) light globes, batteries, filters or similar perishable parts;
- (b) parts and Appliances not supplied by Electrolux;
- (c) cosmetic damage which does not affect the operation of the Appliance;

- (d) damage to the Appliance caused by:
 - (i) negligence or accident;
 - (ii) misuse or abuse, including failure to properly maintain or service;
 - (iii) improper, negligent or faulty servicing or repair works done by anyone other than an Electrolux authorised repairer or ASC;
 - (iv) normal wear and tear;
 - (v) power surges, electrical storm damage or incorrect power supply;
 - (vi) incomplete or improper installation;
 - (vii) incorrect, improper or inappropriate operation;
 - (viii) insect or vermin infestation;
 - (ix) failure to comply with any additional instructions supplied with the Appliance;

In addition, Electrolux is not liable under this warranty if:

- (a) the Appliance has been, or Electrolux reasonably believes that the Appliance has been, used for purposes other than those for which the Appliance was intended, including where the Appliance has been used for any non-domestic purpose;
- (b) the Appliance is modified without authority from Electrolux in writing;
- (c) the Appliance's serial number or warranty seal has been removed or defaced

8. How to claim under this warranty: To enquire about claiming under this warranty, please follow these steps:

- (a) carefully check the operating instructions, user manual and the terms of this warranty;
- (b) have the model and serial number of the Appliance available;
- (c) have the proof of purchase (e.g. an invoice) available;
- (d) telephone the numbers shown below.

9. Australia: For Appliances and services provided by Electrolux in Australia: Electrolux goods come with guarantees that cannot be excluded under the Australian Consumer Law. You are entitled to a replacement or refund for a major failure and for compensation for any other reasonably foreseeable loss or damage. You are also entitled to have the Appliance repaired or replaced if the Appliance fails to be of acceptable quality and the failure does not amount to a major failure. 'Acceptable quality' and 'major failure' have the same meaning as referred to in the ACL.

10. New Zealand: For Appliances and services provided by Electrolux in New Zealand, the Appliances come with a guarantee by Electrolux pursuant to the provisions of the Consumer Guarantees Act, the Sale of Goods Act and the Fair Trading Act. Where the Appliance was purchased in New Zealand for commercial purposes the Consumer Guarantee Act does not apply.

11. Confidentiality: You accept that if you make a warranty claim, Electrolux and its agents including ASC may exchange information in relation to you to enable Electrolux to meet its obligations under this warranty.

Important Notice

Before calling for service, please ensure that the steps listed in clause 8 above have been followed.

<p>FOR SERVICE or to find the address of your nearest authorised service centre in Australia PLEASE CALL 13 13 49 <small>For the cost of a local call (Australia only)</small></p>	<p>AUSTRALIA ELECTROLUX HOME PRODUCTS 163 O'Riordan Street, Mascot NSW 2020 electrolux.com.au</p>	<p>FOR SPARE PARTS or to find the address of your nearest spare parts centre in Australia PLEASE 13 13 50 <small>For the cost of a local call (Australia only)</small></p>
<p>FOR SERVICE or to find the address of your nearest authorised service centre in New Zealand PLEASE CALL 0800 10 66 10 <small>(New Zealand only)</small></p>	<p>NEW ZEALAND ELECTROLUX (NZ) Limited 3-5 Niall Burgess Road, Mount Wellington electrolux.co.nz</p>	<p>FOR SPARE PARTS or to find the address of your nearest spare parts centre in New Zealand PLEASE 0800 10 66 20 <small>(New Zealand only)</small></p>

Electrolux Home Products Australia

telephone: 1300 363 640
fax: 1800 350 067
email: customercare@electrolux.com.au
web: electrolux.com.au

shop.electrolux.com.au



Electrolux Home Products New Zealand

telephone: 0800 436 245
fax: 0800 225 088
email: customercare@electrolux.co.nz
web: electrolux.co.nz



To add a touch of professional inspiration to your home, visit electrolux.com.au or electrolux.co.nz

electrolux.com.au



or electrolux.co.nz



A14095401 Rev.A

© 2018 Electrolux Home Products Pty Ltd.

EMAN_CGH_EHC644BB_EHC944BB_Mar18