

EVEP916SB
EFEP955SB
EFEP915SB

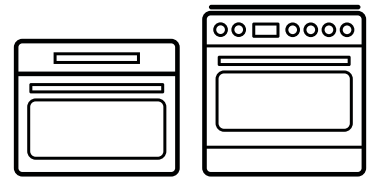

90cm Cooker

Installation & User manual

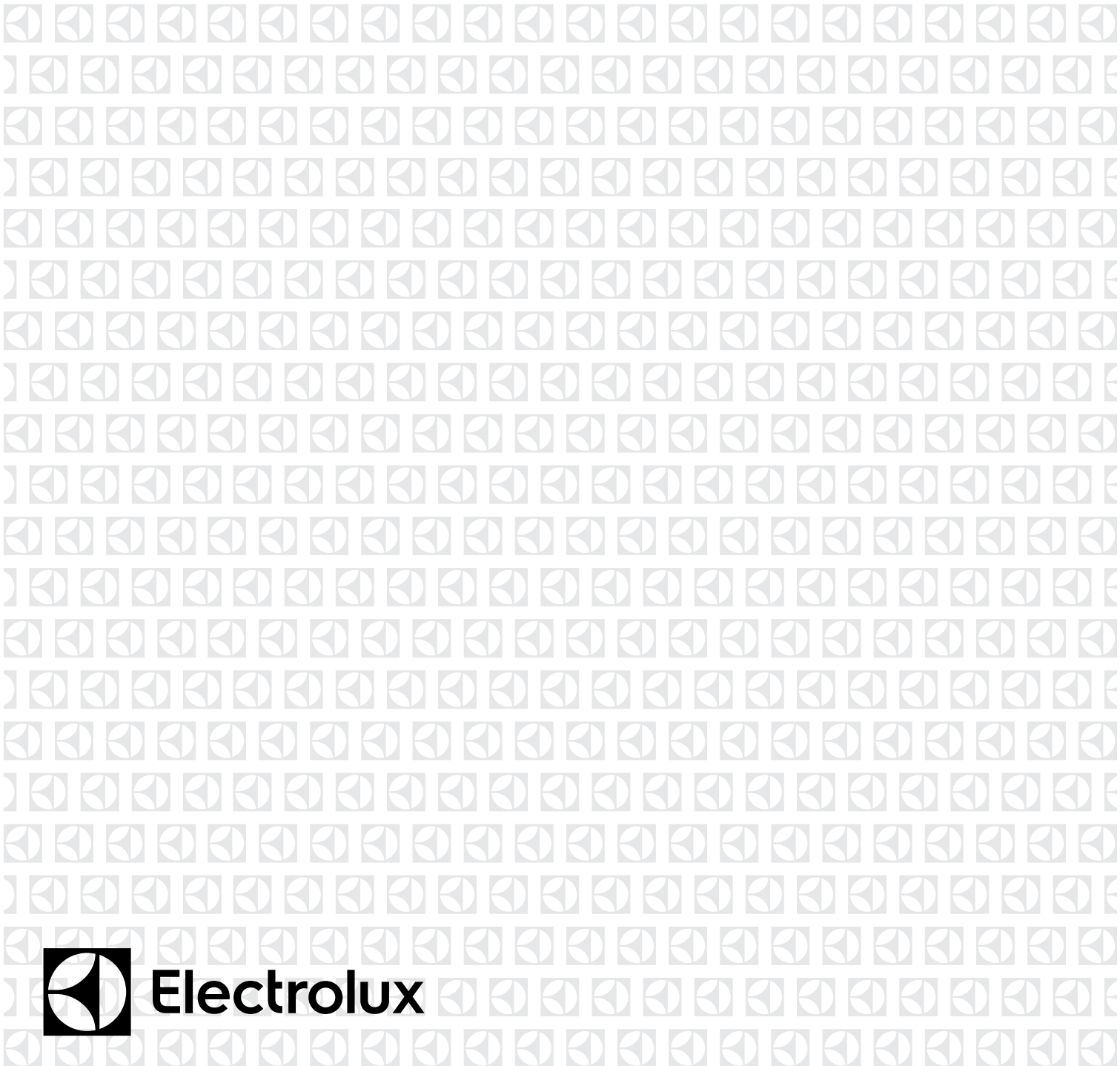

CONGRATULATIONS

Thank you for purchasing an Electrolux cooker. You've chosen a product that brings with it decades of professional experience and innovation. Ingenious and stylish, it has been designed with you in mind. So whenever you use it, you can be safe in the knowledge that you'll get great results every time.

Welcome to Electrolux.

BEFORE USING YOUR APPLIANCE

Check for any damage or marks. If you find the appliance damaged or marked you must report it within 7 days to claim for damages under the manufacturers warranty.

Before you use the appliance, we recommend that you read through the whole user manual which provides the description of the product and its functions. To avoid the risks that are always present when you use a gas appliance, it is important that the product is installed correctly and that you read the safety instructions carefully to avoid misuse and hazards.

For future reference, please store this booklet in a safe place.

This appliance complies with the requirements of Australian Standard AS/NZS 60335.2.6.

CONDITIONS OF USE

This appliance is intended to be used in household and similar applications such as:

- Staff kitchen areas in shops, offices and other working environments
- Farm houses
- By clients in hotels, motels and other residential type environments
- Bed and breakfast type environments.

BEFORE YOU CALL

Please ensure you read the instruction manual fully before you call for service, or a full service fee could be applicable.

RECORD MODEL AND SERIAL NUMBER HERE:

Model number: _____

Serial number: _____

CONTENTS

General warnings _____	3
Important safety instructions _____	4
EVEP916SB components _____	5
EFEP955SB components _____	6
EFEP915SB components _____	7
Before using your appliance for the first time _____	8
Installing your oven accessories _____	8
Using the oven _____	11
Oven baking guide _____	17
Oven cooking guide _____	18
Dealing with cooking problems _____	19
Oven cooking tips _____	20
Oven troubleshooting _____	21
Using the induction hob _____	22
Induction hob troubleshooting _____	28
Using the gas hob _____	30
Gas hob troubleshooting _____	31
Cleaning your appliance _____	32
Cleaning oven accessories _____	34
Installation of the appliance _____	36
Wiring requirements _____	43
Electrical and gas connections _____	44
Testing the operation of the gas cooker _____	46
Warranty _____	47

SYMBOLS



WARNING!

This symbol indicates information concerning your personal safety.



CAUTION!

This symbol indicates information on how to avoid damaging the appliance.



IMPORTANT!

This symbol indicates tips and information about use of the appliance.



ENVIRONMENT!

This symbol indicates tips and information about economical and ecological use of the appliance.

GENERAL WARNINGS

Please read the user manual carefully and store in a handy place for later reference. Pass the user manual on to possible new owners of the appliance.

Read the following carefully to avoid damage or injury.

NOTE: You must read these warnings carefully before installing or using the appliance. If you need assistance, contact your Customer Care Department. The manufacturer will not accept liability, should these instructions or any other safety instructions incorporated in this book be ignored.

WARNING!

- This appliance must not be used as a space heater.
- In order to avoid fire, the appliance must be kept clean and vents kept unobstructed.
- Do not spray aerosols in the vicinity of this appliance whilst it is in operation.
- Do not use or store flammable materials in this appliance storage compartment or near this appliance.
- Do not line the bottom of the oven with foil or cookware.
- Always use gloves when handling hot items inside the oven.
- Always turn the grill off immediately after use as fat left behind may catch fire.
- Do not hang any objects from the hob as it may block the air vents.
- Do not modify this appliance.
- To maintain safe operation, it is recommended that the product be inspected every 5 years by an authorised service person.
- Do not install an aftermarket lid or cover over this appliance.
- The appliance must be earthed.
- Switch the appliance off at the isolation switch before attempting to change the light globe.
- The cooking process must be supervised. A short term cooking process must be supervised continuously.

CAUTION!

Read the following carefully to avoid an electric shock or fire.

It is important to use your appliance safely. Check these safety points before using your appliance.

Installation, cleaning and servicing

- An authorised person must install this appliance. (Certificate of Compliance to be retained).
- Before using the appliance, ensure that all packing materials are removed from the appliance.
- In order to avoid any potential hazard, the enclosed installation instructions must be followed.
- Ensure that all specified vents, openings and airspaces are not blocked.
- Where the appliance is built into a cabinet, the cabinet material must be capable of withstanding 85°C.
- Only authorised personnel should carry out servicing. (Certificate of Compliance to be retained).
- Always ensure the appliance is switched off before cleaning or replacing parts.
- Do not use steam cleaners, as this may cause moisture build up.
- Always clean the appliance immediately after any food spillage.
- This appliance must be earthed.
- Due to the weight (freestanding 95-100kg, built in 70kg) and size of cookers, 2 persons are required to manually manoeuvre them. Remove loose items such as trivets, oven racks and trays to minimise weight.
- Do not use the oven door handle to lift the cooker, instead open the oven door and lift the roof of the oven cavity.
- Take care when lifting to avoid any sharp edges not intended for lifting.

INFORMATION ON DISPOSAL FOR USERS

ENVIRONMENT!

- Most of the packaging materials are recyclable. Please dispose of these materials through your local recycling depot or by placing them in appropriate collection containers.
- If you wish to discard this product, please contact your local authorities and ask for the correct method of disposal.

IMPORTANT SAFETY INSTRUCTIONS



WARNING!

OVEN

- During use the appliance becomes hot. Care should be taken to avoid touching the hot surfaces inside the oven.
- Always use gloves when handling hot items inside the oven.
- Switch the appliance off before removing the oven light glass for globe replacement.
- To avoid an accident, ensure that oven shelves and fittings are always inserted into the appliance in accordance with the instructions.
- Do not use the door as a shelf.
- Do not push down on the open oven door.
- Do not cover the grill insert with foil, as fat left there may catch fire.
- Always keep the grill dish clean as any fat there may catch fire.
- Always turn the grill off immediately after use, as fat left there may catch fire.
- Do not leave the grill on unattended.
- To avoid a fire, ensure the grill tray and fittings are always inserted into the appliance in accordance with the instructions.

GAS HOB MODEL

- Do not allow pots to boil dry, as damage to both pan and hob may result.
- Do not operate the cooktop for an extended period of time without a pot or pan on the burner.
- Do not allow large cookware to overhang the hob onto the adjacent benchtop. This will cause scorching to the benchtop surface.
- Ensure burner bodies and trivets are properly located.
- Unattended cooking with oil or fat on a hob can be dangerous and result in fire.
- In order to avoid a fire do not store items on the cooking surface.

INDUCTION HOB MODEL

- In order to avoid a fire do not store items on the cooking surface.
- Do not place heat resistant mats, wire mats or aluminium foil under pots and pans.
- Do not allow pots to boil dry, as damage to both pan and hob may result.
- Do not use the hob as extra bench space or as a cutting board.
- Do not allow large cookware to overhang the hob onto the adjacent benchtop. This will cause scorching to the benchtop surface.
- Do not slide pans across the surface of the ceramic glass as it could result in scratching of the surface.
- The induction hob is not intended to be operated by means of an external timer or separate remote-control system.
- Use only induction specific cookware.
- If the hob surface is cracked, switched off the appliance to avoid the possibility of electric shock.
- Metallic objects such as knives, forks, spoons and lids should not be placed on the hob surface since they can get hot.
- After use, switch off the hob element by its control and do not rely on automatic switch off.
- Unattended cooking with oil or fat on a hob can be dangerous and result in fire.
- The appliance is not intended to be operated by means of an external timer or remote control system.
- Users with an implanted pacemaker must keep their upper body minimum 30cm from induction cooking zones that are switched on.



WARNING!

CHILD SAFETY

- This appliance is not intended for use by persons (including children) with reduced physical, sensory or mental capabilities, or lack of experience and knowledge, unless they have been given supervision or instruction concerning use of the appliance by a person responsible for their safety.
- Children should be supervised to ensure that they do not play with the appliance.
- During use this appliance becomes hot. Care should be taken to avoid touching hot surfaces, eg. Oven door, heating elements, hobs or trivets.
- Accessible parts will also become hot when in use. To avoid burns and scalds children should be kept away.
- Always turn pan handles to the side or rear to prevent accidental knocking and to keep out of reach of children.

EVEP916SB COMPONENTS

Multi function electric oven and programmable controller

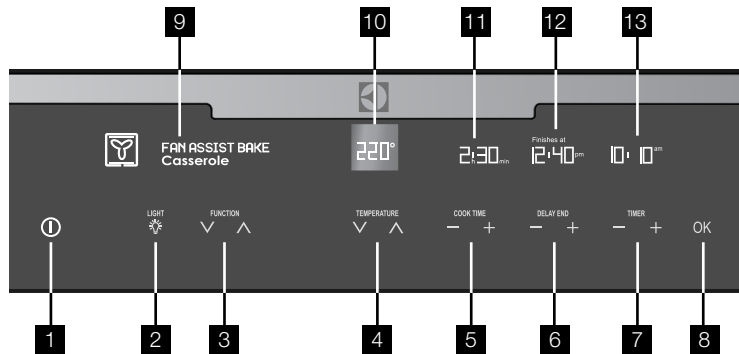

- | | | |
|------------------------------------|--------------------------------------|-----------------------------------|
| 1 ON/OFF | 5 Cook time control | 9 Cooking function display |
| 2 Light on/off | 6 Delay end control | 10 Temperature display |
| 3 Cooking function selector | 7 Set clock and timer control | 11 Cook time display |
| 4 Temperature control | 8 Instant confirm | 12 Delay end display |
| | | 13 Clock/timer display |



- | | | |
|-------------------------------------|------------------------------|---------------------------------|
| 14 Control panel (see above) | 15 Exhaust air outlet | 16 Quadruple glazed door |
|-------------------------------------|------------------------------|---------------------------------|

EFEP955SB COMPONENTS

Induction hob, multi function electric oven and programmable controller

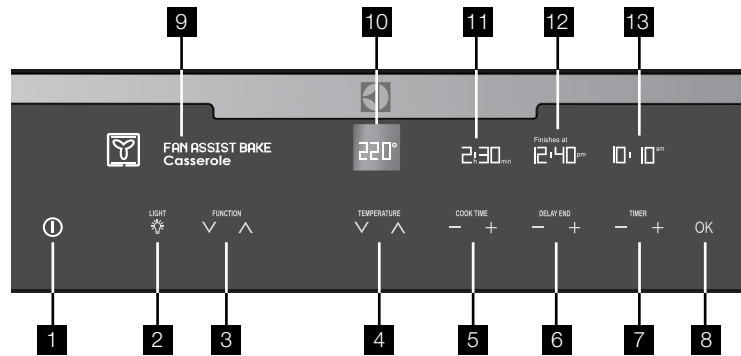

- | | | |
|------------------------------------|--------------------------------------|-----------------------------------|
| 1 ON/OFF | 5 Cook time control | 9 Cooking function display |
| 2 Light on/off | 6 Delay end control | 10 Temperature display |
| 3 Cooking function selector | 7 Set clock and timer control | 11 Cook time display |
| 4 Temperature control | 8 Instant confirm | 12 Delay end display |
| | | 13 Clock/timer display |

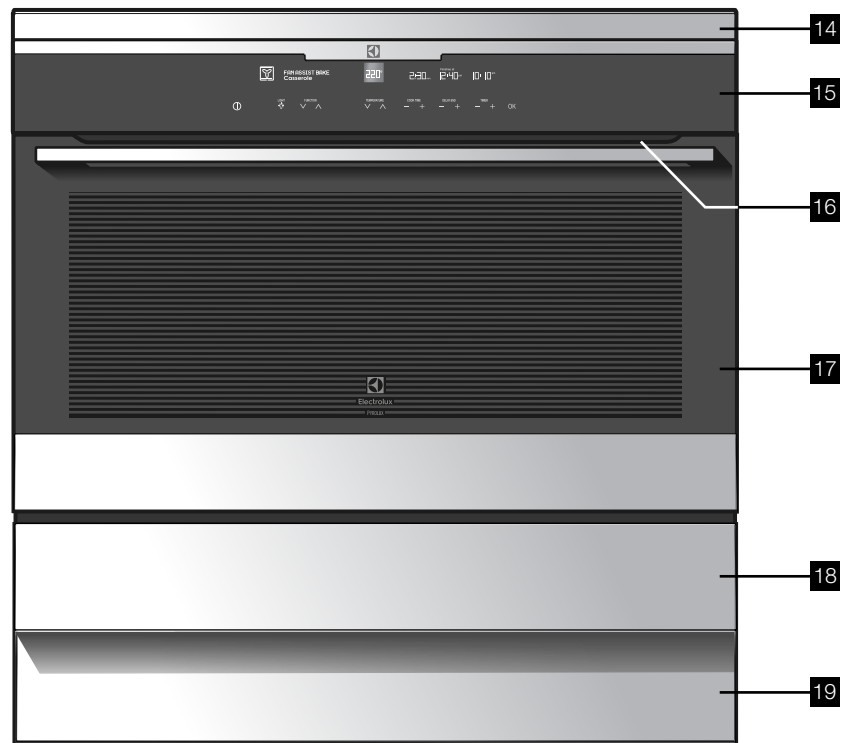

- | | | |
|--|---------------------------------|-------------------------------|
| 14 Induction hob (see page 22-29) | 16 Exhaust air outlet | 18 Storage compartment |
| 15 Control panel (see above) | 17 Quadruple glazed door | 19 Kick panel |

EFEP915SB COMPONENTS

Gas hob, multi function electric oven and programmable controller

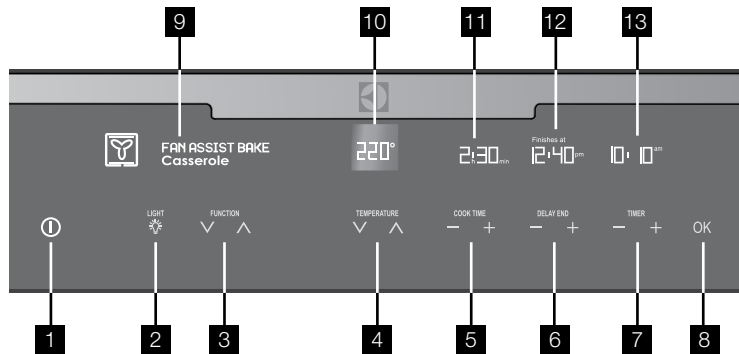

- | | | |
|------------------------------------|--------------------------------------|-----------------------------------|
| 1 ON/OFF | 5 Cook time control | 9 Cooking function display |
| 2 Light on/off | 6 Delay end control | 10 Temperature display |
| 3 Cooking function selector | 7 Set clock and timer control | 11 Cook time display |
| 4 Temperature control | 8 Instant confirm | 12 Delay end display |
| | | 13 Clock/timer display |

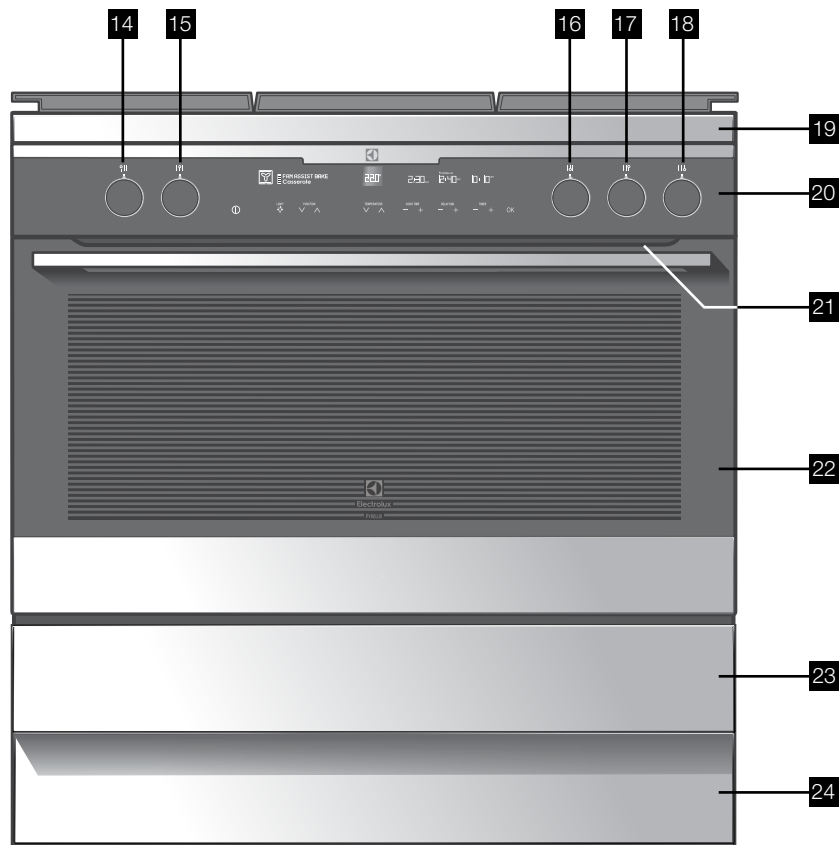

- | | | |
|-------------------------------------|-------------------------------------|---------------------------------|
| 14 Semi rapid burner control | 18 Rapid burner control | 22 Quadruple glazed door |
| 15 Auxilliary burner control | 19 Gas hob (see page 31-32) | 23 Storage door |
| 16 Wok burner control | 20 Control panel (see above) | 24 Kick panel |
| 17 Semi rapid burner control | 21 Exhaust air outlet | |

BEFORE USING THE APPLIANCE

Preparing the appliance

1. Please remove all stickers, leaflets and boxes from the door and from the floor of the oven before operation.
2. Please wipe out the oven interior prior to operation with warm soapy water and polish dry with a soft clean cloth. Do not close the oven door until the oven is completely dry.
3. Do not line the oven with foil. It will damage the enamel.

Setting the time

The time of day must be set before the appliance can operate.

After the appliance has been electrically connected “Set Clock” will illuminate under the clock display and the Hour digits will flash.

1. Use the timer + and - to set the hour portion of the current time (including AM/PM).
2. Press OK when the hours are set correctly. The Minute digits will flash.
3. Use the timer + and - to set the minutes portion of the current time.
4. Press OK when the minutes are set correctly. You can turn off the oven or it will do so after 8 seconds. Once the time has been entered, the clock advances minute by minute.

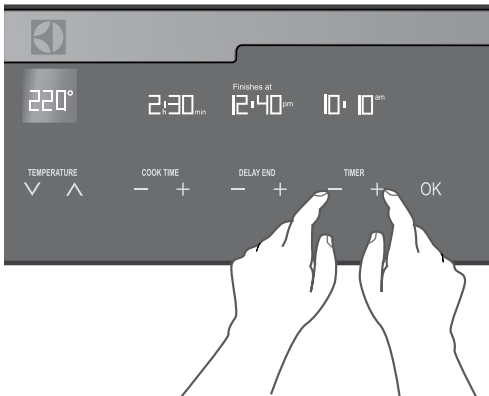

NOTE: The clock has a 12 hour display.

i IMPORTANT!

- The clock will remember the time for 24 hours without power.
- The display has 2 levels of brightness.
- Brightest illumination: whenever the oven is in use.
- Medium illumination: whenever the oven is not in use.

i IMPORTANT!

New appliances can have a smell during first use. It is recommended to ‘run in’ the oven before you cook for the first time. Operate the oven, empty, at a temperature of 180°C for approximately 1 hour. Please ensure the room is well ventilated during this process.

BEFORE USING THE APPLIANCE

Installing the side racks

1. Insert the twin pegged side into the rear access holes provided, ensuring pegs are fully inserted.
2. Then locate the front peg into the front access hole and push in firmly.

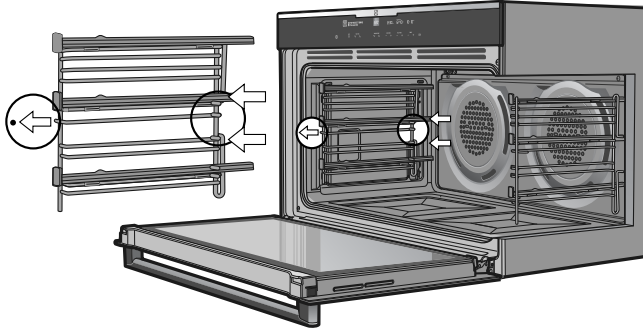

Fitting the shelves and grill dish carrier between the side rack wires

The shelves are designed so that they have maximum extension but cannot be accidentally pulled right out. The grill dish carrier is designed the same way and can slot straight into the side racks.

To fit a shelf or grill dish carrier to side racks:

1. Locate the rear edge of the shelf/carrier in between guide rails of the side rack - see diagram.
2. Ensure the same rail positions on both sides of the oven are being engaged. With the front edge raised, begin to slide the shelf into the oven.
3. Once the detents have passed the front edge of the side rack, the shelf can be pushed completely in. When fully inserted the shelf/carrier should not interfere with the closed oven door.

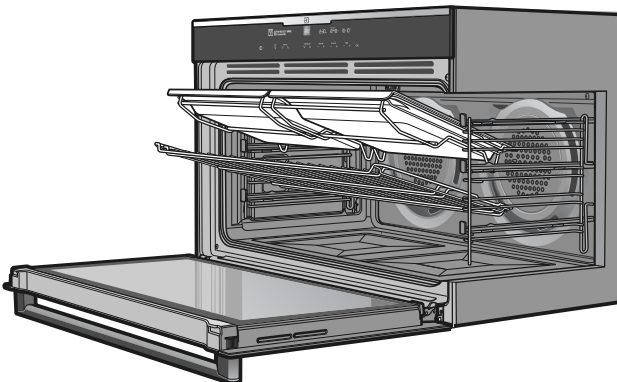

Positioning the dishes on the grill dish carrier

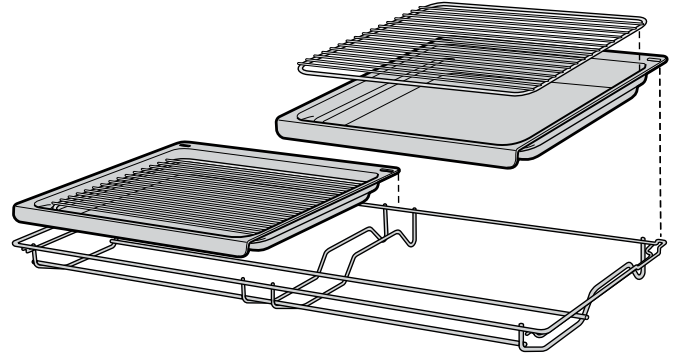

Fitting the shelves and grill dish carrier onto telescopic slides

To fit a shelf or grill dish carrier to telescopic slides:

1. With the slides fully pushed in, push the shelf/carrier along the top of the slide until it hits the back post.
2. Drop the front of the shelf/carrier ensuring it sits behind the front post of the slide (see illustration). When fully inserted the shelf/carrier should not interfere with the closed oven door.

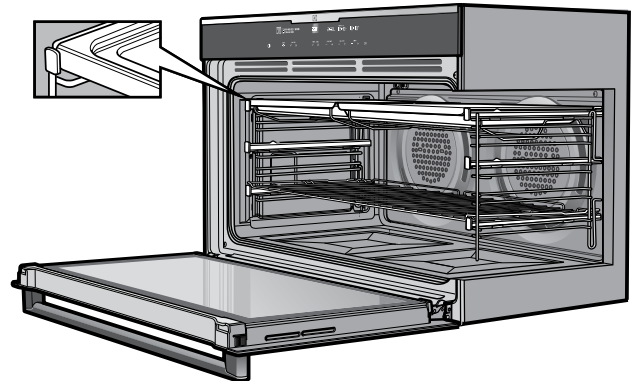

BEFORE USING THE APPLIANCE - GAS HOB MODEL

Installing the trivets

1. Position the 2 side trivets onto the hob first, ensuring the 2 corner location recesses are to the back of the hob.
2. Position the middle trivet ensuring the trivet fingers are aligned with the side trivet fingers.
3. The wok support sits on top of the trivet above the wok burner.

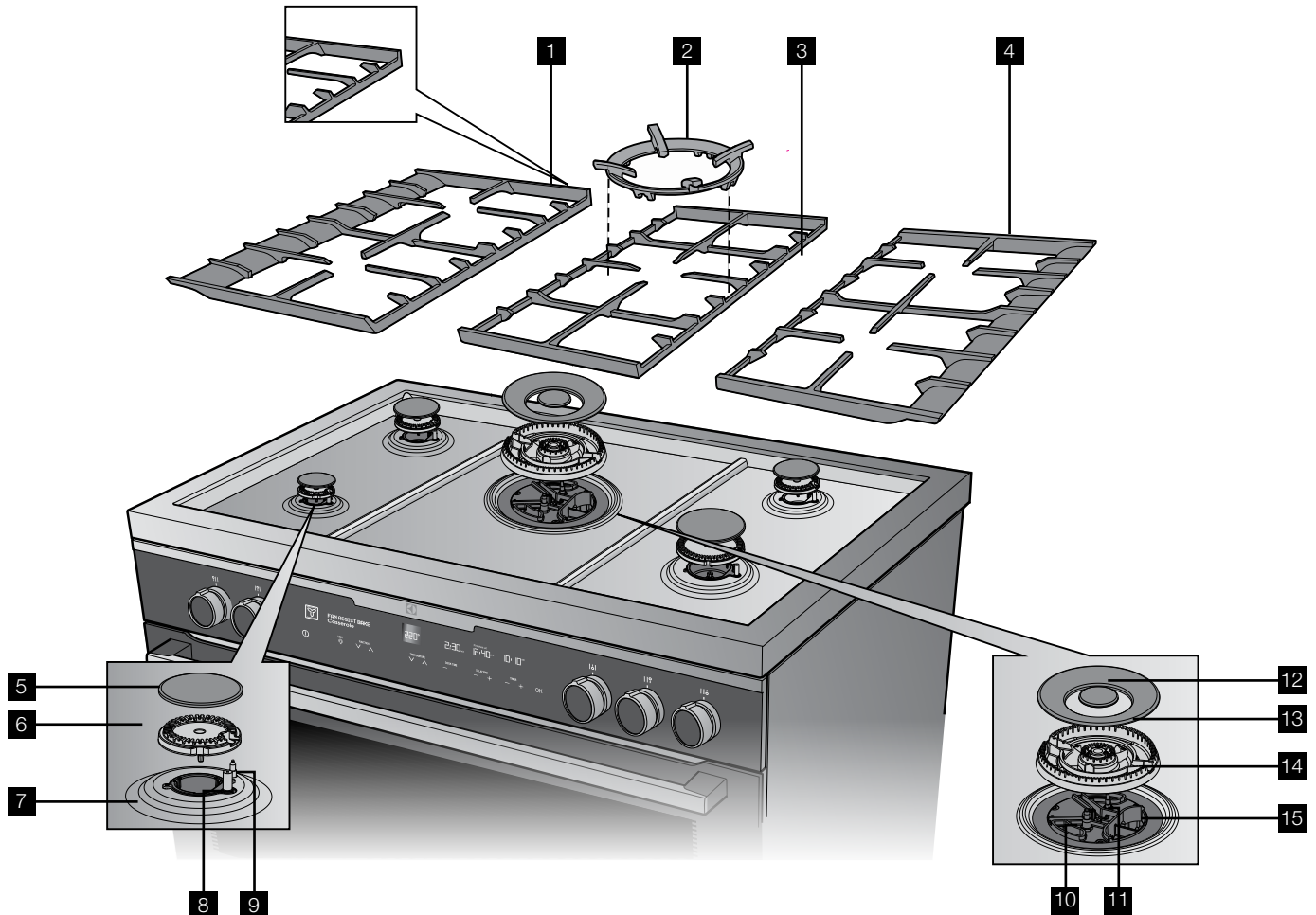

- | | | |
|--------------------------------|---|--------------------------------|
| 1 Side trivet | 7 Standard burner cup | 12 Wok burner inner cap |
| 2 Wok support | 8 Standard burner spark plug | 13 Wok burner outer cap |
| 3 Middle trivet | 9 Standard burner flame safeguard sensor | 14 Wok burner crown |
| 4 Side trivet | 10 Wok burner flame safeguard sensor | 15 Wok burner body |
| 5 Standard burner cap | 11 Wok burner spark plug | |
| 6 Standard burner crown | | |

Installing the standard burners

1. The burner crown must be fitted correctly onto the burner cup or damage will occur during operation.
2. To do this, align the outer hole and outer recess of the burner crown around the spark plug and flame safeguard sensor. Drop down ensuring the location ribs on the bottom of the crown drop into the location recesses.
3. Burner cap and burner crown must be clean and located correctly for the burner to light.

Installing the wok burners

1. The wok burner crowns must also be fitted correctly onto the wok burner cups.
2. To do this, align the sausage shaped cutouts on the burner crown with the sausage shaped cutouts on the burner body. Drop down ensuring the centre location pin of the crown has dropped into the corresponding recess in the body.
3. The 2 burner caps are simply positioned over the top of the burner crown.

NOTE: When the burners are correctly fitted they will sit level on the hob.

USING THE OVEN

Turning the oven on

- Switch on the oven by touching the ① ON/OFF symbol. The LCD control panel will come on and inform you that you need to select a cooking function.
- If you do not select a function within 20 seconds the oven will turn off.

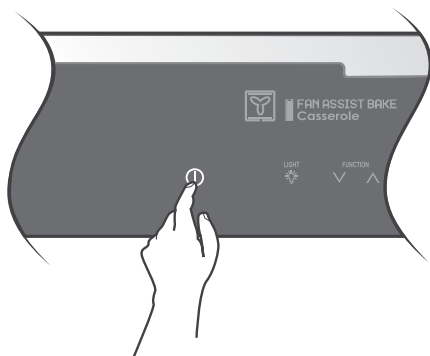

Select a cooking function

Your oven will have a selection of functions. Press the function \wedge or function \vee symbols as many times as necessary until the desired function appears.

Cooking suggestions will appear under the function name and suggested cooking temperatures will appear above the temperature selector.

If no other symbol is touched within 8 seconds the oven will switch on and begin to heat up to the displayed temperature.

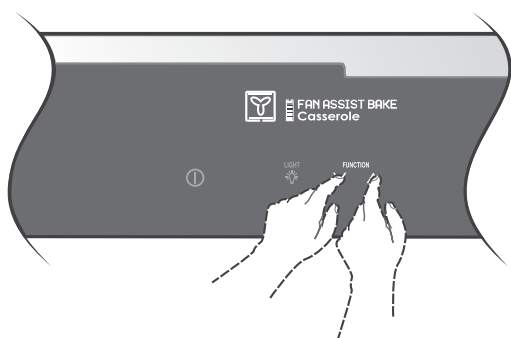

Selecting a temperature

The temperature is electronically controlled.

The temperature can be selected within the range of 30°C to 250°C and can be adjusted at any time. To set the temperature, press the temperature \wedge and temperature \vee symbols to reach the desired setting.

Press OK, or if no further changes are made within 8 seconds the oven begins to heat up to the set temperature. The current oven temperature will appear above set temperature. This will change as the oven heats up and the background colour will change from grey to red.

When the temperature is reached, "Set temperature reached" will appear, only the target temperature will be displayed.

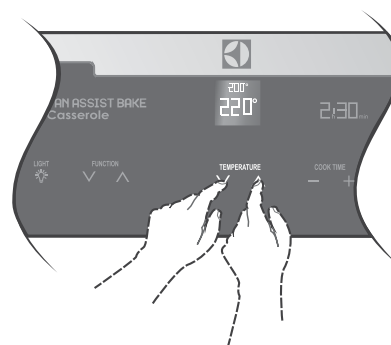

Turning the oven off

Touch the ① 'ON/OFF' symbol to switch off the oven.

i IMPORTANT!

Pre-heating

Pre-heating your oven is recommended in several cooking and grilling functions. Pre-heating your appliance allows it to reach the required temperature quickly and efficiently as well as cook your food at the correct temperature for the entire cook time.

These models are equipped with a built-in rapid heat-up that activates each time you start an oven function. During the rapid heat-up phase the heat comes from the element surrounding the fan as well as the smaller element above the food. This combination will heat up your oven 30% quicker than it would on standard "Bake". The oven will automatically revert to the set cooking function once the preset temperature is reached.

Cooling / Vent fan

The appliance is fitted with a cooling fan. This prevents the kitchen cabinet from overheating and reduces the condensation inside the oven. It will operate whenever the oven is in use and blow warm air across the top of the oven door.

NOTE: If the oven is still hot from cooking, the cooling fan will keep running to cool the oven down and will switch off by itself once cool.

Condensation

Excess condensation may fog the oven door. This may happen when cooking large quantities of food from a cold start. Minimise condensation by:

Keeping the amount of water used whilst cooking to a minimum.

Making sure the oven door is firmly closed.

Baking custard in a baking dish that is slightly smaller than the water container.

Cooking casseroles with the lid on.

NOTE: If using water in cooking, this will turn to steam and may condense outside your appliance. This is not a problem or fault with your oven.

USING THE OVEN

Cooking with the timer

Your oven is equipped with a programmable controller that can be used to turn the oven on and off automatically. The 'cook time' controls are used to automatically turn the oven off after a set amount of time. The 'Delay End' controls are used to set the time of day that you want the cooking cycle to finish at.

Setting the cook time

1. Select the desired oven function and cooking temperature.
2. Touch the cook time **+** symbol as often as necessary (or hold), until the desired cook time has been set.
3. Press 'OK' or after 8 seconds from the last time adjustment the oven will start cooking and the 'cook time' display will countdown to zero.
4. The oven will turn off and beep when the 'cook time' display reaches zero.

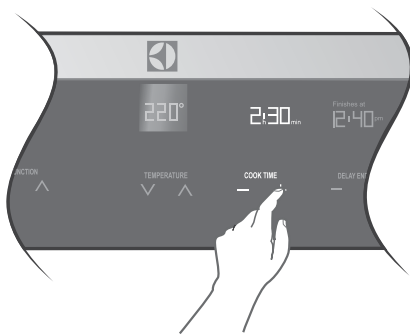

i IMPORTANT!

- When you use the 'cook time' function, the 'Finishes at' display activates and tells you what time of day the oven will turn off (based on the set cook time).
- During cooking, you can adjust the cook time with the Cook time **-** or **+** symbols.
- When the cook time has elapsed, an audible signal will sound for two minutes, the oven will switch off and COOKING FINISHED will be displayed.
- To stop the audible signal, press any of the symbols on the control panel.
- If you wish to cook a bit longer, press the cook time **+** symbol for each additional minute you require. The oven automatically reverts to the function and temperature previously programmed. This feature is available for 5 minutes after cooking has finished. After that, the oven automatically switches off.

Setting the delay end time

The delay end function can be used to switch the oven on and off at a specific time during the day.

1. Check the clock displays the correct time of day.
2. Select the desired oven function and cooking temperature.
3. Set the required cook time.
4. Press the 'delay end' symbol **+** to move the end time.
5. Touch 'OK' or after 8 seconds from the last time adjustment the SET icon will light and your oven is now programmed. The oven will start its cooking cycle to finish at the set 'end time'.
6. When the oven has finished cooking, cook time can be extended or the beeper turned off just as in 'cook time' mode.

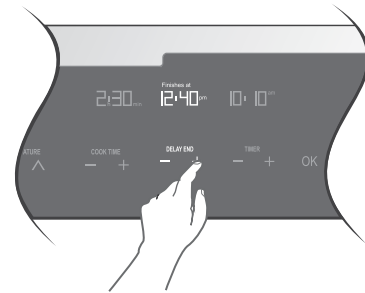

7. Touch the 'delay end' **+** symbol to move the end time forward.
8. Touch 'OK' or after 8 seconds from the last time adjustment the SET icon will light and the oven is now programmed.

The oven will commence its cooking cycle to finish at the set 'end time'.

i IMPORTANT!

- 30 seconds after a cooking function has started, it is no longer possible to delay the start time.
- In order to delay a cooking function that has already started, the oven needs to be switched off then switched on again and re-programmed.
- Even though the heating element turns off, the oven will still retain substantial heat. This will continue to cook food until it is removed or the oven cools down. If you do not plan on being present when the oven turns off, you should take this extra heating time into account.

USING THE OVEN

Timers

The appliance has two timers which can be used one at a time. The count up timer can be used to measure a period of time. The count down timer beeps at the end of a preset time.

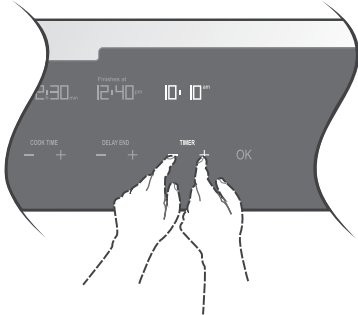

Setting the count up timer

The timer can be used independently of the oven for measuring a count up period. There is no alert provided with this timer.

1. Touch either 'timer' **+** or **-**.
2. 00min will be displayed along with a bell and the up arrow will flash.
3. To begin the count up timer press OK or wait 8 seconds.
4. To reset the count up timer, press 'timer' **-** once to show 00min. Press OK to restart or wait 8 seconds.
5. To cancel the count up timer press 'timer' **-** twice.

Setting the count down timer

The timer can be used independently of the oven for setting a count down period. When the period of time has elapsed, an audible signal sounds.

1. Touch either 'timer' **+** or **-**.
2. 00min will be displayed along with a bell and the up arrow will flash.
3. Touch the 'timer' **+** to set the countdown period.
4. The timer bell icon  will flash.
5. To begin the count down timer press OK or wait 8 seconds. When the timer starts, the bell will stop flashing and the timer will begin to count down.
6. When the set time has elapsed, an audible signal will sound for 2 minutes. The time indication '00min' and the timer bell will flash on the display.
7. To stop the signal, touch either of the 'timer' **+** or **-** symbols.
8. To cancel the count down timer, continue to touch 'timer' **-** until zero is reached.

Adjusting the clock

1. Switch on the oven by touching  'ON/OFF' symbol.
2. Select 'SETTINGS' from the function list and touch OK.
3. Select 'SET CLOCK' from the list and touch OK.
4. 'Set Clock' will illuminate under the clock display.
5. Use the timer **+** and **-** to set the hour portion of the current time (including AM/PM).
6. Touch 'OK' when the hours are set correctly.
7. Use the timer **+** and **-** to set the minutes portion of the current time.
8. Touch 'OK' when the minutes are set correctly. TIME SAVED will be displayed and then the function display will revert to the 'set clock' menu. Turn off the oven or it will do so after 8 seconds.

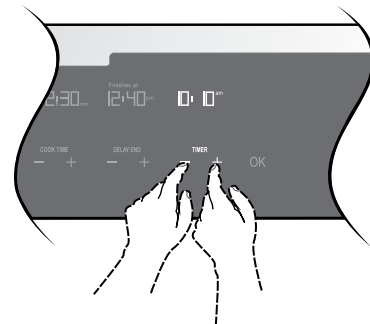

Additional functionality

Light on/off

Turn the oven lamps off and on when in any cooking mode by simply touching the symbol .

USING THE OVEN

Activating the child-proof lock

When the child lock is engaged, the oven cannot be switched on.

1. Switch on the oven by touching the ① 'ON/OFF' symbol.
2. Select 'SETTINGS' from the function list and touch 'OK'.
3. Select 'ACTIVATE LOCK' from the list and touch 'OK'.
4. The words LOCKED are displayed, a single beep will sound to confirm the operation. The child lock is now engaged.

De-activating the child lock

1. Touch any symbol on the control panel (including the ① 'ON/OFF' symbol). 'Locked' will appear on the display.
2. Touch any symbol again. The display will instruct you to touch both 'cook time' symbols for 2 seconds.
3. Hold until a beep sounds. The child lock is now released and the oven is ready to use.

Other settings

The 'Settings' function gives the opportunity to change oven functionality.

1. Switch on the oven by touching the ① 'ON/OFF' symbol.
2. Select 'SETTINGS' from the function list and touch OK.
3. Select 'SET CLOCK' to change the time of day.
4. Select 'TIME OF DAY' to have the time permanently displayed or not.
5. Select 'BUZZER VOLUME' to adjust the 'beep on touch' and alarm loudness.
6. Select 'KEY TONE' to turn the 'beep on touch' on or off.
7. Select 'SCREEN BRIGHTNESS' to adjust the brightness of the display.
8. Select 'SCREEN CONTRAST' to adjust the contrast of the display.
9. Select 'TEMPERATURE UNITS' to change between Celsius and Fahrenheit units.
10. Select 'ACTIVATE LOCK' to turn child lock on.
11. Touch 'OK' to go into each selection to change its settings.

Safety cut-out features

The oven automatically switches itself off if the temperature is not adjusted or the appliance is left operating after a period of time. The oven switches itself off after:

- 12.5 hours when the temperature is set between 30°C and 120°C.
- 8.5 hours when the temperature is set between 120°C and 200°C.
- 5.5 hours when the temperature is set between 200°C and 250°C.

Demo mode

This mode is intended to be used in retail shops to demonstrate the oven functionality without any power consumption except to the oven lights.

The following instructions demonstrate how to enter and exit 'DEMO' mode.

1. Ensure the oven is off by touching the ① 'ON/OFF' symbol.
2. Touch and hold the ① 'ON/OFF' symbol until the display turns ON then OFF. Immediately after, touch both the cooktime symbols simultaneously. Hold until a triple beep sounds.

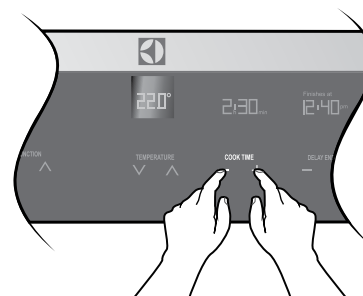









Condensation

Excess condensation may fog the oven door. This may happen when cooking large quantities of food from a cold start. Minimise condensation by:





- Keeping the amount of water used whilst cooking to a minimum.
- Making sure the oven door is firmly closed.
- Baking custard in a baking dish that is slightly smaller than the water container.
- Cooking casseroles with the lid on.

NOTE: If using water in cooking, this will turn to steam and condense outside your appliance. This is not a problem or fault with your oven.

OVEN COOKING FUNCTIONS

Symbol	Function Description
Fan cook 	<p>Heat comes from the element surrounding the fan. This fan circulates the hot air around the oven cavity so that you can put your food in different places in the oven and still cook them at the same time. You can use the 'Fan Cooking' function for multi-shelf cooking, reheating cooked foods, pastries and complete oven meals. It will cook at a lower temperature and be faster than baking. Please note that some variation in browning is normal.</p>
Traditional bake 	<p>Heat comes from two elements, one above and one below the food. The bottom element is a clean heat element and is below the floor of the oven. Both elements are controlled by the thermostat and will turn on and off to maintain set temperature. You can use the 'Traditional Bake' function for single shelf cooking, single trays of biscuits, scones, muffins, cakes, slices, casseroles, baked puddings, roasts and delicate egg dishes. This is a general function that can be used for most cooking.</p>
Fan assist bake 	<p>Heat comes from two elements, one above and one below the food. The fan circulates the hot air around the oven cavity so that you can put the food in different places in the oven and still cook them at the same time. You should only use a maximum of two shelves with 'Fan Assist Bake'. Do not use the bottom shelf. If the two shelves are used, food on the shelf in the higher position will cook first and should then be removed to allow the food on the lower shelf to finish cooking.</p>
Roast 	<p>This function starts at a higher temperature to seal the meat. The oven will then automatically reduce to the selected temperature to cook the meat for as long as desired. For example, if you use the default 200°C the 'Roast' cycle will start at 240°C and then lower to 200°C.</p>
Pastry 	<p>The 'Pastry' function is specially designed for food that require extra browning such as the bases of pastries and pies. Heat comes from the element below the food. If you choose the default setting, the oven will heat up to 230°C in order to brown the food. You should then lower the temperature as required. Cook in the lower half of the oven when you are using only one shelf.</p>
Pizza 	<p>'Pizza' is a combination of 'Pastry' and 'Fan Assist Bake' and offers you the combined benefits of both functions. Heat switches between the element surrounding the fan and the clean heat element below the oven floor. The 'Pizza' function is ideal for foods that require cooking and browning on the base. It is for foods such as pizzas, quiches, meat pies and fruit pies. Simply place the food in the middle of the oven and set the desired temperature.</p>
Cook from frozen 	<p>The 'Cook from Frozen' function is ideal for cooking frozen pre-cooked foods such as savoury pastries, pizzas, mini meals (TV dinners), meat pies and fruit pies. Heat comes from the element surrounding the fan as well as a smaller element above the food. Simply place the food in the oven straight from the freezer and heat. Cook in the upper half of the oven for best results.</p>
Full grill 	<p>'Full Grill' directs radiant heat from two powerful upper elements onto the food. You can use 'Full Grill' function for tender cuts of meat, steak, chops, sausages, fish, cheese toasties and other quick cooking foods.</p> <p>Grill with the oven door closed.</p> <p>'Full Grill' allows you to take full advantage of the large grill dish area and will cook faster than the 'Half Grill' function. For best results it is recommended to preheat your grill for three minutes. This will help seal in the natural juices of steak, chops etc for a better flavour.</p> <p>Full Grill has 2 temperature settings, 'LO' and 'HI'.</p>

OVEN COOKING FUNCTIONS CONTINUED

Left grill	 <p>The 'Left Grill' directs radiant heat from only one of the powerful upper elements onto the food. The 'Left Grill' function is used instead of 'Full Grill' when only half the amount of grill area is needed. Left Grill has 2 temperature settings, 'LO' and 'HI'.</p> <p>Grill with the oven door closed.</p>
Fan grill	 <p>'Fan Grill' offers you the benefits of both fan assist bake and traditional grill functions. The grill element turns on and off to maintain set temperature while the fan circulates the heated oven air.</p> <p>Grill with the oven door closed.</p> <p>You can use 'Fan Grill' for large cuts of meat, which gives you a result similar to 'roisserie' cooked meat. Put your food on a shelf in the second lowest shelf position. Put the grill dish on the lowest shelf position to catch any spills. When using 'Fan Grill' it is not necessary to turn the food over during the cooking cycle. Set temperature to 180°C.</p>
Keep warm	 <p>The 'Keep Warm' function is a low temperature oven function designed to keep your food at a perfect eating temperature without cooking it further. Heat comes from the smaller elements above the food and is circulated by the fan. Use 'Keep Warm' to keep your food warm while you prepare the rest of the meal or afterwards while you wait for the late arrival.</p> <p>Note: After cooking, the oven retains enough heat to continue to cook food even if the elements are turned off. The 'Keep Warm' function recognises this by giving you a warning message. If this happens the function will not start.</p>
Defrost	 <p>The 'Defrost' function uses low temperature air that is circulated by the fan. You can defrost (thaw) your food before you cook it. You can also use 'Defrost' to raise your yeast dough and to dry fruit, vegetables and herbs. The 'Defrost' function does not have a suggested temperature but uses the ambient heat in the oven cavity.</p>
Pyro	 <p>The 'pyrolytic cleaning' function cleans by burning off the spatters and accumulated dirt and grease from the oven liner, at high temperature. This process produces ash which can be wiped out of the oven cavity.</p>

Oven shelf location

Your oven has 6 positions for mounting the shelves or grill dish carrier.

These are numbered from 1 (the lowest shelf position) to 6 (the highest shelf position). See diagram.

To give maximum space above and below the shelves, load them in this way:

- When cooking with 1 shelf, use position 1 or 3 .
- When cooking with 2 shelves, use position 1 and 3.
- When grilling use position 4, 5 or 6.

NOTE: Use the oven efficiently, by cooking many trays of food at the same time e.g. 2 trays of scones, small cakes or sausage rolls.

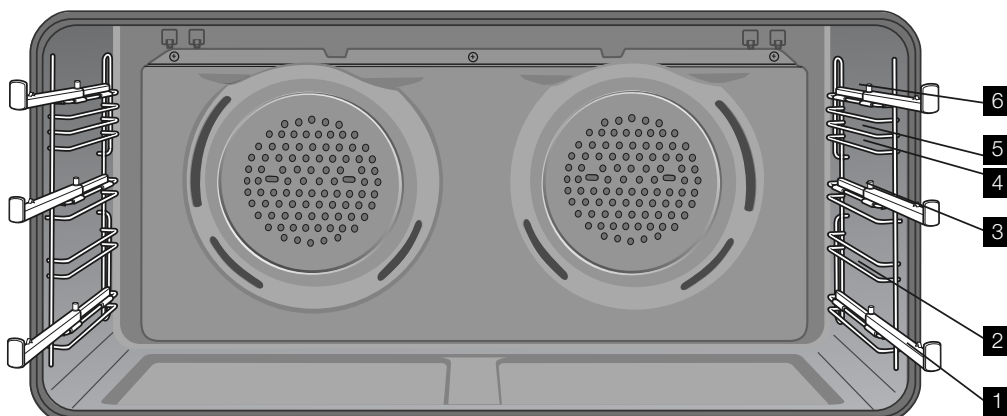

OVEN BAKING GUIDE

Choosing the best oven settings

The following table is intended as a guide and experience may show some variation in cooking times necessary to meet individual requirements. We recommend that you preheat your oven for 30 minutes.

Modes without Oven Fan

Food		Temperature °C	Oven shelf position*	Time in minutes
Scones	Plain or fruit	220	2 or 3	10 – 15
Biscuits	Rolled	170	3	13 – 18
	Spooned	190	3	13 – 18
	Shortbread biscuits	160	3	30 – 35
Meringues	Hard - individual	110	3	90
	Soft - individual	180	3	15 – 20
	Pavlova - 6 egg	110	3	75
Cakes	Cupcakes	190	2 or 3	15 – 20
	Sponge - 4 egg	180	2 or 3	20 – 30
	Shallow butter cake	180	3	25 – 30
Pastry – short crust	Cornish pasties	200	3	40 – 45
	Custard tart	200/180	3	Pastry 8/200 Whole tart 10/200 & 20/180
Pastry – choux	Cream puffs	210	3	25 – 30
Yeast goods	Bread	210	3	25 – 30

Modes with Oven Fan

Food		Temperature °C	Oven shelf position*		Time in minutes
			single shelf	multi shelf	
Scones	Plain or fruit	210	2 or 3	1 & 3	10 – 15
Biscuits	Rolled	150	2 or 3	1 & 3	13 – 18
	Spooned	180	2 or 3	1 & 3	13 – 18
	Shortbread	150	2 or 3	1 & 3	13 – 18
Meringues	Hard – individual	100	2 or 3	1 & 3	90
	Soft – individual	165	2 or 3	1 & 3	15 – 20
	Pavlova – 6 egg	100	2 or 3	1 & 3	75
Cakes	Cupcakes	180	2 or 3	1 & 3	15 – 20
	Sponge – 4 egg	170	2 or 3	1 & 3	20 – 30
	Shallow butter cake	170	2 or 3	1 & 3	25 – 30
	Rich fruit cake	170	2 or 3	1 & 3	60
Pastry – short crust	Cornish pasties	180	2 or 3	1 & 3	40 – 45
	Custard tart	190/170	2 or 3	1 & 3	20 – 30
	Whole tart				Pastry 8/190 Whole tart 10/190 & 20/170
Pastry – choux	Cream puffs	200	2 or 3	1 & 3	25 – 30
Yeast goods	Bread	200	3	1 & 3	25 – 30

* Counting from the bottom shelf up.

OVEN COOKING GUIDE

Roasting meat

- Place the meat in the oven and set the temperature between 180°C and 200°C. (It is recommended to wrap your meats in an oven roasting bag or foil to prevent fats and oils from splattering, making it easier to clean your oven.)
- Use the grill/oven dish and grill insert. Place the meat on the insert.
- Do not pierce the meat, as this will allow juices to escape.
- When the meat is cooked, take the roast out of the oven, wrap in aluminium foil and leave to stand for about 10 minutes. This will help retain the juices when the meat is carved. The table shows temperatures and cooking times for different kinds of meat. These may vary depending on the thickness or bone content of the meat.

Meat	Recommended temperature		Minutes per kilogram
Beef	180°C - 200°C	Rare	35 - 40
		Medium	45 - 50
		Well done	55 - 60
Lamb	180°C - 200°C	Medium	40
		Well done	60
Veal	180°C - 200°C	Well done	60
Pork	180°C - 200°C	Well done	60

Roasting poultry and fish

- Place the poultry or fish in an oven set at a moderate temperature of 180°C.
- Place a layer of foil over the fish for about three quarters of the cooking time.

The table shows temperatures and cooking times for different kinds of fish and poultry. These may vary depending on the thickness or bone content of the meat.

Poultry & Fish	Recommended temperature	Minutes per kilogram
Chicken	180°C - 200°C	45 - 50
Duck	180°C - 200°C	60 - 70
Turkey	180°C - 200°C	40 - 45
		(>10kg)
		35 - 40
		(<10kg)
Fish	180°C - 200°C	20

Grilling Guide



WARNING!

NOTE: Always clean the grill/oven dish after every use. Excessive fat build-up may cause a fire.

Grilling is conducted with the oven door closed

As a method of cooking, grilling can be used to:

- Enhance the flavours of vegetables, fish, poultry and meat.
- Seal the surface of the food and retain the natural juices.

This table shows how to grill different types of meat:

Beef	Tenderloin, rump, sirloin. Brush with oil or melted butter, especially if the meat is very lean.
Lamb	Loin chops, short loin chops, chump chops, and forequarter chops. Remove skin or cut at intervals to stop curling. Brush with oil or melted butter.
Sausages	Prick sausages to stop skin from bursting.
Poultry	Divide into serving pieces. Brush with oil.
Fish	Brush with oil or melted butter and lemon juice.
Bacon	Remove rind. Grill flat.

Guide to better grilling

Steak	15 - 20 minutes
Chops	20 - 30 minutes
Fish	8 - 10 minutes
Bacon	4 - 5 minutes

No definite times can be given for grilling because this depends on your own tastes and the size of the food. These times should only be used as a guide and remember to turn the food over halfway through the cooking process.

For better grilling results, follow these easy instructions:

- Preheat grill for at least 5 minutes.
- Choose only prime cuts of meat or fish. If the cut is less than 5mm thick it will dry out. If the cut is more than 40mm thick, the outside may burn whilst the inside remains raw.
- Do not place aluminium foil under the food as this prevents fats and oils from draining away, which could result in a fire.
- Baste the food during cooking with butter, olive oil or marinade. Grilled food is better if marinated before cooking.
- Use tongs to turn food as a fork pierces the surface and will let juices escape.

Fan Grill

The "Fan Grill" assists the grilling process by circulating the heat evenly around the food. The recommended temperature setting is 180°C for all fan grilling functions.

- Place the grill dish on the bottom rack.
- Place meat/poultry on an oven shelf above the grill dish.
- Wipe off any oil or fat which spatters while the oven is still warm.

DEALING WITH COOKING PROBLEMS

Problem	Causes	Remedies
Uneven cooking:	<p>Incorrect shelf position.</p> <p>Oven tray too large.</p> <p>Trays not centralised.</p> <p>Air flow in oven uneven.</p> <p>Grill dish affecting thermostat.</p>	<p>Select shelf that puts food in the centre of the oven.</p> <p>Experiment with other trays or dishes.</p> <p>Centre trays.</p> <p>Rotate food during cooking.</p> <p>Remove grill dish from oven on bake modes.</p>
Baked products too brown on top:	<p>Oven not preheated.</p> <p>Baking tins too large for the recipe.</p> <p>Baking tins not evenly spaced.</p> <p>Products not evenly sized or spaced on trays.</p> <p>Baking temperature too high.</p>	<p>Preheat the oven.</p> <p>Use correct size tins.</p> <p>Stagger baking tins at least 3cm between tins and the oven walls.</p> <p>Make into same size and shape, and spread evenly over trays.</p> <p>Lower the temperature.</p>
Baked products too brown on bottom:	<p>Baking tins too large for the recipe.</p> <p>Baking tins are dark metal or glass.</p> <p>Food too low in the oven.</p> <p>Oven door opened too frequently during baking.</p> <p>Baking temperature too high.</p> <p>Grill dish affecting thermostat.</p>	<p>Use correct size tins.</p> <p>Change to shiny, light tins or lower the temperature by 10°C.</p> <p>Cook one shelf higher.</p> <p>Don't open the oven door until at least half the cooking time has passed.</p> <p>Lower the temperature.</p> <p>Remove grill dish from oven on bake modes.</p>
Cakes have a cracked, thick crust:	<p>Baking temperature too high.</p> <p>Food too high in oven.</p> <p>Cake batter over mixed.</p> <p>Pan too deep.</p> <p>Baking pans dark.</p>	<p>Lower the temperature.</p> <p>Cook one shelf lower.</p> <p>Mix just long enough to combine ingredients.</p> <p>Check size of pan and use recommended size.</p> <p>Change to shiny pans.</p>
Baked products are pale, flat and undercooked:	<p>Baking temperature too low.</p> <p>Food too low in oven.</p> <p>Baking time too short.</p> <p>Incorrect tin size.</p>	<p>Raise the temperature.</p> <p>Cook one shelf higher.</p> <p>Increase cooking time.</p> <p>Use correct size tin.</p>
Cakes fallen in the centre:	<p>Baking temperature too low.</p> <p>Baking time too short.</p> <p>Proportions of ingredients incorrect in the recipe.</p> <p>Opening door too early in baking.</p>	<p>Raise the temperature.</p> <p>Increase cooking time.</p> <p>Check recipe.</p> <p>Do not open the door until the last quarter of cooking time.</p>
Roast meat & potatoes not browning in fan oven:	<p>Poor hot air circulation.</p> <p>Grill dish affecting thermostat.</p>	<p>Elevate food onto a rack to allow air circulation.</p> <p>Remove grill dish from oven on bake modes.</p>
Juices running out of meat:		Do not pierce meat with fork, turn with tongs.
Grilled meats overcooked on outside & raw in the centre:		Grill at lower insert position.
Grilled chops & steaks curling:		Cut into fat every 2cm.

OVEN COOKING TIPS

- For best baking results preheat oven for 30 minutes.
- Select the correct shelf location for food being cooked.
- One of the grill trays can be used in the oven as a baking dish.
- Make sure dishes will fit into the oven before you switch it on.
- Keep edges of baking dishes at least 40mm from the side of the oven. This allows free circulation of heat and ensures even cooking.
- Do not open the oven door more than necessary.
- Do not place foods with a lot of liquid into the oven with other foods. This will cause food to steam and not brown.
- After the oven is turned off it retains the heat for some time. Use this heat to finish custards or to dry bread.
- Do not use a lot of cooking oil when roasting. This will prevent splattering oil on the sides of the oven and the oven door. Polyunsaturated fats can leave residue which is very difficult to remove.
- When cooking foods which require a high heat from below (e.g. tarts), place the cooking dish on a scone tray in the desired shelf position.
- For sponges and cakes use aluminium, bright finished or non-stick utensils.
- Remove unnecessary trays or dishes when roasting or baking.

Get to know your new oven with this simple test cake

Although we strive for a perfect performing oven, it's possible that there will be some variation in colour when baking. Therefore, we suggest this simple, easy and delicious to make Simple Test Cake, it can help you understand your new oven. All ovens do sometimes have hot or cold spots, therefore it is important to judge with your eye as you may require to rotate during baking.

Simple Test Cake

125g butter, softened to room temperature

1 cup caster sugar

1 teaspoon pure vanilla essence

4 large eggs

2 cups self-raising flour

Pinch of salt

4 tablespoons (80ml) full-cream milk

Method:

1. Butter base and sides of two, 20cm straight-sided round or square cake pans. Then line the base with grease proof or baking paper.
2. Preheat oven to moderate '180°C' (170°C fan forced) and ensure oven shelf is in the centre position of oven.
3. Cream softened butter and sugar until light in colour.
4. Add vanilla essence.
5. Then eggs one at a time, beating well after each addition.
6. Sift flour and salt into the mixture and beat until well combined.
7. Add milk and beat or stir to combine.
8. Spoon mixture equally between prepared cake pans.
9. Bake in preheated oven, middle shelf for about 25 to 35 minutes or until when tested with a fine cake skewer it comes out clean, or the edges of the cakes have come away slightly from the sides of the cake pans.
10. Remove from oven to wire cake rack and rest for 5 minutes before removing from cake pans. Cool completely.

To serve: Sandwich together with your favourite jam or conserve, and dust top with pure icing sugar.

NOTE: If desired, substitute butter for either margarine or olive oil spread. Recipe is based on the Australian standard metric 250ml cup and 20ml tablespoon sets.

OVEN TROUBLESHOOTING

If there is a problem with the appliance, please:

- Check the points listed below before calling for service. It may be possible to avoid a call by fixing the problem yourself – and so continue cooking.

Problem	Possible cause	Remedy
Oven or grill not working	Time of day is not set	Set time of day
	Power is not turned on	Switch on electricity
	Controls are incorrectly set	Reset controls
	Oven is in 'Demo' mode	Exit Demo mode (page 14)
	Household fuse has blown or circuit breaker tripped	Check fuses or circuit breakers
Oven light not working	Child-proof oven lock is activated	Deactivate child lock (page 14)
	Light may be turned off at control panel	Turn light on (page 13)
	Lamp blown or loose socket	Replace or tighten lamp (page 36)
Oven not heating enough	Household fuse has blown	Check fuses
	Foil trays on bottom of oven	Remove foil trays
	A timer function is activated	Refer timer functions (12-13)
Clock flashing on display	Household fuse has blown or circuit breaker tripped	Check fuses or circuit breakers
	Power interruption	Reset the time (page 8)
Unit smoking when first used	Protective oils being removed	Turn grill on high for 30mins and then oven on 200° for 1 hour
Functions and temperature appear on display but oven does not work	Oven is in 'Demo' mode	Exit Demo mode (page 14)
When the door is open the fan stops	This is normal operation	
When a non fan mode is selected the oven fan starts	The fan is used to help the oven get to the selected temperature as quickly as possible	
The light stays on when the door is closed	An oven function has been selected	
	The light has been turned on at the control panel	Turn light off (page 13)
The light does not activate when the door is opened	Lamp blown or loose socket	Replace or tighten lamp

Further Information

When you need information, service or replacement parts or have a warranty enquiry, please contact the Customer Care Centre:

- Australia - 1300 363 640, 8.00am-5.00pm EST Monday to Friday
- New Zealand - 0800 436 245, 8.00am-5.00pm EST Monday to Friday

Please have the following information ready: Model, Model Number & Serial Number. This is shown on the data plate which is visible when the oven door is open.

USING THE INDUCTION HOB

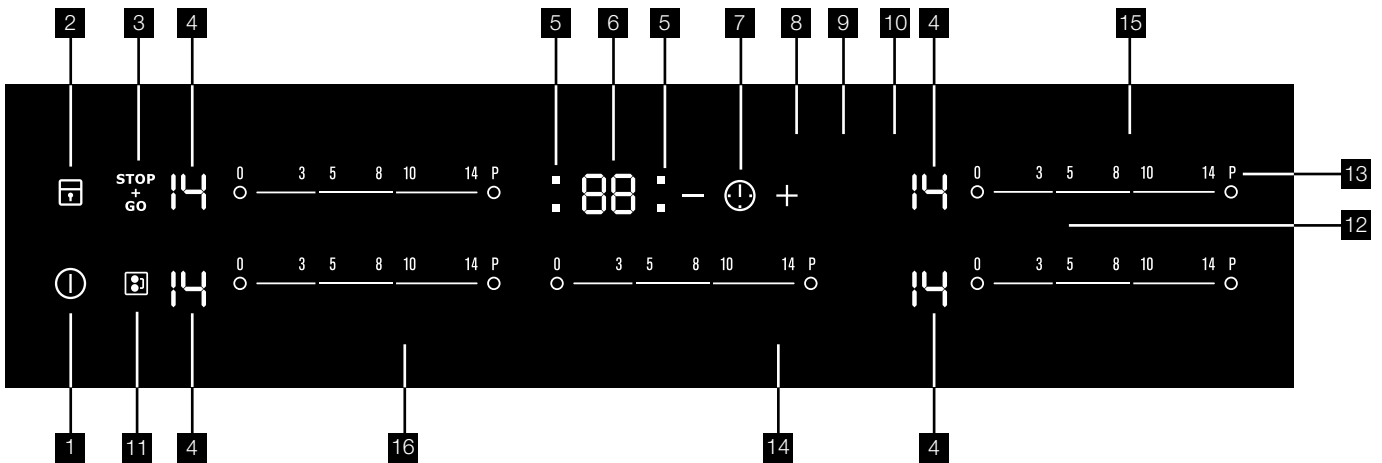
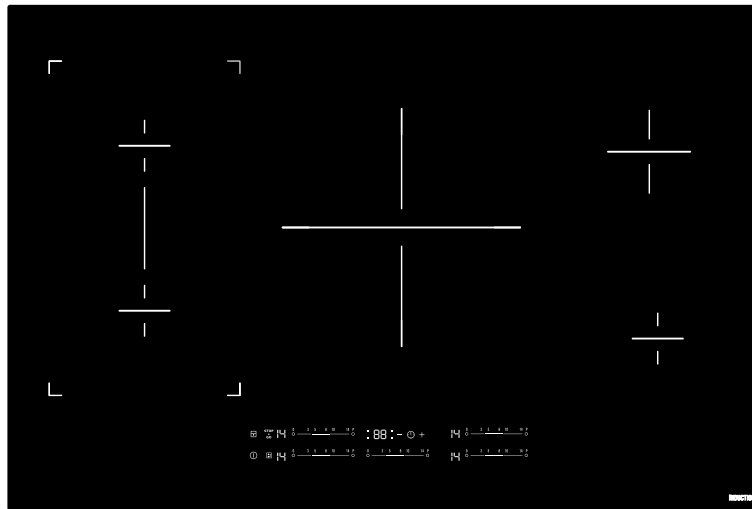

Use the sensor fields to operate the appliance. The displays, indicators and sounds tell which functions operate.

Sensor field	Function
1 ⓘ	Activates and deactivates the hob.
2 🔒	Locks and unlocks the control panel.
3 STOP + GO	Activates and deactivates the STOP + GO function.
4 Heat setting display	Indicates the selected heat setting.
5 Timer indicators of cooking zones	Indicates which of the cooking zones you have set the timer for.
6 Timer display	Indicates the time in minutes.
7 ⌚	Indicates the Count Up timer is operating (1 to 59 minutes).
8 🔔	Indicates the Count Down Timer or the Minute Minder is operating (1 to 99 minutes).

USING THE INDUCTION HOB

	Sensor field	Function
9		Indicates which cooking zone.
10		Indicates that the cookware is incorrect, the diameter of the bottom of the cookware is too small or there is no cookware on the cooking zone.
11		Activates and deactivates the Bridge function.
12	P	Activates and deactivates the Power function.
13	+ / -	Increases or decreases the time.
14		Sets the cooking zone for the Timer function.
15		Sets the Timer functions.
16	Control bar	Sets the heat setting.

	Display	Function
5		Indicates the cooking zone is deactivated.
5		Indicates the cooking zone is operated.
5		Indicates the ^{STOP} function is operated.
5		Indicates the Automatic Heat Up function is operated.
5		Indicates the Power function is operated.
5		Indicates there is a malfunction (refer to malfunction list on page 29).
5		Indicates how much residual heat is left on a zone.
5		Indicates the Child Safety Lock is operated.
5		Indicates the use of incorrect cookware, too small or no cookware on the cooking zone.
5		Indicates the Automatic Switch Off function has operated.



WARNING!

Risk of burns from residual heat!

The residual heat display indicates how much heat is left on the ceramic glass when the zone is deactivated. Use this display to help avoid the risk of burns.







USING THE INDUCTION HOB

Activation and deactivation

Touch  for 1 second to activate or deactivate the appliance.

Automatic switch off

THE APPLIANCE WILL AUTOMATICALLY SWITCH OFF IF:

- All cooking zones are deactivated (.
- You do not set the heat setting after you activate the appliance.
- You spill something or put something on the control panel for more than 10 seconds (a pan, a cloth, etc). An acoustic signal will sound and the appliance will switch off. Remove the object or clean the control panel.
- The appliance becomes too hot (e.g. when a saucepan boils dry). Before you use the appliance again, wait for the cooking zone to cool down.
- You use incorrect cookware. The symbol  will come on and the cooking zone will deactivate automatically after 2 minutes.
- A cooking zone is on for an extreme length of time. The symbol  will show and the appliance will switch off. See below.
- The length of time that various settings can run for before automatic switch off occurs are shown below:
 -  - 6 hours
 -  - 5 hours
 -  - 4 hours
 -  - 1.5 hours

The heat setting

To adjust the heat setting, place your finger over the heat bar graphic and slide across. The display will show the adjusted heat setting.

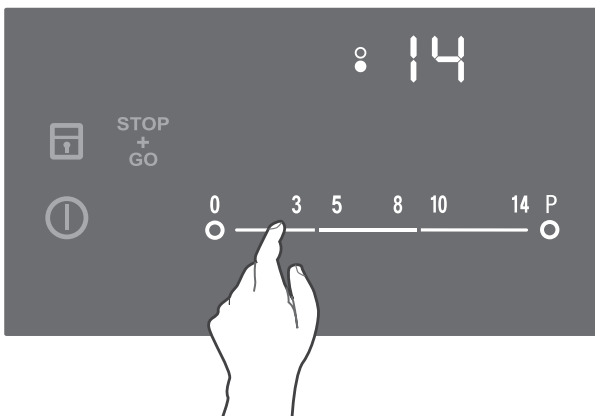



NOTE: When you use cookware larger than 180mm the manufacturer recommends that you put it on the rear cooking zones.

Bridge function

The Bridge function connects two cooking zones together and then operates them as one. You can use this function for cookware larger than 260mm.

First set the heat setting for one of the cooking zones.



To activate the Bridge function touch . The indicator will then come on. To set or change the heat setting, touch either one of the control sensors.

To deactivate the Bridge function touch . The indicator will go off. The cooking zones will then operate independently.

Fast heat up function

You can get a required heat setting in a shorter time if you activate the Fast Heat Up function. This will run the cooking zone at maximum until the required heat setting is reached.

To start the Fast Heat Up function for a cooking zone:

1. Touch the power function sensor **P** ( will come on).
2. Immediately touch your required heat setting. After 3 seconds  comes on in the display.
3. The zone will heat at maximum until your required heat setting is reached. The display will then change from  back to the required heat setting.
4. To stop the Fast Heat Up function change the heat setting.

USING THE INDUCTION HOB

Power management

Power management divides the power between the front and rear zones for each of the 2 outer modules. See illustration below:

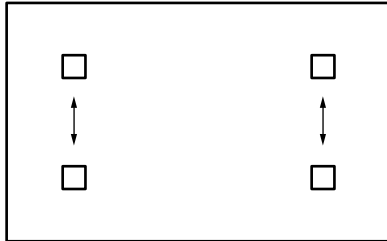

This allows either the front or rear zone to draw power from the other, if maximum power is required.









The timer

The count down timer

Use the count down timer to set how long you want a cooking zone to operate.

i IMPORTANT!

The selection of the timer function is only possible if the zone heat setting has been set.









- To select the cooking zone: touch the sensor  again and again until the correct zone indicator is displayed.
- When this function is activated, the  display will come on. Immediately, touch the  to set the time (00 - 99 minutes). When the timer indicator of the cooking zone starts to flash more slowly the time will begin to count down.
- To see the remaining time select the cooking zone with the . The display will show the remaining time.
- To change the count down timer: select the cooking zone with the  sensor and touch  or .
- To deactivate the count down timer select the cooking zone with the  sensor and touch  until the time counts down to 00. The timer indicator will go out.

When the timer count down comes to an end, the cooking zone will deactivate, the 00 will flash and a beep sound will occur for 20 seconds.

The beep sound and flashing can be deactivated immediately by touching the  sensor.

The count up timer





Use the count up timer to monitor how long a cooking zone has operated for.

- The selection of the timer function is only possible if the zone heat setting has been set.
- To select the cooking zone touch the  sensor again and again until the correct zone indicator is displayed.
- To activate the count up timer: Touch . The symbol  goes out and  comes on.
- The display will now start counting up in seconds for the first minute and then minutes after that.
- To deactivate the count up timer: select the cooking zone with  and touch  to deactivate the timer. The symbol  goes out and  comes on.

i IMPORTANT!





When the two timer functions operate at the same time, the display shows the count up timer first.

The Minute minder

You can use the timer as a minute minder when the cooking zones are not in operation. Touch . Then touch  or  of the timer to set the time. When the timer countdown comes to an end, 00 will flash and a beep sound will occur for 30 seconds. The beep sound and flashing can be deactivated immediately by touching the  sensor.

The Stop+Go function





Use the  function to close down all of your operating cooking zones to the lowest heat setting with just one touch.

- To activate this function touch . The indicator will come on and the symbol  will show on all operating zones.
- When  is activated, you cannot change the heat setting.
- To deactivate this function touch  again. The heat setting that you set before comes back on.



USING THE INDUCTION HOB

Deactivating the beep sound

The beeping sound can be deactivated if required.



- First deactivate the hob.
- Then hold down  for 3 seconds. The displays will come on and then go out. Then hold down  for 3 seconds. 60 will now be displayed.
- Touch  and change display to 61. The sound will now be off.
- When the sound is deactivated you will still hear sounds when:
 1. You touch .
 2. You put something on the control panel.
 3. The timer alert comes on.

To reactivate the sound:

- First deactivate the hob.
- Then hold down  for 3 seconds. The displays will come on and then go out. Then hold down  for 3 seconds. 61 will now be displayed.
- Touch  and change display to 60. The sound will now be on.







Lock

Use this function to prevent an accidental change of the heat settings.

- First set the heat setting.
- To start this function touch . The symbol  will then show on all zones for 4 seconds before reverting back to the heat settings.
- The indicator above the lock sensor will remain on.
- Timer functions will continue to operate after the lock is activated.
- To stop this function touch  again. Deactivating the appliance will also stop this function.

Child safety lock

Use this function to prevent an accidental operation of the hob.

- To activate this function, first turn the hob on by touching the  sensor.
- Then hold down the  sensor for 2 seconds.  will then show on all zones for 4 seconds before reverting back to the  heat setting.
- Turn the hob off by touching the  sensor again and the hob is now in a mode where the heat settings cannot be accidentally operated.
- To unlock, first turn the hob back on by touching the  sensor, and then hold down the  sensor again. This will bring the hob back to normal operating mode.

USING THE INDUCTION HOB

Helpful hints and tips

IMPORTANT!

INDUCTION COOKING

Induction cooking uses a strong electromagnetic field to induce energy into the metal of the cookware. This energy makes the cookware become hot.

Cookware for induction cooking

IMPORTANT!

It is important to use cookware that is appropriate for induction cooking. When purchasing cookware always check the manufacturer's specifications.

Cookware material

- **Correct:** cast iron, steel, enamelled steel, stainless steel, the bottom made of multi-layer.
- **Not correct:** aluminium, copper, brass, glass, ceramic, porcelain.

Cookware is correct for an induction hob if...

- some water boils very quickly on a zone set to the highest heat setting.
- a magnet pulls on to the bottom of the cookware.
- The bottom of the cookware must be as thick and flat as possible.

Cooking guide

Heat setting	Use to:	Time	Hints	Nominal power consumption
 1	Keep warm.	as required	Place lid on cookware.	3%
1-3	Hollandaise sauce, melt: butter, chocolate, gelatine.	5-25 min	Mix from time to time.	3-8%
1-3	Solidify: fluffy omelettes, baked eggs.	10-40min	Cook with a lid on.	3-8%
3-5	Simmer rice and milk-based dishes, heating up ready-cooked meals.	25-50min	Add twice as much liquid as rice, mix milk dishes part way through.	3-8%
5-7	Steam vegetables, fish, meat.	20-45min	Add a few tablespoons of liquid.	13-18%
7-9	Steam potatoes.	20-60min	Use max. of 1/4 litre of water for 750g of potatoes.	18-25%
7-9	Cook larger quantities of food, stews and soups.	60-150 min	Up to 3 litres of liquid plus ingredients.	18-25%
9-12	Gentle fry: escalope, veal cordon bleu, cutlets, rissoles, sausages, liver, roux, eggs, pancakes, doughnuts.	as necessary	Turn halfway through.	25-45%
12-13	Heavy fry, hash browns, loin steaks, steaks.	5-15 min	Turn halfway through.	45-64%
14	Boil water, cook pasta, sear meat (goulash, pot roast), deep fry chips.			100%
P	Boil large quantities of water. Power management is activated.			

IMPORTANT!

Information on acrylamides

According to the newest scientific knowledge, if you brown foods (especially those containing starch), acrylamides can pose a health risk. Thus, we recommend that you cook at the lowest temperatures and do not overly brown food.

Use of the cooking zones

IMPORTANT

Always ensure the normal sized cookware is centred over the crosses of the heating zones. Extremely large cookware however cook on two cooking zones at the same time.

ENVIRONMENT!

Energy saving

- If possible, always put the lids on the cookware.
- Put cookware on a cooking zone before you start it.
- Use the residual heat to keep the food warm or to melt it.
- Do not use cookware where the base diameter is smaller than 125mm.

Eco timer

Whenever the countdown timer is used the heat setting will deactivate before the final countdown time is reached. Residual heat left in the cookware will complete the final stage of cooking and hence some energy is saved. The difference in the operation time depends on the heat setting level and the length of the cooking operation.





IMPORTANT!

The data in the table is for guidance only.

INDUCTION HOB TROUBLESHOOTING

If there is a problem with the appliance, please:

- Check the points listed below before calling for service. It may be possible to avoid a call by fixing the problem yourself – and so continue cooking.

Problem	Possible cause	Remedy
You cannot activate the appliance or operate it.		Activate the appliance again and set the heat setting in less than 10 seconds.
	You touched 2 or more sensor fields at the same time.	Touch only one sensor field.
	The Stop+Go function is activated.	Refer to Stop+Go instruction (page 26).
	There is water or fat stains on the control panel.	Clean the control panel.
An acoustic signal sounds and the appliance deactivates. An acoustic signal sounds when the appliance is deactivated.	You have put something on one or more sensor fields.	Remove the object from the sensor field.
The appliance deactivates.	You have put something on the sensor field.	Remove the object from the sensor field.
The residual heat indicator does not come on.	The cooking zone is not hot because it operated only for a short time.	If the cooking zone operated sufficiently long to be hot, speak to the service centre.
The Automatic Heat Up function does not operate.	The cooking zone is already hot.	Let the cooking zone become sufficiently cool.
	The highest heat setting is set.	The highest heat setting has the same power as the Automatic Heat Up function.
The heat setting changes between two levels.	The Power management is activated.	Refer to Power management instruction (page 25).
The sensor fields become hot.	The cookware is too large or you put it too near to the controls.	Put large cookware on the rear cooking zones if necessary.
There is no signal when you touch the panel sensor fields.	The signals are deactivated.	Refer to the OffSound control instruction (page 26).
 comes on.	The Automatic Switch Off has activated.	Deactivate the appliance and activate it again.
 comes on.	The Lock or Child safety lock function is activated.	Refer to the Lock and Child safety lock instruction (page 26).
 comes on.	No cookware is on the cooking zone.	Put cookware on the cooking zone.
	The cookware is incorrect.	Use correct cookware.
	The diameter of the bottom of the cookware is too small for the cooking zone.	Use cookware that has a bottom diameter greater than 125mm.
	The cookware does not cover the cross.	Cover the cross fully.
 and a number comes on.	There is an error in the appliance.	Disconnect the appliance from the electrical supply for some time. Disconnect the fuse from the electrical system of the house. Connect it again. If  comes on again, speak to the service centre.

INDUCTION HOB TROUBLESHOOTING

Problem	Possible cause	Remedy
E3 comes on.	The electrical connection is incorrect. The supply voltage is out of range.	Speak to a qualified electrician to check the installation.
E4 comes on.	There is an error in the appliance because a pot has boiled dry. The overheating protection for the cooking zone and the automatic switch off has operated.	Deactivate the appliance. Remove the hot cookware. After approximately 30 seconds, activate the cooking zone again. If the cookware was the problem, the error message will go out but the residual heat indicator will stay. Check to see if the cookware is appropriate for induction cooking.
E8 comes on.	The electrical connection is incorrect. One or more phases are missing.	Have a qualified electrician check if the installation is correct with the connection illustration. If E8 comes on again, speak to the service centre.
A crack noise can be heard.	Can be caused by cookware made of different materials (sandwich construction).	This is a normal noise from this style of cookware.
A whistle sound can be heard.	Can be caused by one or more cooking zones operating at high power levels and the cookware made of different materials.	This is a normal noise from this style of cookware.
A humming sound can be heard.	Can be caused by one or more cooking zones operating at high power levels.	This is a normal noise and is not caused by appliance malfunction.
A clicking sound can be heard.	Can be caused by electrical switching inside the unit.	This is a normal noise and is not caused by appliance malfunction.
A hissing and buzzing sound can be heard.	Can be caused by the fan operating inside the unit.	This is a normal noise and is not caused by appliance malfunction.

Further information

When you need information, service or replacement parts or have a warranty enquiry, please contact the Customer Care Centre:

- Australia - 1300 363 640, 8.00am - 5.00pm EST Monday to Friday
- New Zealand - 0800 436 245, 8.00am - 5.00pm EST Monday to Friday

Please have the following information ready: Model, Model Number & Serial Number. This is shown on the data plate which is visible when the oven door is open.

USING THE GAS HOB

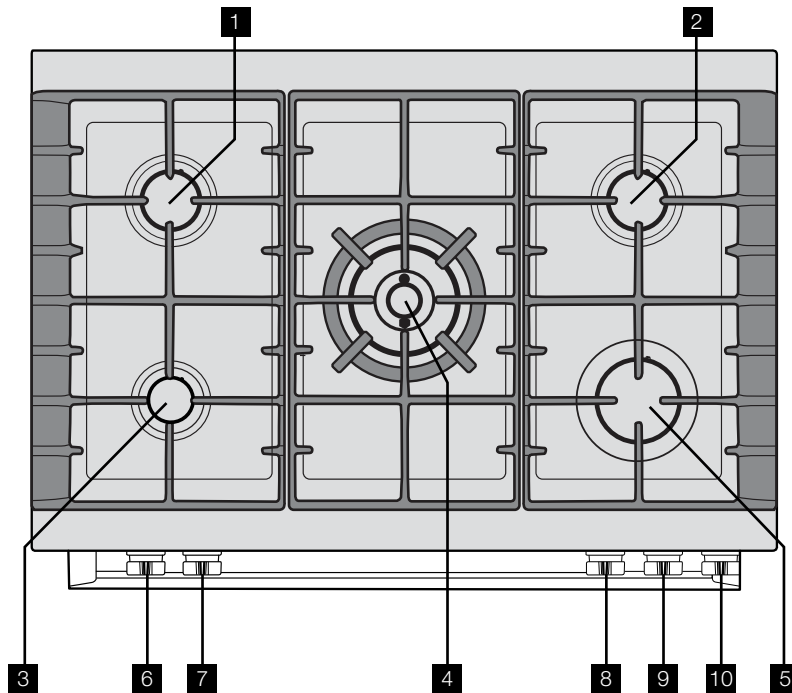

- | | | |
|---|--|--|
| 1 9.0MJ/h Medium heat burners. Used for simmering with mid-sized cookware. | 4 17.0 MJ/h dual valve wok burner. Used for very fast heating with woks and large cookware. | 7 Left hand front burner control. |
| 2 9.0MJ/h Medium heat burners. Used for simmering with mid-sized cookware. | 5 High heat burner. | 8 Wok burner dual control. |
| 3 5.1MJ/h Low heat burner. Used for simmering with small cookware. | 6 Left hand rear burner control. | 9 Right hand rear burner control. |
| | | 10 Right hand front burner control. |

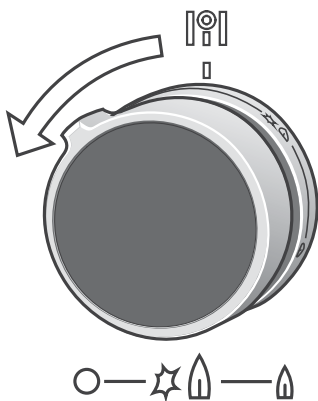

Control knob for high, medium & low heat burners

To light a burner with this knob, firstly depress and turn anti-clockwise to the 'HI' flame position. The knob may be released once the flame is established and turned further anti-clockwise to reduce the flame height as desired.

NOTE: If the flame goes out when either knob is released, simply depress the knob again, this time holding it down for approximately 5 seconds.

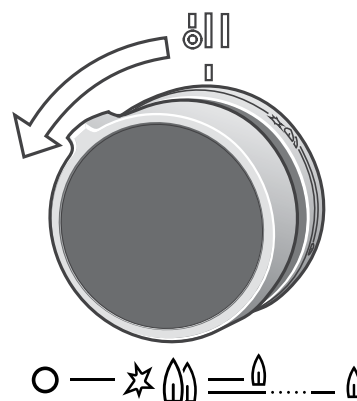

Control knob for the wok burner

To light the wok burner, depress the knob and turn anti-clockwise to ignite the inner and outer burners. The knob may be released when both inside and outside flames are established. Turning the knob further anti-clockwise will reduce the height of the outer flame.

Turning the knob further to the single flame/single line will extinguish the outer flame and control the height of the inner flame.

Turning the knob clockwise back to the double flame will reignite the outer flame.

GAS HOB TROUBLESHOOTING

If there is a problem with the appliance, please:

- Check the points listed below before calling for service. It may be possible to avoid a call by fixing the problem yourself – and so continue cooking.

Problem	Possible cause	Remedy
Burner will not light even though the sparker is working.	Knob not held down long enough in 'High' position for flame safeguard to engage.	Repeat lighting procedure and hold knob down for 5 seconds in 'High' position.
	Gas supply valve turned off.	Turn on gas supply to appliance.
	Wrong knob turned off.	Ensure the knob you are turning corresponds to the burner you want to light.
No spark is obtained when control knob is activated.	Port blockage in ignition area.	Ensure the ports in the ignition area are clean and dry.
	Ignition spark plugs wet or dirty.	Dry or clean ignition spark plugs.
	Electricity supply is disconnected or switched off.	Switch on electricity or check fuses.
Flames uneven or tending to lift.	Ignition spark plugs wet or dirty.	Dry or clean ignition spark plugs.
	Flame ports blocked or wet.	Clean or dry flame ports.
Flames not staying on when knob released.	Burner incorrectly fitted.	Ensure this component is fitted correctly.
	Knob not held down long enough in 'High' position for flame safeguard to engage.	Repeat lighting procedure and hold knob down for 5 seconds in 'High' position.
Low heat, slow cooking.	Knob not set between 'High' and 'Low'.	Knob MUST be set between these positions.
	Dirt or spillage on flame safeguard sensor.	Clean flameguard sensor tip.
	Incorrect cooking burner selection for the size of pot being used.	Refer to page 31 for correct burner selection.

Flame safeguard

The gas hob is fitted with a safety system that will stop the flow of gas if for any reason the flame goes out during operation. If this happens, the burner can be restarted, but will require the knob to remain depressed for approximately 5 seconds.



WARNING!

- Keep hands clear of burners when lighting.
- If burner does not ignite within 5 seconds, turn knob to 'Off' position, allow gas to disperse, then try lighting again.
- Burners MUST be operated between 'HIGH' and 'LOW' settings only.



ENVIRONMENT!

To conserve gas, place the pan centrally over the burner and adjust the flame so that it does not go past the edge of the cookware.

NOTE: In the absence of electrical power, carry out the ignition directly to the burner with a hand held ignition source.

Further information

When you need information, service or replacement parts or have a warranty enquiry, please contact the Customer Care Centre:

- Australia - 1300 363 640, 8.00am-5.00pm EST Monday to Friday
- New Zealand - 0800 436 245, 8.00am-5.00pm EST Monday to Friday

Please have the following information ready: Model, Model Number & Serial Number. This is shown on the data plate which is visible when the oven door is open.

CLEANING YOUR APPLIANCE - PYROLYTIC OVENS

EVEP916SB,EFEP955SB & EFEP915SB

Cleaning Reminder

After a recommended period of time the oven will remind you to clean the oven. Once this period of time has elapsed, when turning the oven off you will get a message "TIME TO CLEAN YOUR OVEN". Press the on/off button to clear the message and run the pyrolytic cycle. After the pyrolytic cycle has finished, the cleaning reminder will reset. The "Cleaning Reminder" setting can be enabled/disabled in the settings menu.

Alternatively while the "TIME TO CLEAN YOUR OVEN" message is displayed, you can press the "ok" button and you will get the option to "REMIND ME AGAIN".

Pyrolytic cleaning of the oven cavity

The oven has the Pyrolytic self-cleaning function, it cleans by burning off the spatters and accumulated dirt and grease from the oven liner, at high temperature. This process produces ash which can then be wiped out of the oven cavity.



WARNING!

During the pyrolytic cleaning process the oven becomes extremely hot.

DO NOT use Hob during Pyrolytic cleaning

- Please keep small children at a safe distance.
- Never clean non-stick baking trays and tins in the oven during the pyrolytic cycle. High temperatures damage the non-stick coating and poisonous gas is released.
- To prevent damage, do not use acids, sprays or similar cleaning agents.



CAUTION!

- **During pyrolytic cleaning the air outlet exhaust above the door must be kept clear of any obstruction (e.g. bulky tea towels).**
- **Do not use your oven to clean miscellaneous items (e.g. cookware).**

Before carrying out the Pyrolytic function

1. All accessories must be removed from the oven, including shelves, trays and side racks.
2. Clean large deposits, spills or grease from the oven cavity.
3. Choose your Pyrolytic cleaning cycle from the following:

Soiling	Duration
light clean	1hr 30mins
medium clean	2hrs
heavy clean	2hr 30mins

Note: Duration includes heat-up time, excluding cool-down time.

Light clean

This is an energy saving cycle that can be used on a regular basis if the oven is lightly soiled. Possibly after every 2nd or 3rd roast.

Medium clean

Use this as the regular cycle about once every 2-3 months.

Heavy clean

When the oven is very dirty it may need a longer cycle to clean it thoroughly. This cycle will clean the dirtiest of ovens.

CLEANING YOUR APPLIANCE

Select the pyrolytic clean function.

Use cooking function selector to pick the 'pyro clean' function.

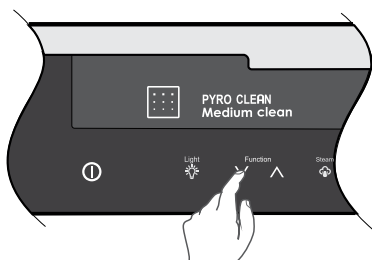

Selecting the required cleaning cycle

Use the 'cook time' control to select Light, Medium or Heavy depending on the soiling of the oven.

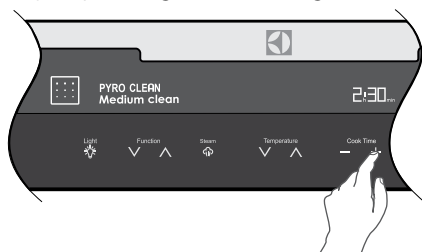

Start Pyrolytic

Unlike other cooking functions, you **MUST** touch 'OK' for the pyrolytic cycle to start. The display will prompt you to remove all shelves and trays. You must touch 'OK' again to start. The oven light will then go out and the Pyrolytic function will start.

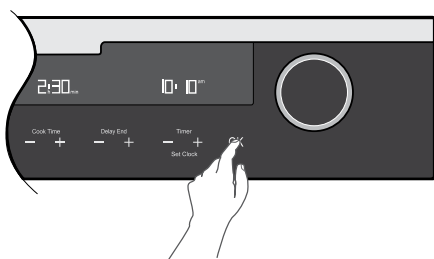

i IMPORTANT

At the beginning of pyrolytic cleaning the door will automatically lock  will appear on the display. During the pyrolytic cleaning cycle there may be some burn off odours. It is advised to keep the room well ventilated during this cycle.

The door will only unlock when the oven has cooled to a safe temperature. Turning the function off will not unlock the door. This will only happen when safe temperatures are reached.

When the pyrolytic cleaning function is on, it is advisable not to use a cooktop. This may cause overheating and damage.

NOTE: The cooling fan will operate at an increased speed for Pyrolytic cleaning and will continue to run until the oven has cooled down. This is normal.

It is recommended to clean the oven regularly to keep it in its best condition.

After Pyrolytic cleaning

After cool-down wipe the ash out of the oven with a soft damp cloth and warm water.

To restore the enamel shine to more difficult areas, use a damp cloth with vinegar and detergent.



CAUTION

Do not turn off the mains power supply to the oven during the pyrolytic cycle. This could damage the appliance.

CLEANING OVEN ACCESSORIES



WARNING!

- Always make sure that the appliance is electrically isolated before cleaning. This can be done by the functional switch nearby.
- Do not line the bottom of the oven with foil or cookware.
- Do not use steam cleaners.

Stainless steel parts



WARNING!

The oven door trim, the control panel trim and the storage compartment are made from a special stainless steel that resists fingermarks and should only be cleaned with warm water and a mild detergent. Do not use stainless steel cleaners, abrasive cleaners or harsh solvents on these parts.

NOTE: Make sure you follow the polish or brushing lines in the stainless steel.

- All grades of stainless steel can stain, discolour or become greasy. You must clean these regularly by following the procedures below if you want your appliance to look its best, perform well and have a long life.
- Care must be taken when wiping exposed stainless steel edges, they can be sharp!
- The stainless steel gas hob, side panels and kick panel can be cleaned with stainless steel cleaners if it becomes soiled or discoloured.
- A suitable cleaner can be purchased from Electrolux Customer Care Centres.

Oven door

- DO NOT use the oven without the inner and middle door glass fitted.
- NEVER spray any caustic cleaners on any surface of the door or damage to the surface coatings will result.
- DO NOT use metal utensils, scrapers, scourers, or abrasive cleaners to clean the glass or any of the door trims. These will damage or scratch the surface coatings and degrade the finish and appearance.
- DO NOT place glass in dishwasher.
- Use only warm water and liquid detergent with a soft cloth to clean the glass or trims.
- Before refitting the glass panes to the door ensure they are dried with a soft cloth.
- The glass edges have been specially ground to remove any sharp edges. However it is glass, and should be handled carefully to avoid injury to your person and damage to the glass.
- Ensure glass panels are refitted to the door in the same order and orientation they came out from.

Gas hob

- The trivets can be removed for cleaning by carefully lifting them from the hob.
- Clean by washing with warm soapy water.
- The burner caps and crowns are also removable for cleaning.
- If the caps, crowns and cups are heavily soiled, use a non-abrasive cleaning compound.
- Flame port blockages should be removed by using a matchstick or brush.
- Do not clean them with abrasive or caustic type cleaners, or clean them in a dishwasher.
- The hob glass can be cleaned with the supplied razor blade scraper.

Induction hob

- Remove all spilt food and fat with the supplied razor blade scraper, while the ceramic glass is still warm but not hot. Wipe clean with dishwashing detergent on a damp cloth.
- If aluminium foil, plastic items or high sugar content foods are allowed to melt on the ceramic glass, clean immediately with the supplied razor blade scraper before the surface has cooled down, otherwise pitting of the surface can occur.

NOTE: Items with high sugar content not only include jam and fruit, but also vegetables such as peas, tomatoes and carrots.

- When the ceramic glass is cool, apply a suitable ceramic glass cleaner.
- It is important to follow the cleaner manufacturer's instructions. Remove any cleaning residue from the surface as staining of the cooktop may occur.
- Do not use abrasive sponges or scourers, as they may scratch the surface.
- Any pitting, staining, scratches or other surface deterioration is excluded from the warranty.
- Sometimes SURFACE stains appear to be 'bubble' marks under the ceramic glass. These can be cleaned off with a razor blade scraper and ceramic cleaner.

Oven

- Always keep your appliance clean. Ensure that fats and oils do not accumulate around elements or fans.
- Always keep the oven dish, baking trays, grill dish and grill dish inserts clean, as any fat deposits may catch fire.
- Always wrap your meats in foil or an oven roasting bag to minimise cleaning. Any polyunsaturated fats can leave a varnish-like residue which is very difficult to remove.

Grill

- Always keep the grill dish and grill dish insert clean, as any fat deposits may catch fire.

CLEANING THE OVEN DOOR

Removing the shelves and grill dishes

- Slide the shelves and grill dish carrier towards you until they reach the front stop.
- Tilt them up at the front to clear the side supports, taking care not to spill the contents.
- Lift them clear.
- Wash the shelves and grill dish in hot soapy water.
- Reverse the above steps to put the shelves and grill dishes back again.
- Ensure that they are placed between the 2 support wires or correctly onto the runners.

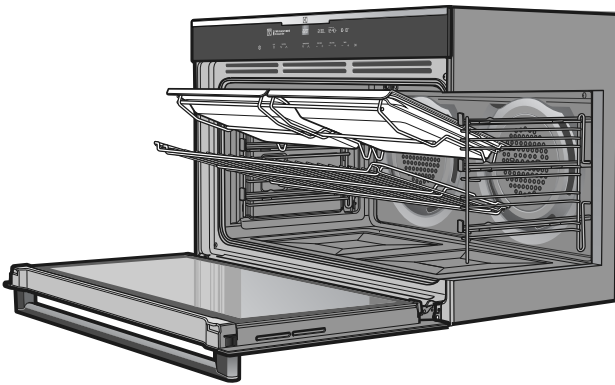

Releasing the grill element

To release the grill element so that the oven roof can be accessed for cleaning.

- Push element upwards and rotate the 3 clips backwards and away from the element rod. This will allow the front of the element to drop down.

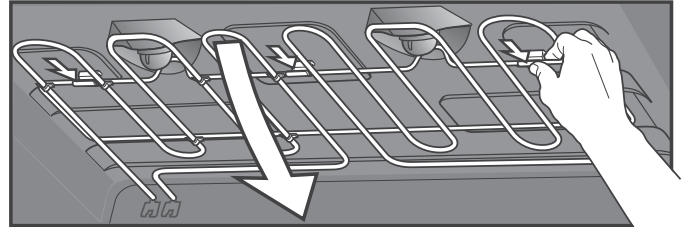

WARNING

The door glass on this appliance is made from a tough, durable material that withstands heating and cooling without breaking. However, it must be remembered that it is **GLASS**, it may break. Treat it accordingly! Should you have any questions about the glass in your new appliance, please contact the customer care centre by dialling 1300 363 640.

Do not use harsh abrasive cleaners or sharp metal scrapers to clean the oven door since they can scratch the surface, which may result in shattering of the glass.

Removing the shelf supports

- Grasp the shelf support at the front.
- Pull it firmly inwards.

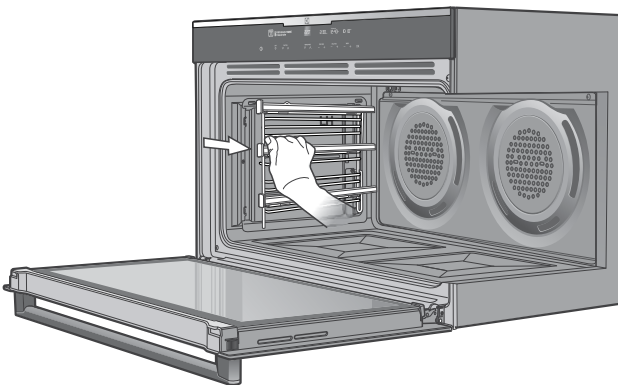

INSTALLATION OF THE EFEP955SB & EFEP915SB

Positioning the door for dismantling

The door needs to be positioned at an angle to aid in the disassembly of the panes.

- Open the door fully to gain access to the hinges.
- Push down the hinge locking tab on both hinges.

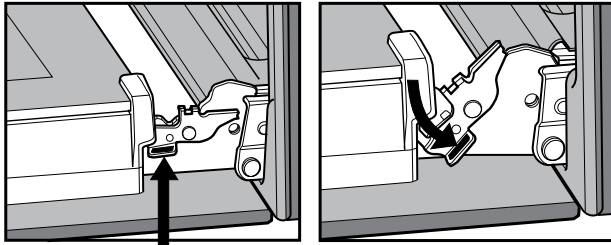

Locking tab up - normal position Locking tab down - for cleaning

- Gently close the door until it stops in the partially open position on the locking tab.

NOTE: The door cannot fully close with the locking tab in this down position.

Removing the top door trim

- Push in the 2 tabs on either side of the trim.
- Lift the trim away from the door.

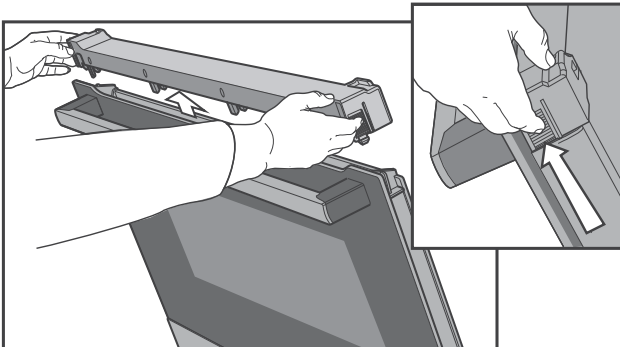

Removing the glass panes

- Remove the inner glass and middle glass layers from the door.
- Clean the glass using detergent and warm water. Wipe clean and dry thoroughly.
- The outside glass cannot be removed from the door and hence can be cleaned in-situ.

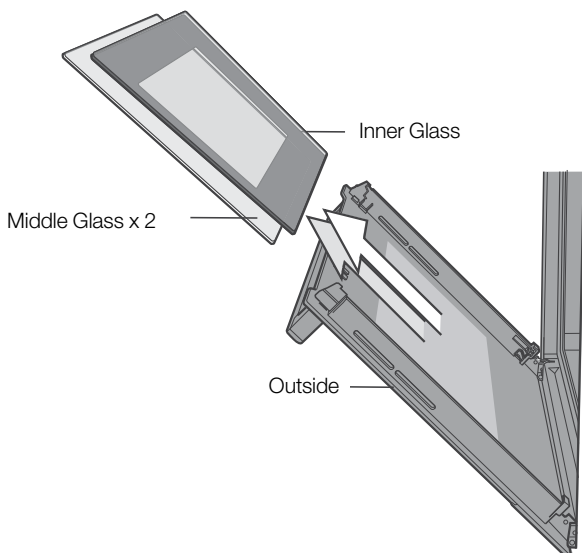

Reassembling the glass panes & and top door trim

- Replace the middle glass back to the door first. The middle glass is a clear pane and orientation of the glass is not important.
- Replace the inner glass next ensuring the side that is painted is facing away from the oven cavity.
- Replace the top door trim ensuring the 2 side tabs have clipped into the column.
- Pull the hinge locking tabs back up and close the door.

Changing the light globes

- Switch the appliance off at the isolation switch before attempting to change the light globe.
- There are 2 light globes located in the top of the oven cavity towards the rear.
- To get access to the globes, firstly drop the element down as explained on page 34.
- To remove, turn oven light glass anti-clockwise.
- A special high temperature resistant borosilicate globe should be used. This can be purchased from the Customer Care Centre.

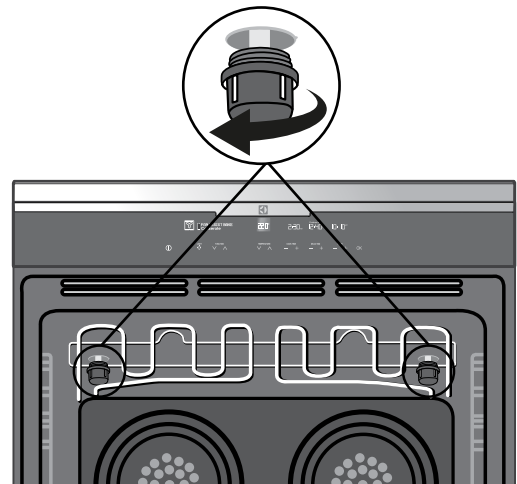

Storage compartment (selected models)

The storage compartment is accessible through the pivoting door.

Unused oven racks and grill dishes can be stored here.

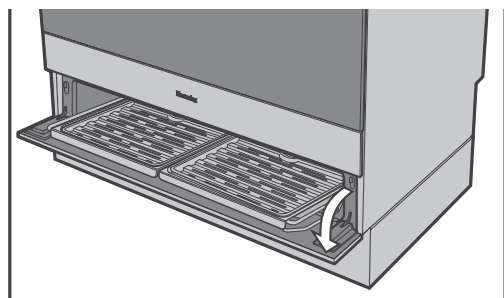

! WARNING!

DO NOT store flammable or combustible items in the storage compartments. This is not a compartment for warming food.

INSTALLATION OF THE EFEP955SB & EFEP915SB

Installing splashback (Models with hob only)

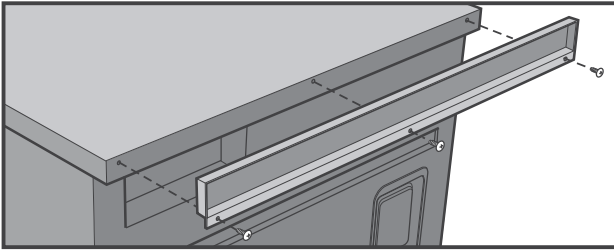

Fit splashback to rear of hob with three screws provided.

Cabinet requirements

Models EFEP955SB & EFEP915SB are designed to fit into a 900mm wide gap between standard kitchen cabinets. The appliance integrates with the kitchen cabinets by matching the height, depth and kick panel. The cooker may also be installed at the end of a line of benches or with a free space either side. In addition, a slot-in type installation is catered for allowing a continuous cabinetry kick panel to be used. Model EVEP916SB is designed to be built into cabinetry either below a benchtop or into a vertical cabinet.



WARNING!

- The cooker must be installed and serviced only by an authorised person.
- A Certificate of Compliance MUST be supplied to be kept by the customer.
- The packing materials must be removed before you install the cooker.
- The surrounding kitchen cabinets must be able to withstand 85°C. Electrolux WILL NOT accept responsibility for damage caused by installation into kitchen cabinets which cannot withstand 85°C.
- The pipes used for installation MUST have sufficient loops so the cooker can be moved for service (gas model).
- The vents, openings and air spaces MUST NOT be blocked.
- The anti-tilt brackets and chain or front stops MUST be installed to avoid accidental tipping (freestanding and slot-in models).
- You MUST NOT lift or pull the cooker by the door handle.
- The cooker MUST be checked every five years.
- The appliance must not be installed behind a decorative door in order to avoid overheating.

Gas model clearance requirements

- Ensure the appliance is installed in accordance with clauses 6.2.5 and 6.10.1.1 of AS/NZS 5601.1 or clauses 6.9.1 and 6.9.5 of AS/NZS 5601.2 with regard to clearances to combustible surfaces and materials, and clearances to rangehoods and exhaust fan. To ensure clearances of 200mm from burners to vertical combustible surfaces observe the minimum dimension of 100mm from each side of the cooker to combustible surfaces.
- Clearances to combustible surfaces may be reduced if combustible surfaces are protected in accordance with clause 6.10.1.2 of AS/NZS 5601.1, or clause 6.9.2 of AS/NZS 5601.2.
- When setting the cooker height, ensure the top of the cooker is at least 10mm higher than the level of the benchtop.

INSTALLATION OF THE EFEP955SB & EFEP915SB

Cabinet construction for freestanding installation

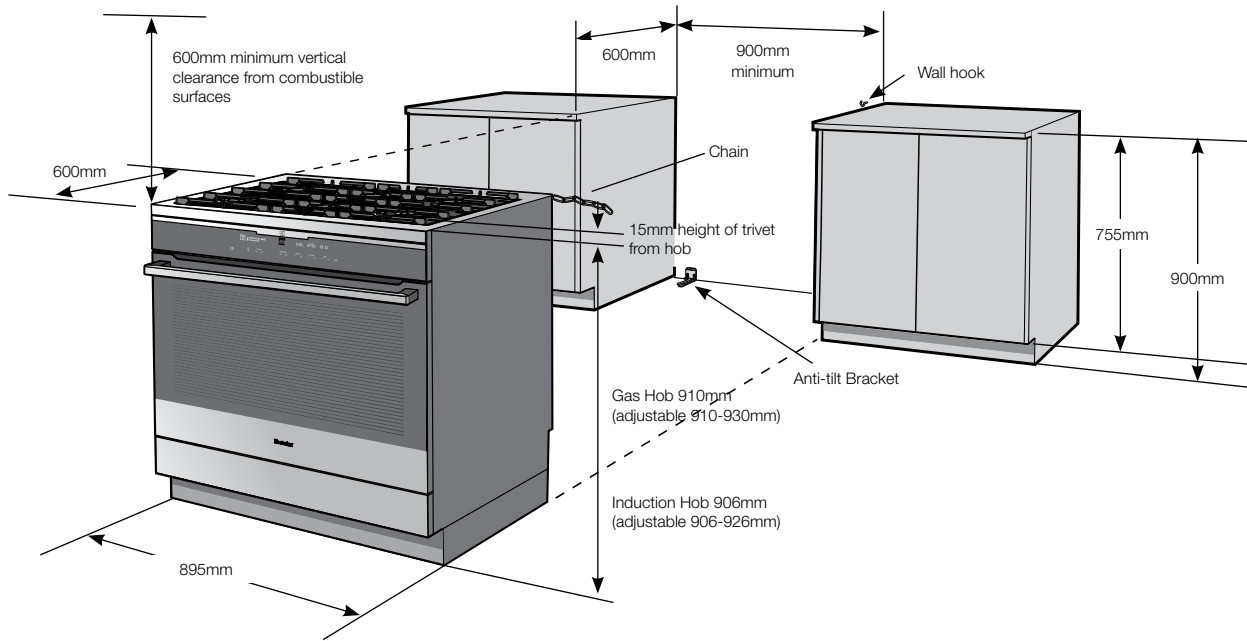

The freestanding type installation uses the appliance as supplied, and can be fitted in between cabinets, with cabinets on one side or without adjacent cabinets. There is no clearance requirement to adjacent side cabinets.

To ensure cooker stability, the anti-tilt brackets must be installed, and the end of chain attached to the appliance must be placed onto the hook attached to the rear wall.

Installation of anti-tilt brackets and hook

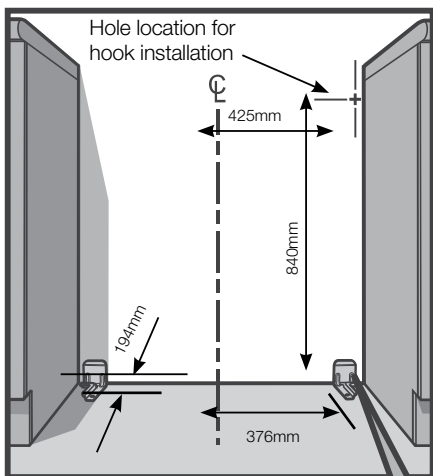

Measurements are to be adjusted to account for the thickness of any skirting board or tiles coming between the back of the appliance and the wall

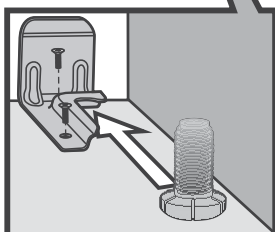

- The anti-tilt brackets must be secured to the floor at rear of cavity with an appropriate fastener according to dimensions in diagram.
- The hook is to be secured to the back wall in the location shown above with an appropriate fastener capable of withstanding a 10kg load.
- Connect services to the appliance prior to placing into cavity.
- To locate appliance, slide into cavity ensuring the rear left and right foot of appliance are captured by the anti-tilt brackets.
- Before the appliance is fully pushed into position, place the chain attached to the rear of appliance onto the wall hook.

INSTALLATION OF THE EFEP955SB & EFEP915SB

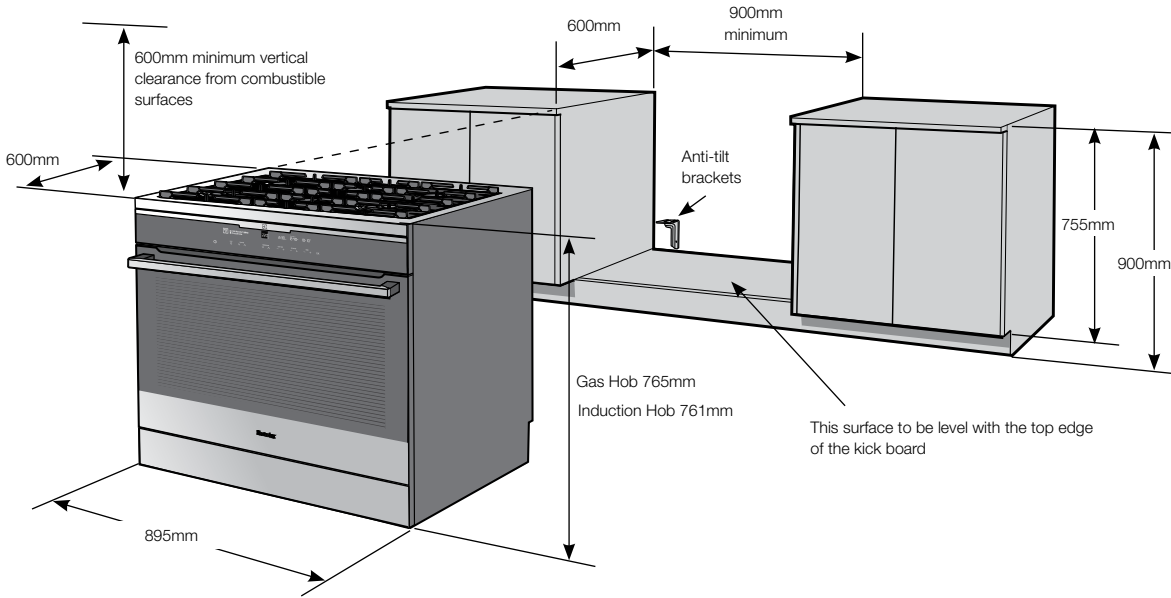

Cabinet construction for slot in installation

To convert the freestanding appliance to a slot in installation the kick panel provided on the appliance is removed and the appliance is mounted on a plinth. This enables a continuous cupboard kickboard to be installed, giving a more integrated appearance. There is no clearance requirement between oven and adjacent side cabinets.

Installation of anti-tilt brackets and stops

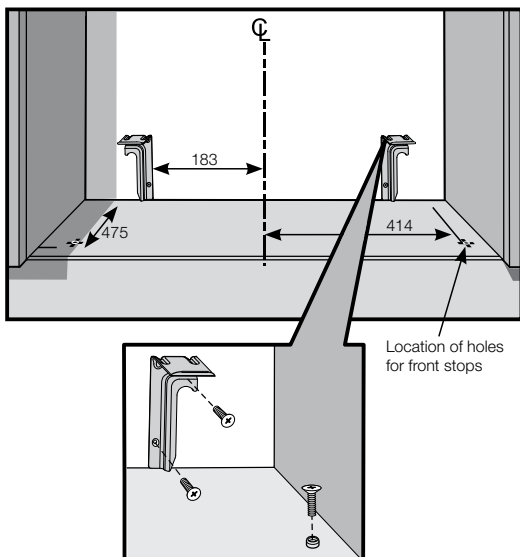

- The brackets are to be secured to the back wall with appropriate fasteners.
- The bottom edge of the brackets rest on the horizontal support surface.
- Two stops are to be screwed to the plinth in locations as shown (stops provided). The stops locate into slots in the base of the appliance to prevent the product from being pulled forward when installed.
- Measurements from the rear wall are to be adjusted if there are tiles etc, that come between the appliance and the wall.
- Once services are connected, product can be lifted onto the plinth and pushed back carefully, ensuring the appliance engages into both brackets at the rear and the front stops.
- If the product requires removal for service, it must be lifted at the front approximately 5mm to clear the front stops prior to being pulled forward.

INSTALLATION OF THE EFEP955SB & EFEP915SB

Slot in Installation

To remove the appliance kick panel

- Remove all loose parts i.e. burner crowns & caps, trivets, and oven shelves.
- Carefully lay down the appliance onto one side onto foam packaging and remove the screws as shown from each corner bracket.

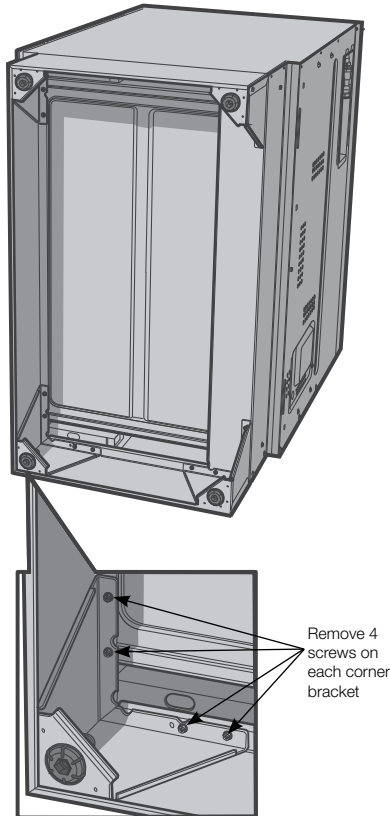

Installation sequence for freestanding or slot-in installation

- Check that the required services are correctly positioned (see electrical & gas services requirements).
- Ensure cabinetry has the correct details.
- Install anti-tilt brackets and chain hook or front stops as appropriate.
- Remove all packaging from cooker, remove all loose parts i.e. trivets, burner crowns, oven shelves.
- Remove plastic film from cooker.
- Fit splashback to cooker.
- Slide cooker into position to check fitment to anti-tilt bracket. For freestanding installation, check the height and level of the cooker. Adjust cooker feet as required.
- Connect gas and electrical services.
- Place into position.
- Complete Certificate of Compliance.

INSTALLATION OF EVEP916SB

Cabinet construction for built-in installation

For the best integration within a kitchen, install this appliance in a cupboard that gives a **flush fit** with the surrounding cupboard fronts. A recess of 20mm is ideal.

The appliance may also be mounted in a **proud fit** configuration. This will push out the front of the product from the cupboard front by 20mm.

*NOTE 20mm slot at rear of oven in base.
Cleats to be a maximum of 100mm wide*

Underbench installation

Your underbench oven looks best when the control panel is directly under the benchtop. An upper infill panel may be added if the cooktop placed above the benchtop is too deep. *Refer to cooktop installation instructions for required clearance between cooktop and oven.

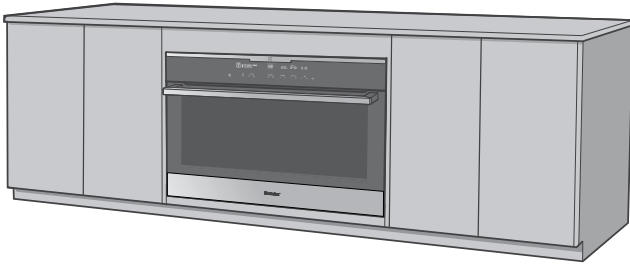

Vertical cabinet installation

The oven can be built into a vertical cabinet in the same manner as an underbench. The required cavity dimensions are the same and the product is secured to the cabinet in the same way.

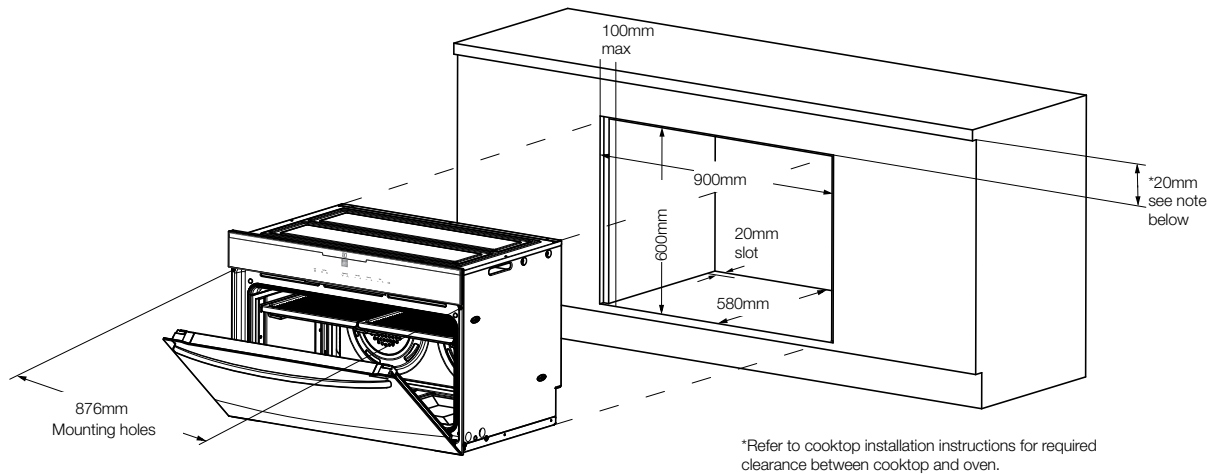

NOTE: If a powerpoint is fitted it must be accessible with the appliance installed.

CABINET CONSTRUCTION FOR BUILT IN OVEN

For the best integration within a kitchen, install this appliance in a cupboard that gives a flush fit with the surrounding cupboard fronts. A recess of 20mm is ideal.

NOTE: Your appliance must be mounted on a horizontal surface for the full width and depth of the product.

NOTE: A ventilation slot 20mm wide is required at the rear of the base of the cabinet floor.

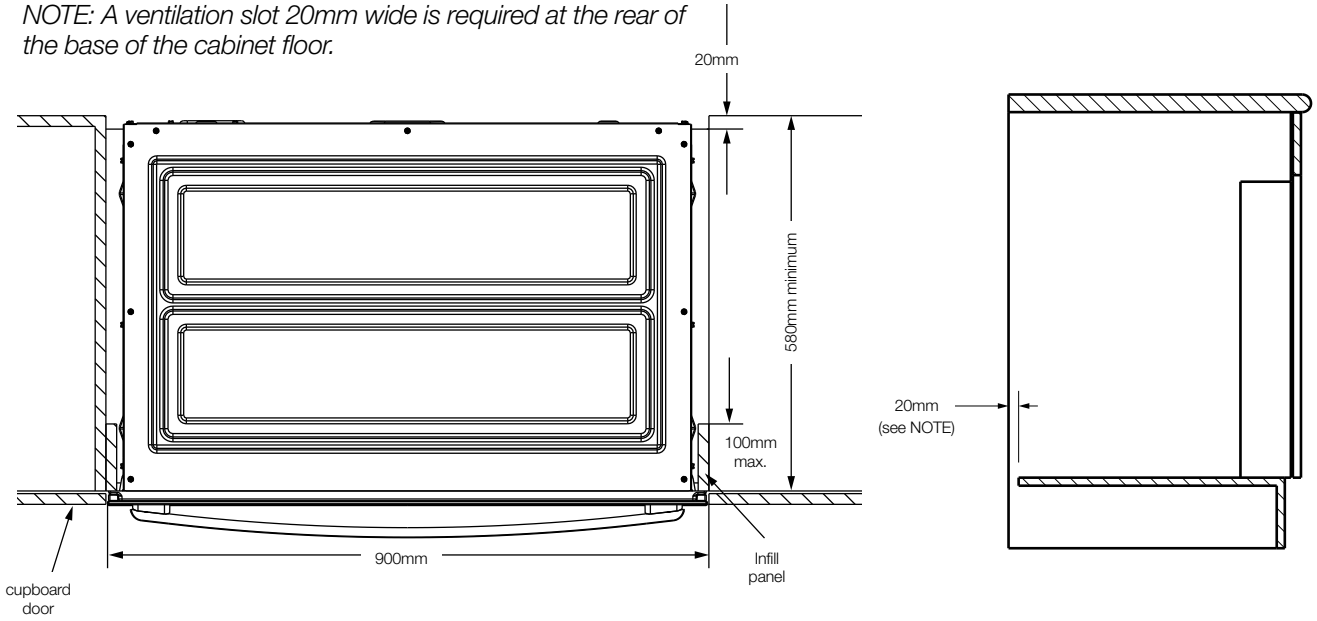

Oven dimensions

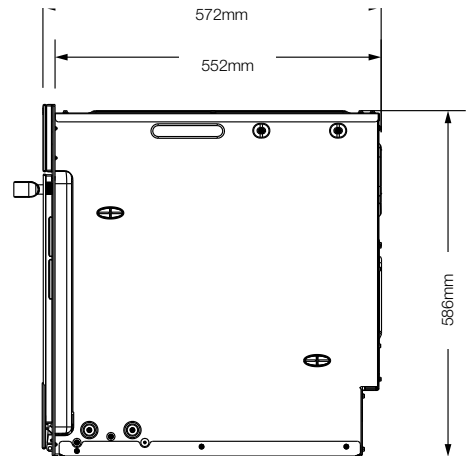
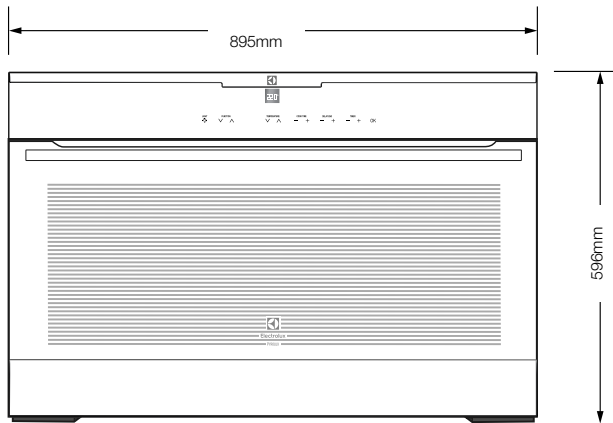

WIRING REQUIREMENTS

The cooker MUST be installed in compliance with:

- Wiring connections in AS/NZS 3000 Wiring Rules.
- Local regulations, municipal building codes and other statutory regulations.

For New Zealand Only:	
The cooking range must be connected to the supply by a supply cord fitted with the appropriately rated plug. This plug is to be compatible with the socket-outlet fitted to the final sub-circuit in the fixed wiring that is intended to supply this cooking range.	
Supply cord size required	
EVEP916SB, EFEP915SB - 4mm ² EFEP955SB - 10mm ²	
Data plate	gives information about rating is located behind the bottom of the oven door

- A functional switch MUST be provided near the appliance in an accessible position (AS/NZS 3000 - Clause 4.7.1).
- Wiring MUST be protected against mechanical failure (AS/NZS 3000 - Clause 3.9).
- The cooker requires a means of all pole disconnection incorporated into the fixed wiring. This MUST have a disconnection gap of 3mm.
- The cooker MUST be properly earthed.
- This range must be connected with cable of 75°C rating minimum.
- This product has passed the insulation resistance test after manufacture. If the resistance reading is low at installation, it is probably caused by moisture from the atmosphere being absorbed by the elements after the range has been produced. (Pass at 0.01 MΩ AS/NZS 3000 Wiring Rules Clause 8.3.6.2).

NOTE: When connections are made to a multi-phase 230/240V supply, the bridge piece MUST be removed from between the active connections.

Rated Power Input

Model	Total kW	A1 kW	A2 kW
EFEP955SB	15.5	6.0	9.5

i IMPORTANT!

Before you cook in your new oven it is important that the protective oils used in the manufacture of the product be removed.

- Make sure that the room is well ventilated (to allow smoke to escape).
- Run the grill on high for 30 minutes without grill dish.
- Then run the oven on 220°C for 1 hour.

Connecting to services and commissioning

This appliance must be installed by an authorised person, according to all codes and regulations of:

- Electrical supply authorities.
- Building regulations.
- Local government and council authorities.
- AS/NZS5601.1 (particular attention to 6.10.1 and figure 6.3, and clause 6.10.1.11).
- AS/NZS 3000 (particular attention to clause 4.3.11 and clause 3.9).

Hard wiring detail

1. Remove terminal cover plate from rear panel of appliance.
2. Fit wires through hole in cover plate and make connections to terminals.
3. Engage wires into plastic clip. Secure plastic clip with two long silver screws (supplied in separate bag).
4. Replace cover plate onto rear panel.

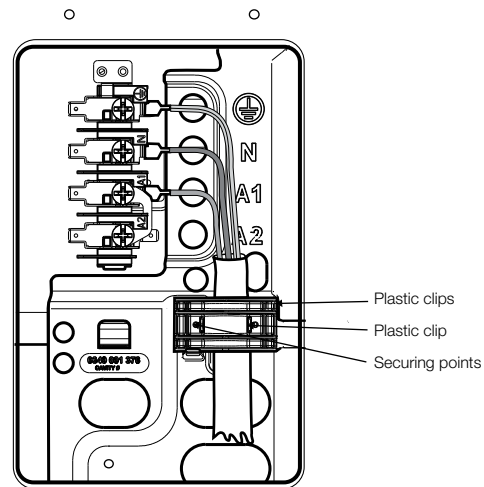

Electrical connection location - Model EVEP916SB

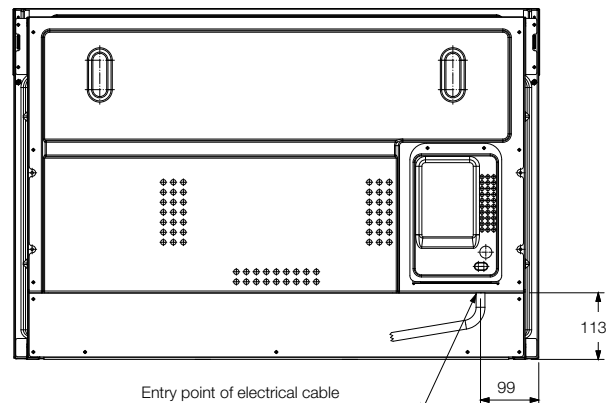

ELECTRICAL & GAS CONNECTION LOCATIONS

Models EFEP915SB

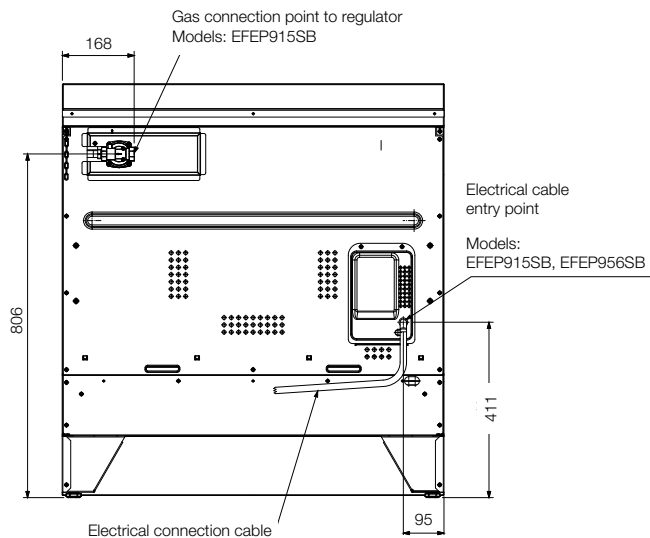

Installing the gas cooker

Gas pressures

The following table shows the supply and operating pressures for various gases.

Gas type	Natural gas	Universal LPG
Supply pressure at inlet to appliance regulator	1.13 (kPa)	2.75
	Minimum	kPa
Operating pressure at appliance test point	1.00 (kPa)	2.60 kPa

The following table shows the injector sizes for each burner.

Injector Orifice	Natural gas	Universal LPG
Low heat burner	1.00mm	0.55mm
Medium heat burner	1.35mm	0.70mm
High heat burner	1.60mm	0.90mm
Intense heat dual wok burner	0.85mm (inner)	0.46mm (inner)
	2 x 1.25mm (outer)	2 x 0.73mm (outer)

Checking piping size

To work out a suitable pipe size for connection use the information in this table:

Model	Natural gas	Universal LPG
EFEP915SB	52.2 MJ/h	44.9 MJ/h

For information and requirements about construction and capacity of consumer piping refer to AS5601 series of standards.

Gas connection

Read these points before connecting to the gas supply:

- The appliance is preset for natural gas use. If LPG is to be used see Conversion to LPG section.
- Gas installation must be made in accordance with AS5601, the local gas fitting regulations, municipal codes and other statutory regulations.
- The gas connection point is a 1/2" BSP external thread located at the rear of the appliance as shown.
- A regulator is supplied which must be fitted to the appliance. Ensure that when fitted the pressure test point of regulator is accessible.
- The regulator is to be fitted to the manifold inlet at the rear of the appliance and the connection thread is sealed using a tape or jointing compound suitable for gas connections. The consumer piping is then connected to the inlet of the regulator, either:
 1. directly, or
 2. using a hose assembly and in accordance with Clause 6.10.1.9 of AS 5601.1 (High level connection) together with the supplied elbow. The elbow is fitted to the inlet of the regulator and oriented to allow the hose to hang downwards. The connection thread between the regulator and elbow is sealed using a tape or jointing compound suitable for gas connections.

LPG CONVERSION MODEL EFEP915SB

This appliance is supplied set up for Natural Gas usage. A conversion kit is included with the product for Universal LPG usage. The conversion kit contains 10 injectors and 1 LPG sticker.

Please follow the procedure below if a conversion to suit UNIVERSAL LPG is required:

1. Remove the hotplate trivets, burner caps and burner crowns to access the hotplate injectors. Replace the factory fitted injectors with the appropriate injectors, as supplied. Refer to injector orifice table for injector sizes. The injector size is stamped on the side of the injector.
2. Unscrew the top hat nut from the regulator. The top hat nut and control pressure spring assembly will disengage as an assembly.
3. Unscrew the threaded pin from top hat.
4. Upright threaded pin, so spring is free and screw pin back into the top hat until firm.
5. Refit the top hat nut assembly to the regulator ensuring that it is fully screwed down. The regulator is now set for connection to LPG.
6. Turn on the gas supply and at each new connection check for leaks using soapy water. Each hotplate valve should be turned on, one at a time, and the injector hole blanked off for several seconds.
7. The operation of the regulator can be confirmed by connecting a manometer to the pressure test point located on the side of the regulator body adjacent to the outlet.

With the appliance operating check the outlet pressure:

- when all burners of the appliance are operating at maximum,
- when the smallest burner of the appliance is operating at minimum.

Under these conditions the outlet pressure should not vary from the nominal outlet pressure of 2.60kPa by more than ± 0.52 kPa.

8. If the regulator appears to not be performing satisfactorily then check the following points:
 - If the outlet pressure is consistently too low then the inlet pressure may be too low and adjustment of an upstream regulator may be needed, or an upstream regulator or valve with insufficient flow capacity may be present in the gas supply line. If this is suspected then it may be necessary to repeat the checks whilst measuring both the inlet and outlet pressure to determine if the inlet pressure is in the range 2.75 – 7.00kPa.

- Check that the insert has been fitted correctly.
- Check that the turret screw is fully screwed down.
- Check that the regulator has been fitted to the gas supply line in the correct orientation, the arrow on the base of the body indicates the direction of gas flow.

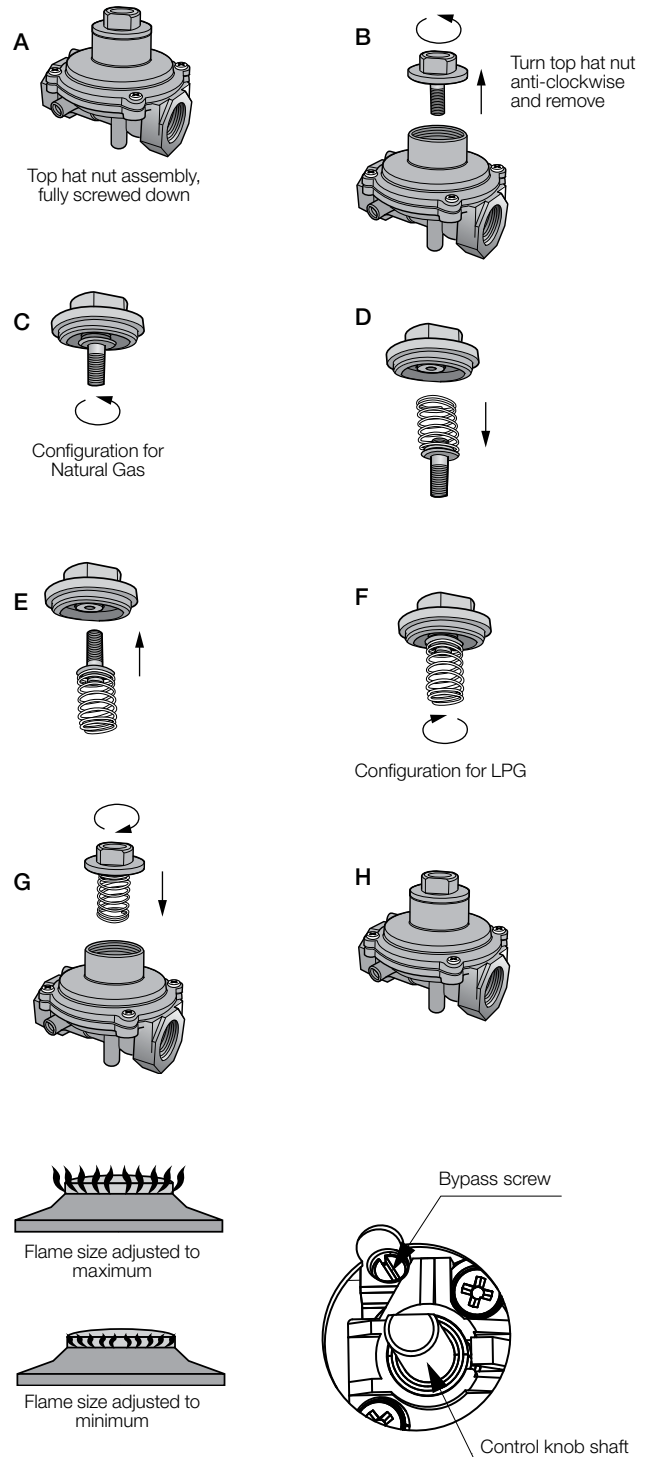

NOTE: The cooker **MUST** be tested after installation, before handing over to the customer. You **MUST** have a manometer and a connecting tube.

TESTING THE OPERATION OF THE GAS COOKER

Checking gas supply

1. Check the manometer zero point is correct.
2. Connect the manometer to the cooker pressure test point. This is located on the regulator.
3. Turn on the gas supply and the electricity and try to ignite the gas.

NOTE: It will take additional time to light the gas for the first time as air needs to be purged from the pipes.

4. Check the operating pressure for the particular gas type.

Checking the function of the regulator

With the appliance operating check the outlet pressure:

- When all burners of the appliance are operating at maximum,
- When the smallest burner of the appliance is operating at minimum.

Under these conditions the outlet pressure should not vary from the nominal outlet pressure by more than $\pm 20\%$ of the nominal outlet pressure (i.e. $\pm 0.20\text{kPa}$ for Natural Gas).

If the regulator appears to not be performing satisfactorily then check the following points:

1. If the outlet pressure is consistently too low then the inlet pressure may be too low and adjustment of an upstream regulator may be needed, or an upstream regulator or valve with insufficient flow capacity may be present in the gas supply line. If this is suspected then it may be necessary to repeat the checks whilst measuring both the inlet and outlet pressure to determine if the inlet pressure is in the range 1.13 – 5kPa.
2. Check that the regulator has been fitted to the gas supply line in the correct orientation, the arrow on the base of the body indicates the direction of gas flow.

Once these checks have been completed, if the regulator still fails to perform in a satisfactory manner it should be replaced.

Testing the cooker features

- Observe the flame appearance on each burner. If it is much smaller or larger than expected, then the injector size needs checking.

NOTE: When flame is unsatisfactory, then refer to the Electrolux Technical Publications and correct the fault, if possible.

When maximum flame appearance is correct, then check the turn-down setting on each burner. If the settings appear to be incorrect, proceed as follows:

1. Adjust the bypass screw mounted on the body of each hotplate control. This is accessible when the control knob and the control panel are removed.
2. Check the ignition on all burners both separately and in combination.
3. Check the operation of the electrical components, if applicable.
4. If you are satisfied that the cooker is operating correctly, then turn it off and show the customer how to use it. Make sure you ask the customer to operate the clock and controls.

NOTE: If the cooker cannot be adjusted to perform correctly, then inform the customer of the problem and put a warning notice on the cooker. If the problem is dangerous, then disconnect the cooker. If there is a fault, then the customer should be advised to contact the manufacturer's local service organisation or the retailer.



FOR SALES IN AUSTRALIA AND NEW ZEALAND
APPLIANCE: BUILT-IN OVEN, COOKTOP
AND FREESTANDING COOKERS

This document sets out the terms and conditions of the product warranties for Electrolux Appliances. It is an important document. Please keep it with your proof of purchase documents in a safe place for future reference should you require service for your Appliance.

1. In this warranty:
 - (a) 'acceptable quality' as referred to in clause 10 of this warranty has the same meaning referred to in the ACL;
 - (b) 'ACL' means Schedule 2 to the Competition and Consumer Act 2010;
 - (c) 'Appliance' means any Electrolux product purchased by you and accompanied by this document;
 - (d) 'ASC' means Electrolux authorised service centres;
 - (e) 'Electrolux' means Electrolux Home Products Pty Ltd of 163 O'Riordan Street, Mascot NSW 2020, ABN 51 004 762 341 in respect of Appliances purchased in Australia and Electrolux (NZ) Limited (collectively 'Electrolux') of 3-5 Niall Burgess Road, Mount Wellington, in respect of Appliances purchased in New Zealand;
 - (f) 'major failure' as referred to in clause 10 of this warranty has the same meaning referred to in the ACL and includes a situation when an Appliance cannot be repaired or it is uneconomic for Electrolux, at its discretion, to repair an Appliance during the Warranty Period;
 - (g) 'Warranty Period' means the Appliance is warranted against manufacturing defects in Australia for 24 months and in New Zealand for 24 months, following the date of original purchase of the Appliance;
 - (h) 'you' means the purchaser of the Appliance not having purchased the Appliance for re-sale, and 'your' has a corresponding meaning.
2. This warranty only applies to Appliances purchased and used in Australia or New Zealand and used in normal domestic applications and is in addition to (and does not exclude, restrict, or modify in any way) any non-excludable statutory warranties in Australia or New Zealand.
3. During the Warranty Period Electrolux or its ASC will, at no extra charge if your Appliance is readily accessible for service, without special equipment and subject to these terms and conditions, repair or replace any parts which it considers to be defective. Electrolux or its ASC may use remanufactured parts to repair your Appliance. You agree that any replaced Appliances or parts become the property of Electrolux. This warranty does not apply to light globes, batteries, filters or similar perishable parts.
4. Parts and Appliances not supplied by Electrolux are not covered by this warranty.
5. To the extent permitted by law, you will bear the cost of transportation, travel and delivery of the Appliance to and from Electrolux or its ASC. If you reside outside of the service area, you will bear the cost of:
 - (a) travel of an authorised representative;
 - (b) transportation and delivery of the Appliance to and from Electrolux or its ASC.

In all instances, unless the Appliance is transported by Electrolux or an Electrolux authorised representative, the Appliance is transported at the owner's cost and risk while in transit to and from Electrolux or its ASC.
6. Proof of purchase is required before you can make a claim under this warranty.
7. You may not make a claim under this warranty unless the defect claimed is due to faulty or defective parts or workmanship. Electrolux is not liable in the following situations (which are not exhaustive):
 - (a) the Appliance is damaged by:
 - (i) accident
 - (ii) misuse or abuse, including failure to properly maintain or service
 - (iii) normal wear and tear
 - (iv) power surges, electrical storm damage or incorrect power supply
 - (v) incomplete or improper installation
 - (vi) incorrect, improper or inappropriate operation
 - (vii) insect or vermin infestation
 - (viii) failure to comply with any additional instructions supplied with the Appliance;
 - (b) the Appliance is modified without authority from Electrolux in writing;
 - (c) the Appliance's serial number or warranty seal has been removed or defaced;
 - (d) the Appliance was serviced or repaired by anyone other than Electrolux, an authorised repairer or ASC.
8. This warranty, the contract to which it relates and the relationship between you and Electrolux are governed by the law applicable where the Appliance was purchased. Where the Appliance was purchased in New Zealand for commercial purposes the Consumer Guarantee Act does not apply.
9. To the extent permitted by law and subject to your non-excludable statutory rights and warranties, Electrolux excludes all warranties and liabilities (other than as contained in this document) including liability for any loss or damage whether direct or indirect arising from your purchase, use or non use of the Appliance.
10. For Appliances and services provided by Electrolux in Australia, the Appliances come with a guarantee by Electrolux that cannot be excluded under the ACL. You are entitled to a replacement or refund for a major failure and for compensation for any other reasonably foreseeable loss or damage. You are also entitled to have the Appliance repaired or replaced if the Appliance fails to be of acceptable quality and the failure does not amount to a major failure. The benefits to you given by this warranty are in addition to your other rights and remedies under a law in relation to the Appliances or services to which the warranty relates.
11. At all times during the Warranty Period, Electrolux shall, at its discretion, determine whether repair, replacement or refund will apply if an Appliance has a valid warranty claim applicable to it.
12. For Appliances and services provided by Electrolux in New Zealand, the Appliances come with a guarantee by Electrolux pursuant to the provisions of the Consumer Guarantees Act, the Sale of Goods Act and the Fair Trading Act.
13. To enquire about claiming under this warranty, please follow these steps:
 - (a) carefully check the operating instructions, user manual and the terms of this warranty;
 - (b) have the model and serial number of the Appliance available;
 - (c) have the proof of purchase (e.g. an invoice) available;
 - (d) telephone the numbers shown below.
14. You accept that if you make a warranty claim, Electrolux and its ASC may exchange information in relation to you to enable Electrolux to meet its obligations under this warranty.

Important Notice

Before calling for service, please ensure that the steps listed in clause 13 above have been followed.

<p>FOR SERVICE or to find the address of your nearest state service centre in Australia PLEASE CALL 13 13 49 For the cost of a local call (Australia only)</p>	<p>SERVICE AUSTRALIA ELECTROLUX HOME PRODUCTS electrolux.com.au</p>	<p>FOR SPARE PARTS or to find the address of your nearest state spare parts centre in Australia PLEASE CALL 13 13 50 For the cost of a local call (Australia only)</p>
<p>FOR SERVICE or to find the address of your nearest authorised service centre in New Zealand FREE CALL 0800 10 66 10 (New Zealand only)</p>	<p>SERVICE NEW ZEALAND ELECTROLUX (NZ) Limited electrolux.co.nz</p>	<p>FOR SPARE PARTS or to find the address of your nearest state spare parts centre in New Zealand FREE CALL 0800 10 66 20 (New Zealand only)</p>

Electrolux Home Products Australia

telephone: 1300 363 640
fax: 1800 350 067
email: customercare@electrolux.com.au
web: electrolux.com.au



Electrolux Home Products New Zealand

telephone: 0800 436 245
fax: 0800 225 088
email: customercare@electrolux.co.nz
web: electrolux.co.nz



To add a touch of professional inspiration to your home, visit electrolux.com.au or electrolux.co.nz

electrolux.com.au



or electrolux.co.nz



P/No. A05603601

ECN: 044443

© 2016 Electrolux Home Products Pty Ltd.

EMAN_90cmFS_May16