

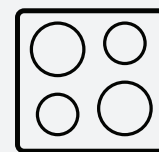

Thinking of you
Electrolux



.....
User manual

.....
Induction Hob

.....
EHI845BA



WE'RE THINKING OF YOU

Thank you for purchasing an Electrolux appliance. You've chosen a product that brings with it decades of professional experience and innovation. Ingenious and stylish, it has been designed with you in mind. So whenever you use it, you can be safe in the knowledge that you'll get great results every time. Welcome to Electrolux.

BEFORE USING YOUR APPLIANCE

Before you use the cooktop, we recommend that you read through the whole user manual which provides the description of the cooktop and its functions. To avoid the risks that are always present when you use an electrical appliance, it is important that the cooktop is installed correctly and that you read the safety instructions carefully to avoid misuse and hazards.

For future reference, please store this booklet in a safe place.

CONDITIONS OF USE

This appliance is intended to be used in household and similar applications such as:

- Staff kitchen areas in shops, offices and other working environments
- Farm houses
- By clients in hotels, motels and other residential type environments
- Bed and breakfast type environments

BEFORE YOU CALL

Please ensure you read the instruction manual fully before you call for service, or a full service fee could be applicable.

RECORD MODEL AND SERIAL NUMBER HERE:

Model: _____

Serial No: _____

CONTENTS

3	Safety information
5	Product description
6	Operating instructions
10	Helpful hints and tips
12	Care and cleaning
12	Troubleshooting
14	Installation
15	Technical information
15	Environment concerns
17	Warranty

LEGEND



This symbol indicates information concerning your personal safety.



This symbol indicates information on how to avoid damaging the cooktop.



This symbol indicates tips and information about use of the cooktop.





This symbol indicates tips and information about economical and ecological use of the cooktop.

SAFETY INFORMATION

Please read the user manual carefully and store in a handy place for later reference. Pass the user manual on to possible new owners of the cooktop.



Read the following carefully to avoid damage or injury.

-  **This symbol indicates never to do this**
-  **This symbol indicates always do this**

Children and vulnerable people safety

WARNING!







Risk of suffocation, injury or permanent disability.





-  Do not let persons, children included, with reduced physical sensory, reduced mental functions or lack of experience and knowledge use the appliance. They must have supervision or instruction for the operation of the appliance by a person who is responsible for their safety.
-  Do not let children play with the appliance.
-  Keep all packaging away from children.
-  Keep children and pets away from the appliance when it operates or when it cools down. Accessible parts are hot.
-  If the appliance has a child safety device, we recommend that you activate it.

Installation

WARNING!

Only a qualified person must install this appliance.











-  Remove all the packaging.
-  Do not install or use a damaged appliance.
-  Obey the installation instruction supplied with the appliance.
-  Keep the minimum distance from the other appliances and units.
-  Always be careful when you move the appliance because it is heavy. Always wear safety gloves.
-  Seal the cut surfaces with a sealant to prevent moisture causing swelling.

-  Protect the bottom of the appliance from steam and moisture.
-  Do not install the appliance adjacent to a door or under a window. This prevents hot cookware to fall from the appliance when the door or the window is opened.
-  If the appliance is installed above drawers make sure that the space, between the bottom of the appliance and the upper drawer, is sufficient for air circulation.
-  Make sure that the ventilation space of 5mm, between the worktop and the front of the below unit, is free. The warranty does not cover damages caused by the lack of an adequate ventilation space.
-  The bottom of the appliance can get hot. We recommend to install a non-combustible separation panel under the appliance to prevent access to the bottom.

Electrical connection

WARNING!

Risk of fire and electrical shock.











-  All electrical connections must be made by a qualified electrician.
-  Before every wiring make sure the main terminal of the appliance is not live.
-  Make sure the appliance is installed correctly. Loose and incorrect plug and socket can make the terminal become too hot.
-  Make sure that a shock protection is installed.
-  Do not let the electricity bonds touch the appliance or hot cookware, when you connect the appliance to the near sockets.
-  Do not let the electricity bonds tangle.
-  Use a strain relief clamp on cable.
-  Use the correct mains cable.
-  Make sure not to cause damage to the mains plug and to the mains cable. Contact the Service Centre or an electrician to change a damaged mains cable.
-  The electrical installation must have an isolation device which lets you disconnect the appliance from the mains at all poles. The isolation device must have a contact opening width of minimum 3mm.
-  Use only correct isolation devices: line protecting cut-outs, fuses (screw type fuses removed from the holder), earth leakage trips and contractors.

SAFETY INFORMATION

Use





WARNING!

Risk of injury, burns or electric shock.

	Use this appliance in a household environment.
	Do not change the specification of this appliance.
	Do not use an external timer or a separate remote-control system to operate the appliance.
	Do not let the appliance stay unattended during operation.
	Do not operate the appliance with wet hands or when it has contact with water.
	Do not put cutlery or saucepan lids on the cooking zones. They can become hot.
	Set the cooking zone to "off" after each use. Do not rely on the pan detector.
	Do not use the appliance as a work surface or as a storage surface.
	If there is a crack on the surface, disconnect power supply to prevent the electrical shock.
	Users with a pacemaker must keep a distance of minimum 30cm from the induction cooking zones when the appliance is in operation.









WARNING!

Risk of fire or explosion.

	Fats and oil when heated can release flammable vapours. Keep flames or heated objects away from fats and oils when you cook with them.
	The vapours that very hot oil releases can cause spontaneous combustion.
	Used oil, that can contain food remnants, can cause fire at a lower temperature than oil used for the first time.
	Do not put flammable products or items that are wet with flammable products in, near or on the appliance.
	Do not try to extinguish a fire with water. Disconnect the appliance and cover the flame with a lid or a fire blanket.

WARNING!



Risk of damage to the appliance.

	The glass ceramic can be damaged by objects falling onto it.
	The edge of the glass ceramic can be damaged by being knocked by the cookware.
	Cookware made of cast iron, cast aluminium or with damaged bottoms can scratch the glass ceramic if pushed across the surface.
	Before spillage can become burnt on to the cooking surface, remove it with a damp cloth.
	To avoid damaging cookware and glass ceramics, do not allow saucepans or frying pans to boil dry.
	Do not use the cooking zones with empty cookware or without cookware.
	Do not let cookware boil dry to prevent damage to cookware and the ceramic glass.
	Do not cover the parts of the appliance with aluminium foil.
	Please note: Damage including broken glass or scratches caused by misuse outlined above is not covered under warranty.

Care and cleaning

WARNING!

Risk of damage to the appliance.

	Regularly clean the appliance to prevent the deterioration of the surface material.
	Do not use water spray and steam to clean the appliance.
	Clean the appliance with a moist soft cloth. Only use neutral detergents. Do not use abrasive products, abrasive cleaning pads, solvents or metal objects.

Disposal

WARNING!

Risk of injury or suffocation.

	Disconnect the appliance from the mains supply.
	Cut off the mains cable and discard it.

PRODUCT DESCRIPTION

General overview

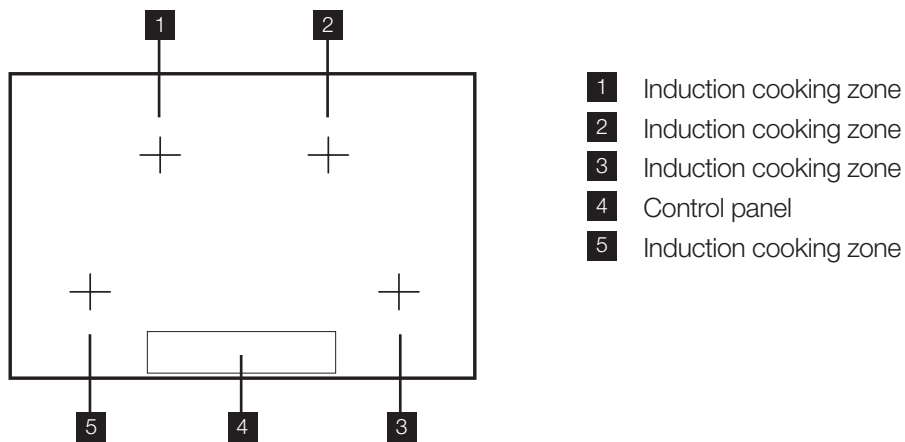



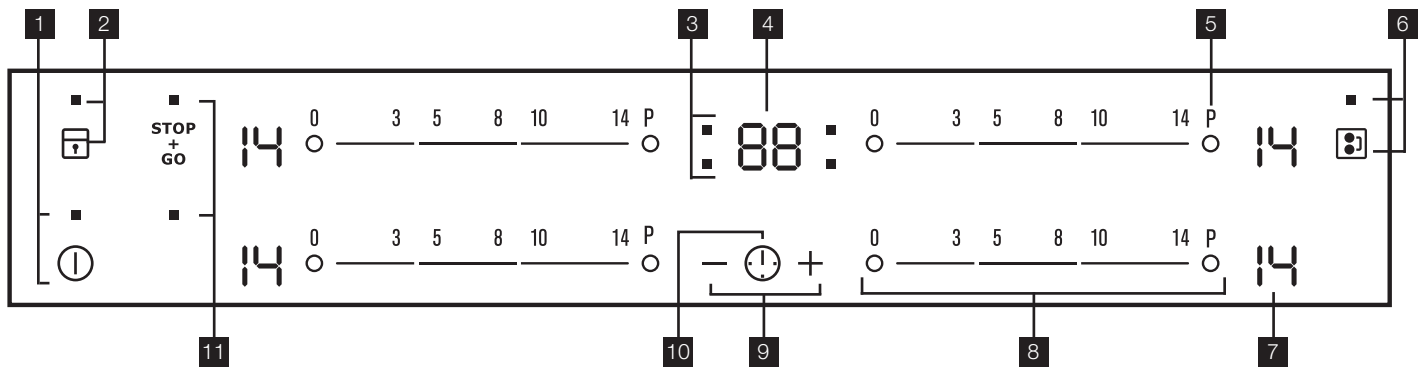







Control panel layout

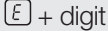
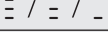

	Sensor field	Function
1	①	To activate and deactivate the appliance
2	🔒	To lock / unlock the control panel
3	Timer indicators of cooking zones	To show for which cooking zone you set the time
4	The timer display	To show the time in minutes
5	P	To activate the Power function
6	🔗	To activate the Connect function
7	A heat setting display	To show the heat setting
8	Control bar	To set a heat setting
9	+ / -	To increase or decrease the time
10	⓪	To set a cooking zone
11	STOP + GO	Sets all operating zones to a keep warm setting

PRODUCT DESCRIPTION

Heat setting displays

Display	Description
	The cooking zone is deactivated
	The cooking zone operates
	The ^{STOP}  function operates
	The automatic heat up function operates
	Power function operates
	There is a malfunction
	OptiHeat Control (3 step Residual heat indicator) : continue cook / stay warm / residual heat
	Lock / The child safety function operates
	Not correct cookware or too small or no cookware on the cooking zone
	The automatic switch off function operates

OptiHeat control (3 step residual heat indicator)



WARNING!

≡ / = / - Risk of burns from residual heat!

OptiHeat Control shows the level of the residual heat. The induction cooking zones make the heat necessary for cooking directly in the bottom of the cookware. The glass ceramic is hot from the heat of the cookware.



OPERATING INSTRUCTIONS

On and off









Touch  for 1 second to activate or deactivate the appliance.

Automatic switch off

The function deactivates the appliance automatically if:

- All cooking zones are deactivated (.
- You do not set the heat setting after you activate the appliance.
- You spill something or put something on the control panel for more than 10 seconds, (a pan, a cloth, etc). An acoustic signal sounds after some time and the appliance deactivates. Remove the object or clean the control panel.
- The appliance becomes too hot (e.g. when a saucepan boils dry). Before you use the appliance again, wait for the cooking zone to cool down.
- You use incorrect cookware. The symbol  comes on and the cooking zone deactivates automatically after 2 minutes.
- You do not deactivate a cooking zone or change the heat setting. After some time  comes on and the appliance deactivates. See the table below.

Automatic switch off times

Heat setting	  - 	 - 	 - 	 - 
Stops after	6 hours	5 hours	4 hours	1.5 hours

The heat setting

Touch the control bar at the heat setting. Change to the left or the right, if it is necessary. Do not release before you have a correct heat setting. The display shows the heat setting.

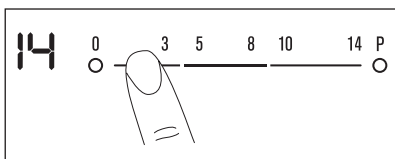

Connect function

IMPORTANT!

Use the Connect Function with the Infinite Plancha accessory¹⁾.

The Connect Function connects two right side cooking zones under the accessory and they operate as one. First set the heat setting for one of the cooking zones.

To activate the Connect Function, touch . To set or change the heat setting, touch one of the control sensors.

To deactivate the Connect Function, touch . The cooking zones operate independently.

¹⁾ The Infinite Plancha accessory is not supplied with the appliance. For more information, please contact your local supplier.

OPERATING INSTRUCTIONS

Automatic heat up

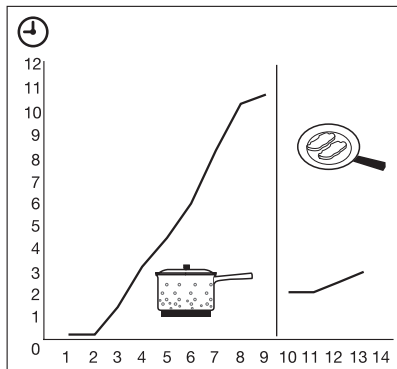

You can get a necessary heat setting in a shorter time if you activate the Automatic Heat Up function. This function sets the highest heat setting for some time (see the graphic), and then decreases to the necessary heat setting. To start the Automatic Heat Up function for a cooking zone:

1. Touch **P** (**P** comes on in the display).
2. Immediately touch the necessary heat setting. After 3 seconds (**P** comes on in the display. To stop the function change the heat setting.

Switching on and off the power function

The Power function makes more power available to the induction cooking zones. The Power function is activated for 5 minutes at most. After that the induction cooking zone automatically switches back to heat setting **14**. To switch on, touch **P**, **P** comes on. To switch off, touch a heat setting between **11** and **14**.

Power management

The power management divides the power between two cooking zones in a pair (see the illustration). The power function increases the power to the maximum level for one cooking zone in the pair. The power in the second cooking zone automatically decreases. The heat setting display for the reduced zone changes between two levels.

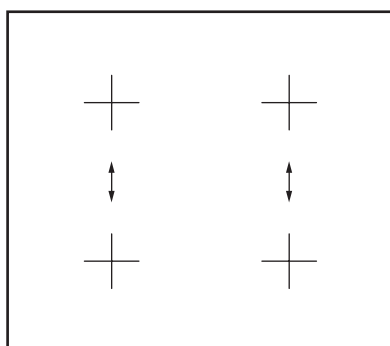

Count down timer

Use the Count Down Timer to set how long the cooking zone operates for one cooking session. **Set the Count Down Timer after the selection of the cooking zone.** You can set the heat setting before or after you set the timer.

- To set the cooking zone: touch **⏸** again and again until the indicator of the required cooking zone comes on.
- Starting the Count Down Timer: touch **+** of the timer to set the time (**00** - **99** minutes). When the indicator of the cooking zone flashes slower, the time counts down.
- Checking the remaining time: select the cooking zone with **⏸**. The indicator of the cooking zone flashes faster. Display shows the remaining time.
- Changing the Count Down Timer: select the cooking zone with **⏸** touch **+** or **-**.
- Stopping the timer: select the cooking zone with **⏸**. Touch **-**. The remaining time counts backwards to **00**. The indicator of the cooking zone goes out. To switch off you can also touch **+** and **-** at the same time.

When the time elapses, the sound operates and **00** flashes. The cooking zone switches off.

- Stopping the sound: touch **⏸**.

Count up timer

Use the Count up Timer to monitor how long the cooking zone operates.

- Selection of the cooking zone (if more than 1 cooking zone operates): touch **⏸** again and again until the indicator of a necessary cooking zone comes on.
- Starting the Count up Timer: touch **-** of the timer **UP** comes on. When the indicator of the cooking zone flashes slower, the time counts up, display switches between **UP** and time elapsed (minutes).
- Checking the elapsed time: select the cooking zone with **⏸**. The indicator of the cooking zone flashes faster. Display shows the elapsed time.
- Stopping the Count up Timer: select the cooking zone with **⏸** and touch **+** or **-** to switch off the timer. The indicator of the cooking zone goes out.



Minute minder

You can use the timer as a Minute Minder while cooking zones are not operating. Touch **⏸**. Touch **+** or **-** of the timer to select the time. When the time elapses, the sound operates and **00** flashes.



- Stopping the sound: touch **⏸**.

OPERATING INSTRUCTIONS





Stop+go

The  function sets all cooking zones that operate to the lowest heat setting (). When  operates, you cannot change the heat setting.

 does not stop the timer function.

- To activate this function touch .  comes on.
- To deactivate this function touch . The heat setting that you set before comes on.





Lock

When the cooking zones operate, you can lock the control panel, but not . It prevents an accidental change of the heat setting. First set the heat setting. To start this function touch . The symbol  comes on for 4 seconds. The Timer stays on. To stop this function touch . The heat setting that you set before comes on. When you stop the appliance, you also stop this function.





The child safety device

This function prevents an accidental operation of the hob.





Starting the child safety device:

- Start the hob with . Do not set the heat settings.
- Touch  for 4 seconds. The symbol  comes on.
- Stop the hob with .

Switching off the child safety device:

- Start the hob with . Do not set the heat settings. Touch  for 4 seconds. The symbol  comes on.
- Stop the hob with .





Overriding the child safety device for one cooking session:

- Start the hob with . The symbol  comes on.
- Touch  for 4 seconds. Set the heat setting in less than 10 seconds. You can operate the hob.
- When you stop the hob with , the child safety device operates again.

OffSound Control (deactivation and activation of the sounds)





Deactivation of the sounds

Deactivate the appliance.

Touch  for 3 seconds. The displays come on and goes out. Touch  for 3 seconds.  comes on, the sound is on. Touch ,  comes on, the sound is off. When this function operates, you can hear the sounds only when:

- you touch 
- the Minute Minder comes down
- the Count Down Timer comes down
- you put something on the control panel.

Activation of the sounds

Deactivate the appliance. Touch  for 3 seconds. The displays come on and goes out. Touch  for 3 seconds.  comes on, because the sound is off. Touch ,  comes on. The sound is on.

HELPFUL HINTS AND TIPS

INDUCTION COOKING ZONES

For induction cooking zones a strong electro-magnetic field creates the heat in the cookware very quickly.

Cookware for induction cooking zones

WARNING!

Use the induction cooking zones with correct cookware.

Cookware material:

- correct: cast iron, steel, enamelled steel, stainless steel, the bottom made of multi-layer (with correct mark from a manufacturer).
- not correct: aluminium, copper, brass, glass, ceramic, porcelain.

Cookware is correct for an induction hob if:

- some water boils very quickly on a zone set to the highest heat setting.
- a magnet pulls on to the bottom of the cookware.

THE BOTTOM OF THE COOKWARE

Must be as thick and flat as possible.

Use of the cooking zones

IMPORTANT!

Put the cookware on the cross which is on the surface that you cook. Cover the cross fully. The magnetic part of the bottom of the cookware must be 125mm minimum. Induction cooking zones adapt to the dimension of the bottom of the cookware automatically. You can cook with the large cookware on two cooking zones at the same time.

The noises during operation

If you can hear:

- crack noise: cookware is made of different materials (Sandwich construction).
- whistle sound: you use one or more cooking zones with high power levels and the cookware is made of different materials (Sandwich construction).
- humming: you use high power levels.
- clicking: electric switching occurs.
- hissing, buzzing: the fan operates.

The noises are normal and do not refer to any defects.

If unfamiliar with induction units please first compare the operating sounds of a demonstration model at your retailer before calling service. If a service call is placed and the sounds are normal you will be charged for the visit.

Energy saving

HOW TO SAVE ENERGY

- If it is possible, always put the lids on the cookware.
- Put cookware on a cooking zone before you start it.
- Use the residual heat to keep the food warm or to melt it.

THE COOKING ZONE EFFICIENCY

The cooking zone efficiency is related to the diameter of the cookware. The cookware with a smaller diameter than the minimum receives only a part of the power generated by the cooking zone. For the minimum diameters see the Technical data chapter.

Öko Timer (Eco Timer)



To save energy, the heater of the cooking zone deactivates before the count down timer sounds. The difference in the operation time depends on the heat setting level and the length of the cooking operation.

HELPFUL HINTS AND TIPS

Examples of cooking applications

The relation between the heat setting and the cooking zone consumption of power is not linear. When you increase the heat setting it is not proportional to the increase of the cooking zone consumption of power.

It means that the cooking zone with the medium heat setting uses less than a half of its power.

 The data in the table is for guidance only.

Heat setting	Use to:	Time	Hints	Nominal power consumption
U 1	Keep cooked foods warm	as required	Cover	3%
1-3	Hollandaise sauce, melt: butter, chocolate, gelatine	5 - 25 min	Mix occasionally	3-8%
1-3	Solidify: fluffy omelettes, baked eggs	10 - 40 min	Cook with a lid on	3-8%
3-5	Simmer rice and milk based dishes, heating up ready-cooked meals	25 - 50 min	Add at least twice as much liquid as rice, stir milk dishes part way through	8-13%
5-7	Steam vegetables, fish, meat	20 - 45 min	Add some tablespoons of liquid	13-18%
7-9	Steam potatoes	20 - 60 min	Use max. 1/4 L water for 750 g of potatoes	18-25%
7-9	Cook larger quantities of food, stews and soups	60 - 150 min	Up to 3 L liquid plus ingredients	18-25%
9-12	Gentle fry: escalope, veal cordon bleu, cutlets, rissoles, sausages, liver, roux, eggs, pancakes, doughnuts	as necessary	Turn halfway through	25-45%
12-13	Heavy fry, hash browns, loin steaks, steaks	5 - 15 min	Turn halfway through	45-64%
14	Boil large quantities of water, cook pasta, sear meat (goulash, pot roast), deep fry chips			100%
P	Boil large quantities of water. Power management is activated.			

The Power function is suitable for heating large quantities of water.

Information on acrylamides

Important! According to the newest scientific knowledge, if you brown food (especially food that contains starch), acrylamides can pose a health risk. Thus, we recommend that you cook at the lowest temperatures and do not brown food too much.

CARE AND CLEANING

Clean the appliance after each use.

Always use cookware with clean bottom.



Scratches or dark stains on the glass ceramic have no effect on how the appliance operates.

To remove the dirt

1. **Remove immediately:** melted plastic, plastic foil, and food with sugar. If not, the dirt can cause damage to the appliance. Use a special scraper for the glass. Put the scraper on the glass surface at an acute angle and move the blade on the surface.

Remove after the appliance is sufficiently cool:







limescale rings, water rings, fat, stains, shiny metallic discolourations. Use a special cleaning agent for glass ceramic or stainless steel.

2. Clean the appliance with a moist cloth and some detergent.
3. At the end rub the appliance dry with a clean cloth.

TROUBLESHOOTING

Problem	Possible cause	Remedy
Red rings, limescale or water rings, shiny metallic or other discolouration, scratches/shadows, bubbles or other miscellaneous marks or stains on ceramic glass cooktop surface.	Cooktop surface has not been cleaned correctly. Cleaning/ maintenance of the cooktop surface is not covered under warranty. If a service call is placed to clean the cooktop you will be charged for the visit.	Use a ceramic glass cleaner such as Cerapol.
Pitting of ceramic glass surface.	Spillovers of liquid with high sugar content.	These types of spills must be removed immediately with a special scraper for the glass. If not permanent damage to the cooktop glass can occur which is not covered under warranty.
You cannot activate the appliance or operate it.	<ul style="list-style-type: none"> • You touched 2 or more sensor fields at the same time. • The Stop+Go function operates. • There is water or fat stains on the control panel. 	<p>Activate the appliance again and set the heat setting in less than 10 seconds.</p> <p>Touch only one sensor field.</p> <p>Refer to the chapter "Operating instructions" Clean the control panel.</p>
An acoustic signal sounds and the appliance deactivates. An acoustic signal sounds when the appliance is deactivated.	You put something on one or more sensor fields.	Remove the object from the sensor fields.
The appliance deactivates.	You put something on the sensor field.	Remove the object from the sensor field.
The residual heat indicator does not come on.	The cooking zone is not hot because it operated only for a short time.	If the cooking zone operated sufficiently long to be hot, speak to the service centre.
The Automatic Heat Up function does not operate.	The cooking zone is hot. The highest heat setting is set.	Let the cooking zone become sufficiently cool. The highest heat setting has the same power as the Automatic Heat Up function.
The heat setting changes between two levels.	The Power management is activated.	Refer to "Power management".

TROUBLESHOOTING

The sensor fields become hot.	The cookware is too large or you put it too near to the controls.	Put large cookware on the rear cooking zones if necessary.
There is no signal when you touch the panel sensor fields.	The signals are deactivated.	Activate the signals (refer to "OffSound control").
 comes on	The automatic switch-off operates.	Deactivate the appliance and activate it again.
 comes on	The Child Safety Device or the Lock function operates.	Refer to the chapter "Operating instructions".
 comes on	<ul style="list-style-type: none"> • No cookware on the cooking zone. • Incorrect cookware. • The diameter of the bottom of the cookware is too small for the cooking zone. • The cookware do not cover the cross. 	<p>Put cookware on the cooking zone.</p> <p>Use the correct cookware.</p> <p>Use larger diameter cookware.</p> <p>Cover the cross fully.</p>
 and number comes on	There is an error in the appliance.	Disconnect the appliance from the electrical supply for some time. Disconnect the fuse from the electrical system of the house. Connect it again. If  comes on again, speak to the after sales service.
 comes on	There is an error in the appliance, because either the cookware boils dry or you've used incorrect cookware. Overheating protection for cooking zone operates. The automatic switch-off operates.	Deactivate the appliance. Remove the hot cookware. After approximately 30 seconds, activate the cooking zone again. If the cookware was the problem, the error message goes out of the display, but the residual heat indicator can stay. Let the cookware become sufficiently cool and refer to "Cookware for the induction cooking zone" to see if your cookware is compatible with the appliance.

If you tried the above solutions and cannot repair the problem, speak to your dealer or the customer service centre. Give the data from the rating plate and an error message that comes on.

Make sure you operated the appliance correctly. If not the servicing by a customer service technician or dealer will not be free of charge, also during the warranty period. The instructions about the customer service and conditions of guarantee are in the guarantee booklet.

INSTALLATION

WARNING!

Refer to “Safety information” chapter.

BEFORE INSTALLATION

Before the installation of the appliance, record the information below from the rating plate. The rating plate is on the bottom of the appliance casing.

Model _____

PNC _____

Serial number _____

Built-in appliances

Only use the built-in appliances after you assemble the appliance into correct built-in units and work surfaces that align to the standards.

Connection cable

- The appliance is supplied with the connection cable.
- Replace the damaged mains cable with a special cable (type H05BB-F Tmax 90°C; or higher). Speak to your local Service Centre.

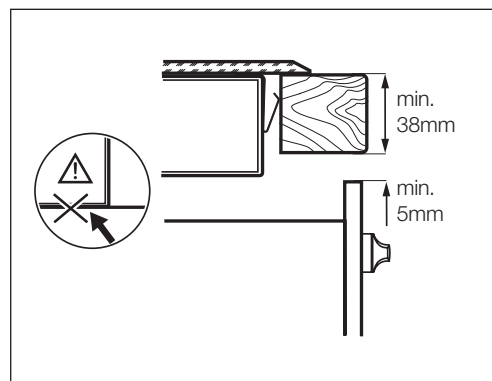
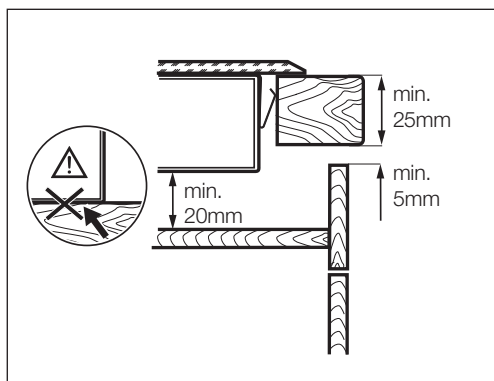
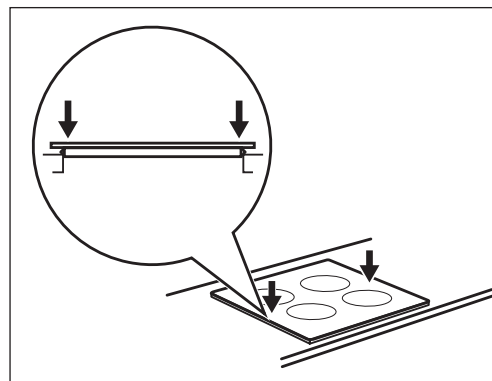
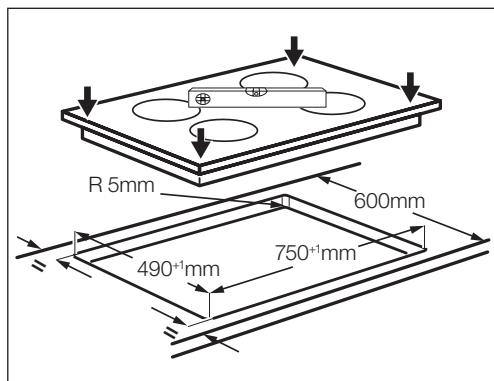
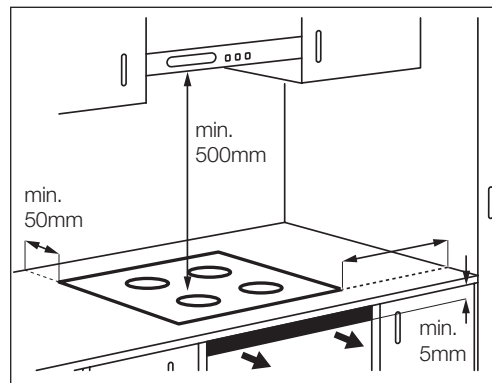
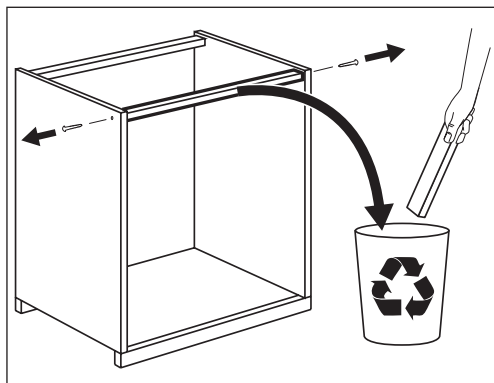

i

If you use a protection box (an additional accessory¹⁾), the front airflow space of 5mm and protective floor directly below the appliance are not necessary.

You can not use the protection box if you install the appliance above an oven.

¹⁾ The protection box accessory may not be available in some countries. Please contact your local supplier.

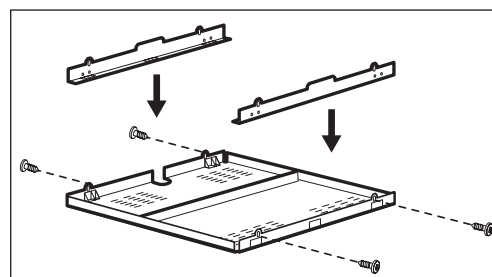

TECHNICAL INFORMATION

Model. EHI845BA
 Typ 58 GBD C3 AU
 Induction 7.4 kW
 Ser.Nr. _____
 ELECTROLUX

Prod.Nr. 305 518 304
 220-240 V 50-60 Hz
 Made in CHINA
 7.4 kW
 CE  

Cooking zone	Nominal Power (Max heat setting) (W)	Power Function activated (W)	Power function maximum duration (min)	Minimum cookware diameter (mm)
Right rear	2300 W	3200 W	10	125
Right front	2300 W	3200 W	10	125
Left rear	2300 W	3200 W	10	125
Left front	2300 W	3200 W	10	125

The power of the cooking zones can be different in some small ranges from the data in the table. It changes with the material and dimensions of the cookware.

ENVIRONMENT CONCERNS

Recycle the materials with the symbol .

Put the packaging in applicable containers to recycle it. Help protect the environment and human health and to recycle waste of electrical and electronic appliances. Do not dispose appliances marked with the symbol  with the household waste. Return the product to your local recycling facility or contact your municipal office.



FOR SALES IN AUSTRALIA AND NEW ZEALAND
 APPLIANCE: BUILT-IN OVEN, COOKTOP
 AND FLOOR MOUNTED COOKER

This document sets out the terms and conditions of the product warranties for Electrolux Appliances. It is an important document. Please keep it with your proof of purchase documents in a safe place for future reference should you require service for your Appliance.

1. In this warranty
 - (a) 'acceptable quality' as referred to in clause 10 of this warranty has the same meaning referred to in the ACL;
 - (b) 'ACL' means Trade Practices Amendment (Australian Consumer Law) Act (No.2) 2010;
 - (c) 'Appliance' means any Electrolux product purchased by you accompanied by this document;
 - (d) 'ASC' means Electrolux' authorised service centres;
 - (e) 'Electrolux' means Electrolux Home Products Pty Ltd of 163 O'Riordan Street, Mascot, NSW 2020, ABN 51 004 762 341 in respect of Appliances purchased in Australia and Electrolux (NZ) Limited of 3-5 Niall Burgess Road, Mount Wellington, in respect of Appliances purchased in New Zealand;
 - (f) 'major failure' as referred to in clause 10 of this warranty has the same meaning referred to in the ACL and includes a situation when an Appliance cannot be repaired or it is uneconomic for Electrolux, at its discretion, to repair an Appliance during the Warranty Period;
 - (g) 'Warranty Period' means:
 - (i) where the Appliance is used for personal, domestic or household use (i.e. normal single family use) as set out in the instruction manual, the Appliance is warranted against manufacturing defects in Australia for 24 months and in New Zealand for 24 months, following the date of original purchase of the Appliance;
 - (ii) where the Appliance is used for commercial purposes (including being used to directly assist a business or where the Appliance is used in a multi-family communal or share type environment), the Appliance will then be warranted against manufacturing defects in Australia for 3 months and in New Zealand for 3 months, following the date of original purchase of the Appliance.
 - (h) 'you' means the purchaser of the Appliance not having purchased the Appliance for re-sale, and 'your' has a corresponding meaning.
2. This warranty only applies to Appliances purchased and used in Australia or New Zealand and is in addition to (and does not exclude, restrict, or modify in any way) any non-excludable statutory warranties in Australia or New Zealand.
3. During the Warranty Period Electrolux or its ASC will, at no extra charge if your Appliance is readily accessible for service, without special equipment and subject to these terms and conditions, repair or replace any parts which it considers to be defective. Electrolux or its ASC may use remanufactured parts to repair your Appliance. You agree that any replaced Appliances or parts become the property of Electrolux. This warranty does not apply to light globes, batteries, filters or similar perishable parts.
4. Parts and Appliances not supplied by Electrolux are not covered by this warranty.
5. You will bear the cost of transportation, travel and delivery of the Appliance to and from Electrolux or its ASC. If you reside outside of the service area, you will bear the cost of:
 - (a) travel of an authorised representative;
 - (b) transportation and delivery of the Appliance to and from Electrolux or its ASC,

In all instances, unless the Appliance is transported by Electrolux or an Electrolux authorised representative, the Appliance is transported at the owner's cost and risk while in transit to and from Electrolux or its ASC.
6. Proof of purchase is required before you can make a claim under this warranty.
7. You may not make a claim under this warranty unless the defect claimed is due to faulty or defective parts or workmanship. Electrolux is not liable in the following situations (which are not exhaustive):
 - (a) the Appliance is damaged by:
 - (i) accident
 - (ii) misuse or abuse, including failure to properly maintain or service
 - (iii) normal wear and tear
 - (iv) power surges, electrical storm damage or incorrect power supply
 - (v) incomplete or improper installation
 - (vi) incorrect, improper or inappropriate operation
 - (vii) insect or vermin infestation
 - (viii) failure to comply with any additional instructions supplied with the Appliance;
 - (b) the Appliance is modified without authority from Electrolux in writing;
 - (c) the Appliance's serial number or warranty seal has been removed or defaced;
 - (d) the Appliance was serviced or repaired by anyone other than Electrolux, an authorised repairer or ASC.
8. This warranty, the contract to which it relates and the relationship between you and Electrolux are governed by the law applicable where the Appliance was purchased. Where the Appliance was purchased in New Zealand for business purposes the Consumer Guarantee Act does not apply.
9. To the extent permitted by law, Electrolux excludes all warranties and liabilities (other than as contained in this document) including liability for any loss or damage whether direct or indirect arising from your purchase, use or non use of the Appliance.
10. For Appliances and services provided by Electrolux in Australia, the Appliances come with a guarantee by Electrolux that cannot be excluded under the Australian Consumer Law. You are entitled to a replacement or refund for a major failure and for compensation for any other reasonably foreseeable loss or damage. You are also entitled to have the Appliance repaired or replaced if the Appliance fails to be of acceptable quality and the failure does not amount to a major failure. The benefits to you given by this warranty are in addition to your other rights and remedies under a law in relation to the Appliances or services to which the warranty relates.
11. At all times during the Warranty Period, Electrolux shall, at its discretion, determine whether repair, replacement or refund will apply if an Appliance has a valid warranty claim applicable to it.
12. For Appliances and services provided by Electrolux in New Zealand, the Appliances come with a guarantee by Electrolux pursuant to the provisions of the Consumer Guarantees Act, the Sale of Goods Act and the Fair Trading Act.
13. To enquire about claiming under this warranty, please follow these steps:
 - (a) carefully check the operating instructions, user manual and the terms of this warranty;
 - (b) have the model and serial number of the Appliance available;
 - (c) have the proof of purchase (e.g. an invoice) available;
 - (d) telephone the numbers shown below.
14. You accept that if you make a warranty claim, Electrolux and its ASC may exchange information in relation to you to enable Electrolux to meet its obligations under this warranty.

Important Notice

Before calling for service, please ensure that the steps listed in point 13 above have been followed.

<p>FOR SERVICE or to find the address of your nearest state service centre in Australia PLEASE CALL 13 13 49 <small>For the cost of a local call (Australia only)</small></p>	<p>SERVICE AUSTRALIA  ELECTROLUX HOME PRODUCTS www.electrolux.com.au</p>	<p>FOR SPARE PARTS or to find the address of your nearest state spare parts centre in Australia PLEASE CALL 13 13 50 <small>For the cost of a local call (Australia only)</small></p>
<p>FOR SERVICE or to find the address of your nearest authorised service centre in New Zealand FREE CALL 0800 10 66 10 <small>(New Zealand only)</small></p>	<p>SERVICE NEW ZEALAND  ELECTROLUX HOME PRODUCTS www.electrolux.co.nz</p>	<p>FOR SPARE PARTS or to find the address of your nearest state spare parts centre in New Zealand FREE CALL 0800 10 66 20 <small>(New Zealand only)</small></p>

Electrolux Home Products Australia

telephone: 1300 363 640
fax: 1800 350 067
email: customercare@electrolux.com.au
web: www.electrolux.com.au

Electrolux Home Products New Zealand

telephone: 0800 234 234
fax: 0800 363 600
email: customercare@electrolux.co.nz
web: www.electrolux.co.nz

The Thoughtful Design Innovator.

Do you remember the last time you opened a gift that made you say "Oh! How did you know? That's exactly what I wanted!" That's the kind of feeling that the designers at Electrolux seek to evoke in everyone who chooses or uses one of our products. We devote time, knowledge, and a great deal of thought to anticipating and creating the kind of appliances that our customers really need and want.

This kind of thoughtful care means innovating with insight. Not design for design's sake, but design for the user's sake. For us, thoughtful design means making appliances easier to use and tasks more enjoyable to perform, freeing our customers to experience that ultimate 21st century luxury, ease of mind. Our aim is to make this ease of mind more available to more people in more parts of their everyday lives, all over the world. So when we say we're thinking of you, you know we mean just that.

The "Thinking of you" promise from Electrolux goes beyond meeting the needs of today's consumers. It also means we're committed to making appliances safe for the environment—now and for future generations.

Electrolux. Thinking of you.

Share more of our thinking at www.electrolux.com.au or www.electrolux.co.nz

P/No. 305518304-A-052013

© 2013 Electrolux Home Products Pty Ltd.
ABN 51 004 762 341

EMAN_IH_EH1845BA_UM_July13