



user manual

Built-In Electric Oven

EOK76030

We were thinking of you
when we made this product

Welcome to the world of Electrolux

Thank you for choosing a first class product from Electrolux, which hopefully will provide you with lots of pleasure in the future. The Electrolux ambition is to offer a wide variety of quality products that make your life more comfortable. You find some examples on the cover in this manual. Please take a few minutes to study this manual so that you can take advantage of the benefits of your new machine. We promise that it will provide a superior User Experience delivering Ease-of-Mind. Good luck!

The following symbols are used in this user manual:



Important information concerning your personal safety and information on how to avoid damaging the appliance.



General information and tips



Environmental information

4 electrolux

Contents

Safety instructions	5	Cleaning and Care	41
Description of the Appliance	8	What to do if ...	44
Before Using for the first time	11	Installation Instructions	45
Using the Oven	13	Disposal	51
Uses, Tables and Tips	30		

Safety instructions

Important safety instructions! Read carefully and keep for future reference!

Electrical safety

- This appliance must only be connected by a **qualified installation engineer**.
- In the event of a fault or damage to the appliance: Take the fuses out or switch off.
- Should the door seal and the door seal surfaces be damaged, the appliance must not be operated until they are repaired.
- **Repairs** to the appliance must only be carried out by **qualified service engineers**. Considerable danger may result from improper repairs. If repairs become necessary, please contact our Customer Care Department or your dealer.

Children's safety

- Small children must be kept away from the appliance. Make sure that children do not touch the appliance when playing.
- Always heat baby food in jars or bottles with the lid or top off. After heating, stir or shake well, so that the heat is equally distributed. Before you give the baby food to the child, **please be sure to test the temperature**.
- When operating the grill (alone or in combination with the microwave) the

viewing window becomes hot. Therefore keep small children away from the door of the appliance.

- Children should be supervised to ensure that they do not play with the appliance.
- The appliance is fitted with a child safety device.

Safety whilst Using

- This appliance is intended to be used for cooking, roasting and baking food in the home.
- Take care when connecting electric appliances to sockets nearby. Do **not** allow connecting leads to come into contact with or to catch beneath the hot oven door.
- **Warning: Risk of burns!** The interior of the oven becomes hot during use.
- Using ingredients containing alcohol in the oven may create an alcohol-air mixture that is easily ignited. In this case, open the door carefully. Do not have embers, sparks or naked flames in the vicinity when opening the door.
- This appliance is not intended for use by persons (including children) with reduced physical, sensory or mental capabilities, or lack of experience and knowledge, unless they have been given supervision or instruction concerning use of the appliance by a person responsible for their safety.



Information on acrylamides
According to the latest scientific knowledge, intensive browning of food, especially in products containing starch, can constitute a health risk due to acrylamides. Therefore we recommend cooking at the lowest possible temperatures and not browning foods too much.

Microwave

- Only switch the appliance on when there is food inside it. With no food in it, the appliance could be overloaded.
- Only use **microwave safe** cookware (see section Uses, Tables and Tips: Suitable Cookware and Materials)
- To protect the interior or the door of the appliance from corrosion through escaping steam (condensed water), please dry the appliance thoroughly with a cloth after each use.
- Do not leave the appliance unattended, if food is being heated or cooked in disposable containers made of plastic, paper or other flammable materials.
- If smoke appears, keep the appliance closed. Switch off the appliance and disconnect from the power supply. Do not use the appliance under any circumstances, if it is no longer working correctly.
- When heating liquids always put a coffee spoon or a glass rod in the container to avoid boiling delay. With boiling delay the boiling temperature is

reached without the typical steam bubbles rising.

If the container is shaken even slightly the liquid can suddenly boil over or spray violently. **Risk of burns!**

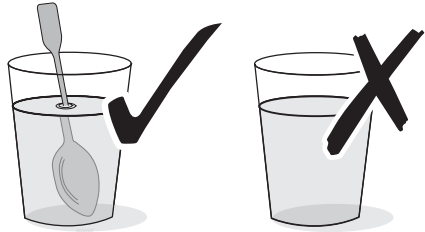

- Prick food with “skin” or “peel”, such as potatoes, tomatoes, sausages, with a fork several times before cooking so that the food does not burst.

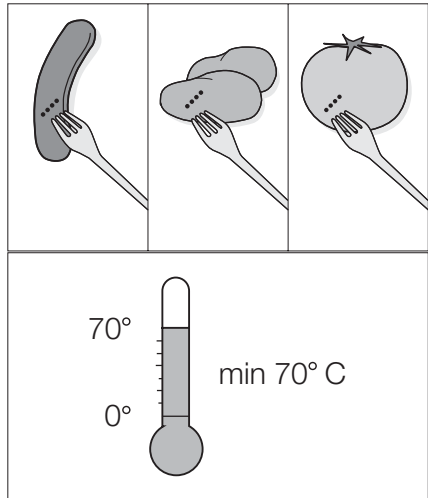

- Ensure that a minimum temperature of **70°C** is reached when cooking/heating food. For this please refer to the power and time data in the tables. Never use mercury or liquid thermometers to measure the temperature of the food.
- Foods heated with microwaves give off heat to the cookware. **Use oven gloves or something similar.**
- Do not overcook the dishes by using powers and times that are too high. The food can dry out, burn or set itself alight in certain places.
- The interior of the oven, the grill heating element and the accessories become hot when the appliance is operating. Please be careful when handling them and use oven gloves or similar for this reason. **Risk of burns!**
- Metal objects must be at least 2 cm from the walls of the oven interior and the oven door. Otherwise spark discharges may be caused and the appliance can be damaged.
- If not advised otherwise, do not use aluminium foil.
- Do not get anything caught between the door and the door frame.
- Always keep the door seal, the door seal surfaces and the interior clean. Lack of cleanliness in the appliance can lead to dangerous situations.
- Do not store any flammable materials inside the oven. These could ignite when the oven is switched on.

How to avoid damage to the appliance

- Do not line the oven with aluminium foil and do not place baking trays, pots, etc. on the oven floor, as the heat that builds up will damage the oven enamel.
- Fruit juices dripping from the baking tray will leave stains, which you will not be able to remove. For very moist cakes, use a deep tray.
- Do not put any strain on the oven door when open.
- Never pour water directly into the oven when it is hot. This could cause damage to or discoloration of the enamel.
- Rough handling, especially around the edges of the front panel, can cause the glass to break.
- Do not store any flammable materials inside the oven. These could ignite when the oven is switched on.
- Do not store any moist foods inside the oven. This could damage the oven enamel.
- After switching off the cooling fan, do not keep uncovered dishes in the oven. Moisture may condense in the oven interior or on the glass doors and may get into the units.

8 electrolux description of the appliance



Note on enamel coating

Changes in the colour of the oven's enamel coating as a result of use do not affect the appliance's suitability for normal and correct use. They therefore do not constitute a defect in the sense of the warranty law.

Do not use the appliance...

- ... for cooking eggs in their shells (with fried eggs, pierce the yolks first) and snails, as it causes these items to burst.
- ... for heating large amounts of cooking oil (fondue, deep frying) and drinks with high alcohol content: **Spontaneous ignition! Risk of explosion!**
- ... for heating tightly closed containers, e.g. tins, bottles, screw top jars.
- ... for drying animals, textiles, grain pillows and gel cushions and other flammable materials: **Risk of fire!**
- ... for cookware made of porcelain, ceramic or earthenware that has small holes, e.g. on handles or unglazed bottoms. Moisture penetrating holes can cause the cookware to crack when it is heated.

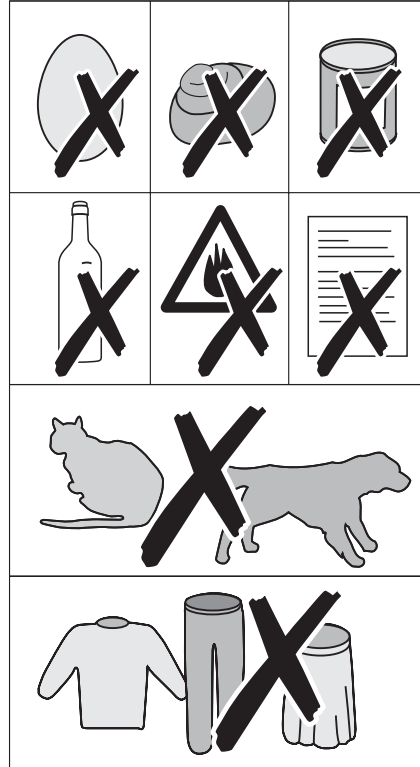

Description of the Appliance

General Overview

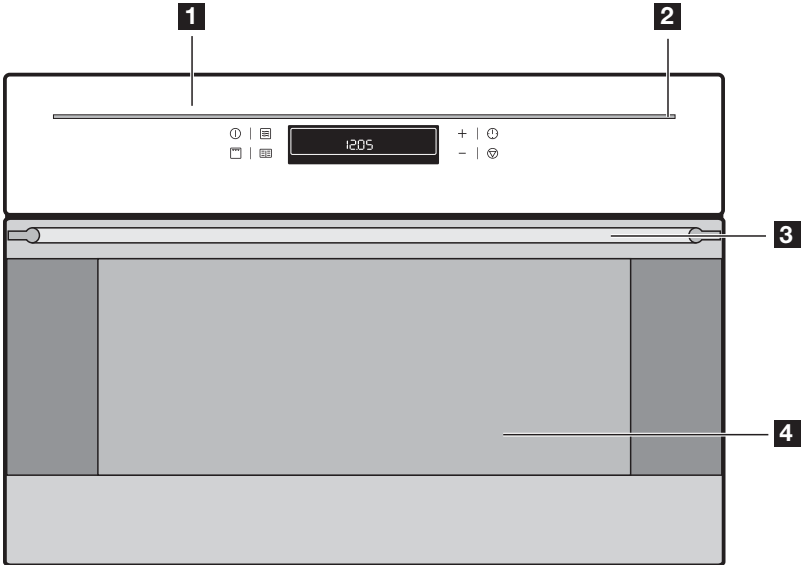

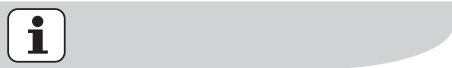

- 1 Control panel
- 2 Light bar
- 3 Door handle
- 4 Oven door



If no function is selected and nothing is changed on the appliance, the

appliance switches itself off after 2 minutes, but the light bar remains on.

To switch the light bar off, switch the appliance on using the Start  button and switch it off again using the Stop  button (press twice).

Control Panel

10 electrolux **description of the appliance**

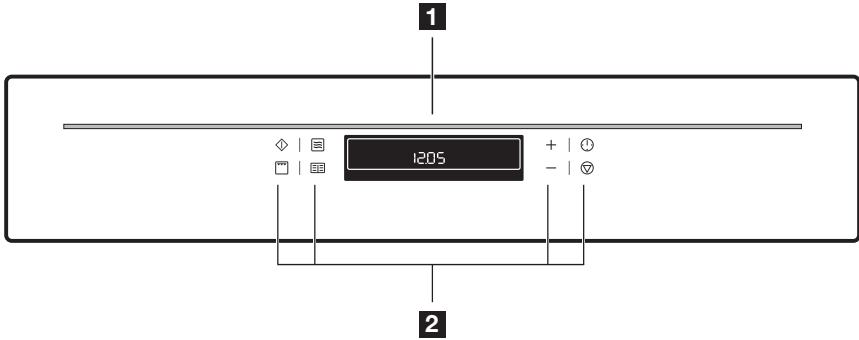

- 1** Oven display
- 2** Function buttons Oven

Oven Features

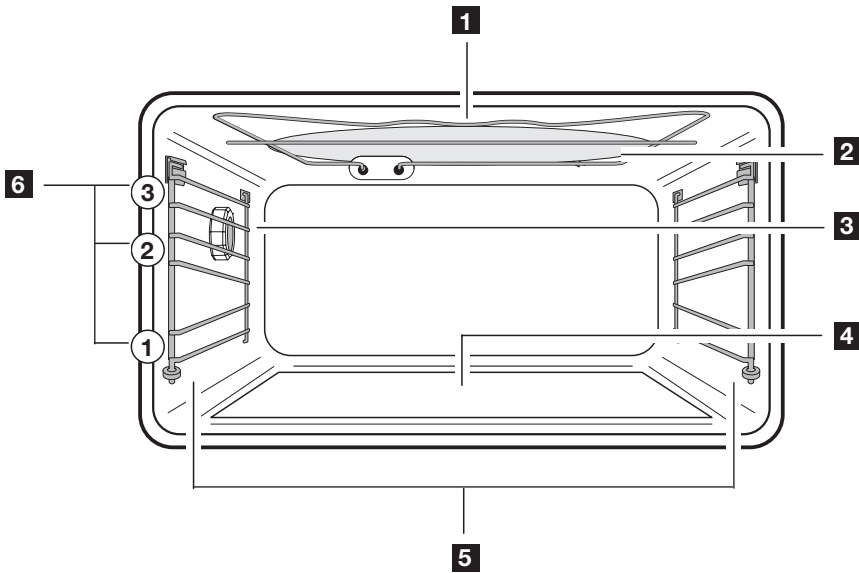

- 1** Grill heating element
- 2** Microwave generator
- 3** Oven lighting
- 4** Glass floor, removable
- 5** Oven shelf runners, removable
- 6** Shelf positions

Oven accessories

Oven shelf

For cookware, cake tins, roasts and grilled foods.

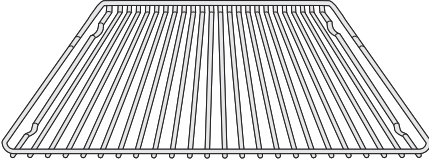

Crunch plate

(non scratch and cut resistant)



Before Using for the first time

Setting and changing the time



The oven only operates when the time has been set.

When the appliance has been connected to the electrical supply or when there has been a power cut, the symbol for Time ⌚ automatically flashes.



1. To change a time of day that has already been set, press the Clock

Functions ⌚ button repeatedly until the symbol for Time ⌚ flashes.

2. Using the + or - button, set the current time.

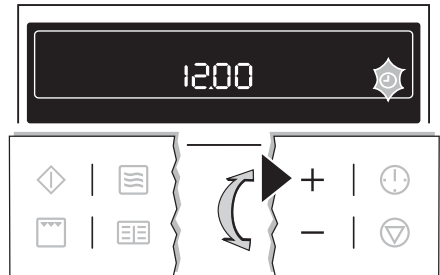



After about 5 seconds, the flashing stops and the clock displays the time of day set.

12 electrolux **before using for the first time**



The appliance is now ready to use.



The time can only be modified, if the child safety device is deactivated, none of the clock functions Countdown , Cook time  or End time  nor any oven functions are set.

Initial cleaning

Clean the oven before using it for the first time.



Do not use caustic or abrasive cleaning agents! These can damage the oven surfaces.



For the metal surfaces, use commercially available cleaning agents.



1. Open the oven door.
The oven light is lit.

2. Remove all oven accessories, and clean them with warm water and a scouring agent.
3. Wash the oven in the same way, and wipe dry.
4. Wipe the front of the appliance with a damp cloth.

Getting to know the appliance



The appliance can be operated in test mode for testing or performing all operating steps. The oven does not heat up.

Switching test mode on

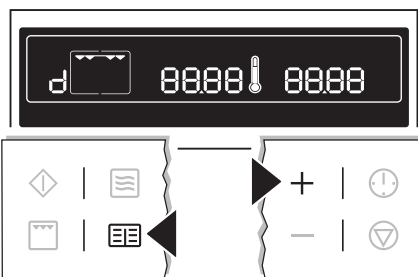
1. **Switch off** the appliance using the Stop  button.
2. Press and hold Baking/Roasting Programmes  and buttons at the same time until an acoustic signal sounds and “d” lights up in the display.



Switching test mode off

1. **Switch off** the appliance using the Stop  button.
2. Press and hold Baking/Roasting Programmes  and buttons at the same time, until a signal sounds and “d” goes out in the display.

Using the Oven

The Electronic Oven Control

The display field

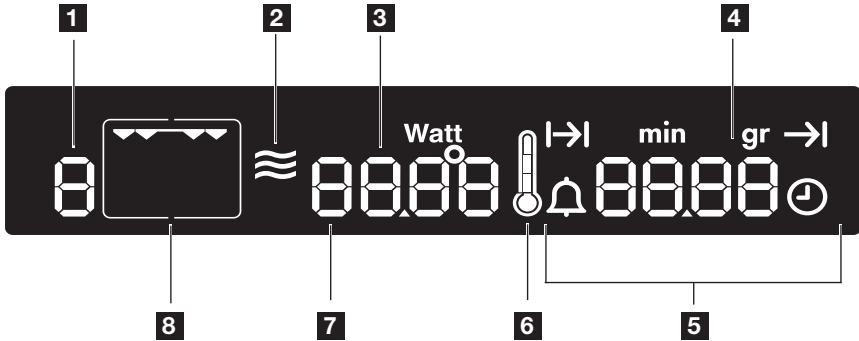

- 1** Memory: P / Test: d
- 2** Microwave function
- 3** Temperature/Time/Microwave Power
- 4** Weight display

- 5** Clock functions Period of operation
 - 6** Thermometer symbol
 - 7** Baking/roasting programmes
 - 8** Oven Functions
- The control panel**

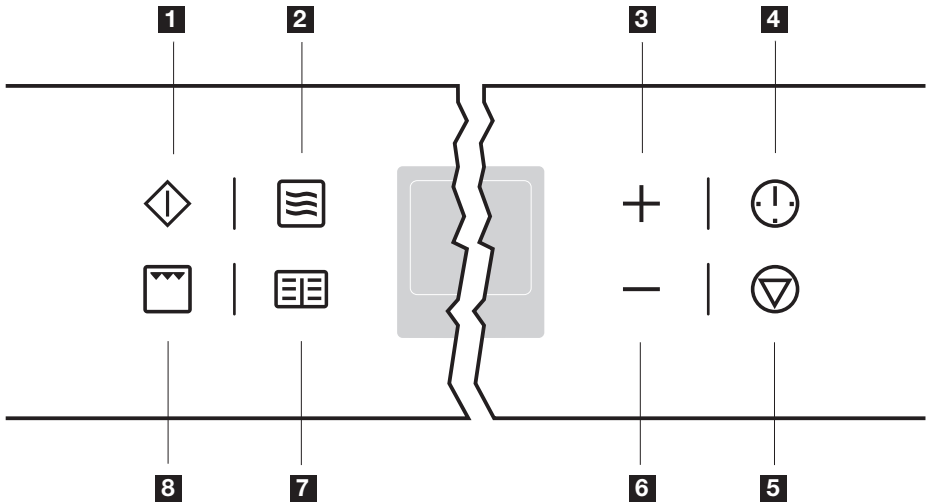

- 1** Start button
- 2** Microwave button
- 3** Button +
- 4** Clock Functions
- 5** Stop button/ Reset
- 6** Button -
- 7** Baking/roasting programmes
- 8** Grill Function button



General instructions

- Always confirm the selected function with the Start button. If the selected function is not started within 120 seconds, the appliance switches itself off.
- When the selected function is started, the oven begins to heat up or the time set begins to count down.

- If the oven door is opened during operation, the function stops. After closing the door continue with the Start button. If the Start button is not pressed within 120 seconds, the appliance switches off.
- The oven light is switched on as long as an oven function is started or the oven door is open. The oven light goes off after 10 minutes when the door is open and the appliance switched off.
- Stop operation with the Stop button, continue with the Start button. Switch the appliance off by pressing the Stop button again.

Switching the oven on

1. Press the grill button. The oven function Grill appears.

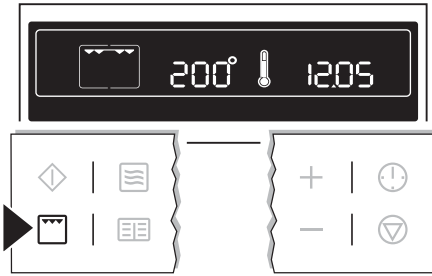

A suggested temperature appears in the temperature display.

2. Press the Start  button to start the oven function Grill  .

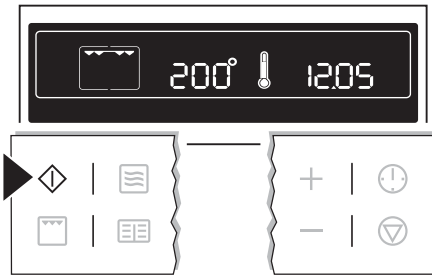

Changing the core temperature

Press the **+** or **-** button to raise or lower the temperature. The setting changes in steps of 5°C.

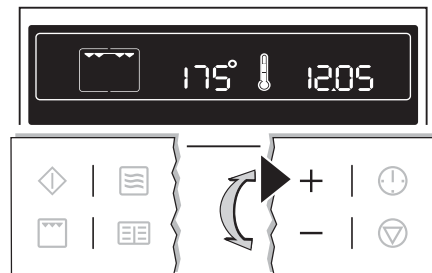

Thermometer symbol

- The slowly rising thermometer symbol  indicates how far the oven has heated up.
- When the selected temperature is reached, an audible signal sounds.

Switching the oven off

To switch the oven off, press the Stop  button repeatedly until only the time and any residual heat is displayed.







Cooling fan

The fan switches on automatically in order to keep the appliance's surfaces cool. When the oven is switched off, the fan continues to run to cool the appliance down, then switches itself off automatically.



Oven Functions

The oven has the following functions:

16 electrolux using the oven



Oven function	Application	Heating element/ fan
 Grill	For grilling flat foodstuffs and for toasting .	Grill
 Microwave	For heating ready meals and drinks, for defrosting meat or fruit and for cooking vegetables and fish.	Microwave generator
Combi Function	For the style of heating for the oven function(s), the function Micro-wave  can be switched on. The dishes are cooked in the shortest time and browned at the same time.	
 Microwave Quick Start	Quick Start of the maximum microwave power when the appliance is switched off using the Start  button. Operating time from 30 seconds to 7 minutes. Each press of the button adds 30 seconds to the operating time displayed.	

Microwave

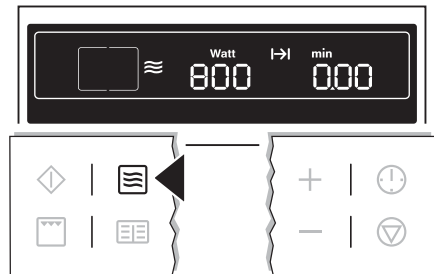
1. If necessary, switch off the appliance using the Stop  button.
2. By repeatedly pressing the Microwave  button, set the desired microwave power.





- The settings options are in 100 Watt steps from 1,000 Watt to 100 Watt.

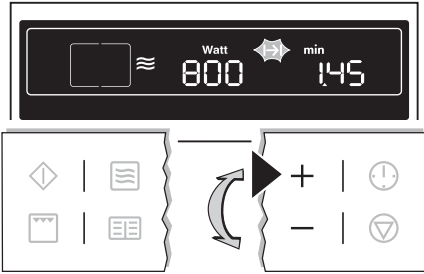

- Repeatedly pressing the Microwave  button makes the power display begin again at 1,000 Watt.
3. Using the + or - button set the desired cook time. The symbol for Cook time  flashes.



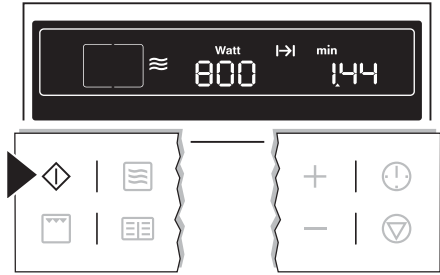

- The cooking times can be set as follows:
 - from 0 to 2 mins. in 5 second steps,
 - from 2 to 5 mins. in 10 second steps,
 - from 5 to 10 mins. in 20 second steps,
 - from 10 to 20 mins. in 30 second steps,
 - from 20 mins. onwards in 1 minute steps.
- The maximum length of operation that can be set is:
 - At 700 Watt to 1,000 Watt 0 to 7 minutes 40 seconds,
 - at 100 Watt to 600 Watt 0 to 59 minutes.

4. When the Start  button is pressed, the time set begins to count down. The symbol for Cook time  lights up.

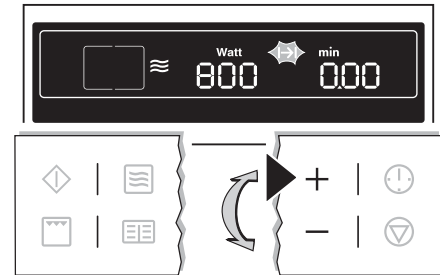

- While the time counts down, the power can be changed using the Microwave  button.
- While the time counts down, using the Clock Functions  and + buttons the cooking time can be increased or - reduced.



When the time has elapsed, an acoustic signal sounds for 2 minutes. The microwave switches itself off. The symbol for Cook time  flashes and the time display appears.

To turn off the acoustic signal: Press any button.



Combi Function

1. If necessary, switch off the appliance using the Stop  button.
2. Press the grill  button. The oven function Grill  appears.

18 electrolux using the oven

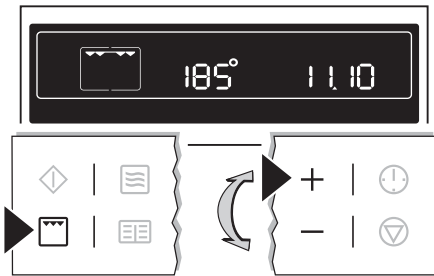
3. Using the **+** or **-** button set the desired temperature.



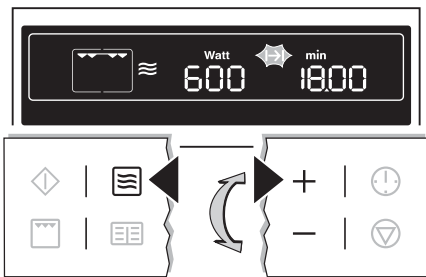

4. By repeatedly pressing the Microwave  button, set the desired microwave power (max. 600 Watt).
5. Using the **+** or **-** button set the desired cook time. The symbol for Cook time  flashes.





- The cooking times can be set as follows:
 - from 0 to 2 mins. in 5 second steps,
 - from 2 to 5 mins. in 10 second steps,
 - from 5 to 10 mins. in 20 second steps,
 - from 10 to 20 mins. in 30 second steps,

- from 20 mins. onwards in 1 minute steps.

The maximum length of operation that can be set is 59 mins.

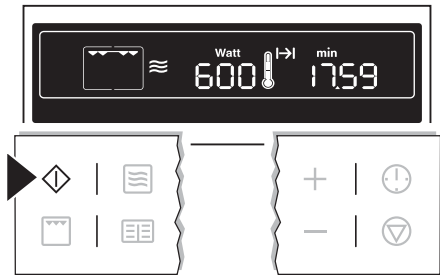
6. When the Start  button is pressed, the time set begins to count down. Oven and microwave are on. The symbol for Cook time  lights up.



- While the time counts down, the power can be changed using the Microwave  button.
- While the time counts down, using the Clock Functions  and **+** buttons the cook time can be increased or **-** reduced.

When the time has elapsed, an acoustic signal sounds for 2 minutes. The appliance switches itself off. The symbol for Cook time  flashes and the time display appears.

To turn off the acoustic signal: Press any button.

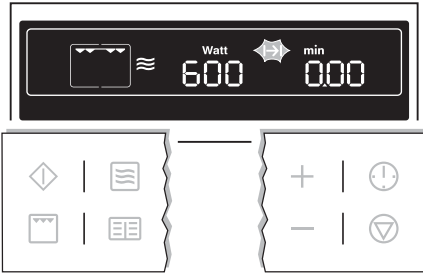

Microwave Quick Start

1. If necessary, switch off the appliance using the Stop (stop sign) button.
2. Press the Start (diamond) button repeatedly until the desired period of operation appears. The appliance switches itself on at maximum microwave power.

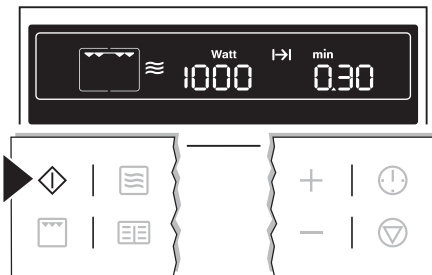

- Each press of the button adds 30 seconds to the period displayed. Maximum of 7 mins. with maximum microwave power.
- While the time counts down, using the Clock Functions (clock) and (+) buttons the cooking time can be increased or — reduced.

buttons the cooking time can be increased or — reduced.

- By repeatedly pressing the Microwave (microwave symbol) button, the microwave power can be changed.
- By pressing the Stop (stop sign) button once, operation can be interrupted. Continue operation using the Start (diamond) button. Pressing the Stop (stop sign) button twice switches the appliance off.

When the time has elapsed, an acoustic signal sounds for 2 minutes. The appliance switches itself off. The symbol for Cook time flashes and the clock display appears.

To turn off the acoustic signal: Press any button.

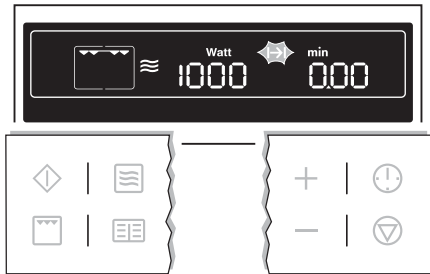

Information on power settings

The overview indicates at which power setting certain processes can be performed. The powers given are guidelines.

Microwave power	Suitable for
1,000 Watt 900 Watt 800 Watt 700 Watt	<ul style="list-style-type: none"> • Heating liquids • Searing at the beginning of a cooking process • Cooking vegetables • Cooking foodstuffs • Melting gelatine and butter
600 Watt 500 Watt	<ul style="list-style-type: none"> • Defrosting and heating frozen meals • Heating one-plate meals • Simmering stews • Cooking egg dishes
400 Watt 300 Watt 200 Watt	<ul style="list-style-type: none"> • Continuing to cook meals • Cooking delicate foodstuffs • Heating baby food • Simmering rice • Heating delicate foods • Melting cheese
100 Watt	<ul style="list-style-type: none"> • Defrosting meat, fish, bread • Defrosting cheese, cream, butter • Defrosting fruit and cakes (gateaux) • Raising yeast dough • Warming up cold dishes and drinks

Inserting the grill



Shelf runner safety and anti-tip device

As a shelf runner safety device, all insertable components have a small curved indentation at the bottom on the right and left-hand edge.

Always insert insertable components so that this indentation is at the back of the oven interior. This indentation is also im-

portant for preventing the insertable components from tipping.

Inserting the grill:

Insert the grill so that the feet point downwards.

Push the grill between the guide bars of the selected oven level.

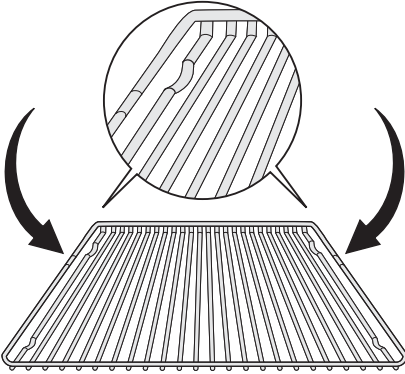



The high rim around the grill is an additional device to prevent cookware from slipping.

Additional functions

Microwave Programmes



For this function, use the pre-set programmes (see chapter Uses, Tables and Tips: Programmes).

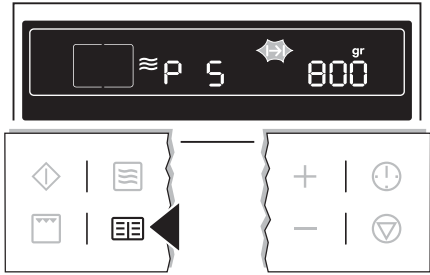

1. If necessary, switch off appliance using the Stop  button.
2. By repeatedly pressing the Recipes  button, select the desired programme (P 1 to P10).

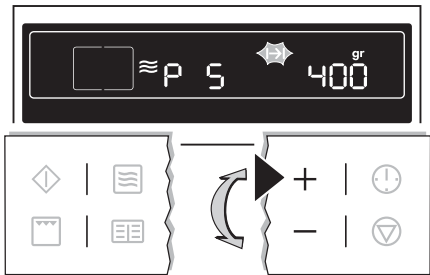

- In the display the preset weight "gr" is displayed. The symbol for Cook time  flashes. **Weight = Cook time**

3. By pressing the **+** or **-** button, the weight display can be adapted to the weight of the food, minimum 100 g, maximum 1,500 g (P 5 to P10 maximum 1,000 g).



- Inputting the weight automatically controls the length of time the microwave operates.
 - Always input the lower weight, e. g. a loaf weighs 460 g: Set the weight to 400 g.
4. When the Start  button is pressed, the time set begins to count down. The symbols for Cook time  and "min" light up.

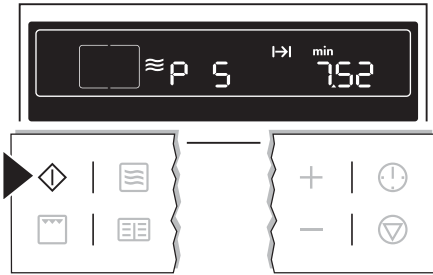

- When the time has elapsed, an acoustic signal sounds for 2 minutes. The oven switches itself off. The symbol for Cook time I-| flashes.



With some programmes, after the time has elapsed a Keep Warm function is started. A signal sounds and in the display “HH” lights up.

After the Keep Warm function has ended, the signal sounds for 2 minutes. The oven switches itself off. The symbol for Cook time I-| flashes and the time display appears.

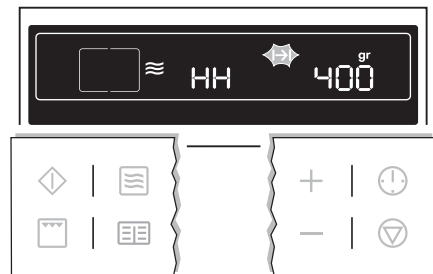

To turn off the acoustic signal: Press any button.

Memory Function

The Memory Function can be used to save **one** setting which is used very frequently.

1. Set oven function, temperature and, if necessary the clock functions Cook time I-| and/or End time ->| or set microwave power and Cook time I-| .
2. Press and hold the Recipes [grid] button for approx. 2 seconds, until an acoustic signal sounds. The setting is saved.

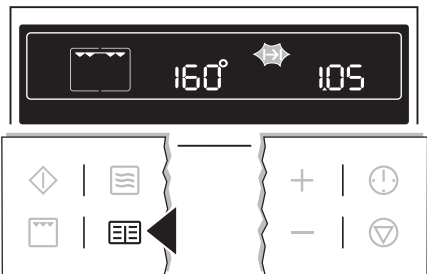

3. Continue by pressing the Start [diamond] button or switch the appliance off using the Stop [inverted triangle] button.

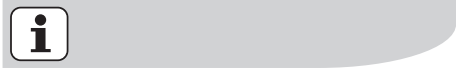

To save another setting, press the Recipes [grid] button again for approx. 2 seconds. The previously saved setting is replaced by the new one.

Starting the Memory Function

1. If necessary, switch off the appliance using the Stop [inverted triangle] button.
2. Using the Recipes [grid] button, call up the saved setting.

3. Press the Start  button.

Clock Functions

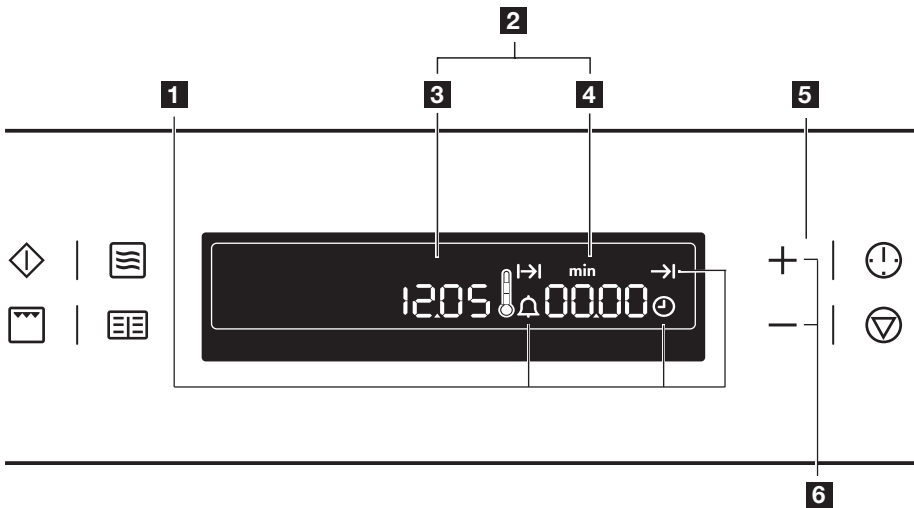
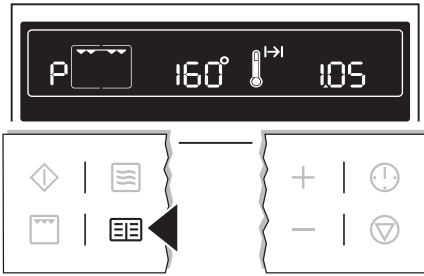

- 1** Clock Functions
- 2** Time display
- 3** Clock
- 4** Cook time/End time/Operating time
- 5** Clock Functions
- 6** Settings buttons

Countdown

To set a countdown. When it has counted down, an audible signal sounds. This function has no effect on the operation of the microwave and oven.

Microwave cook time **min**

For setting how long the oven is to operate.

Cook time

To set how long the oven is to be in use.

End time

To set when the oven is to switch off again.

Time

To set, change or check the time (See also section "Before Using for the First Time").



General instructions

- After a clock function has been selected, the corresponding symbol flashes for about 5 seconds. During this time, the desired times can be set or modified using the + or - button.
- When the desired time has been set, the symbol continues to flash for approx. 5 seconds. After this the symbol lights up. The set Countdown ⏰ begins to count down.
- The time set for Cook time |→| and End time →| begins to count down after the selected function starts.

Countdown ⏰

1. Press the Clock Functions ⌚ button repeatedly until the symbol for Countdown ⏰ flashes.



2. Using the + or - buttons, set the desired countdown (max. 99.00 minutes).

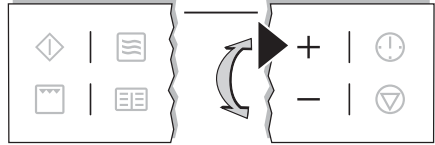

After about 5 seconds the display shows the time remaining. The symbol for Countdown ⏰ lights up.

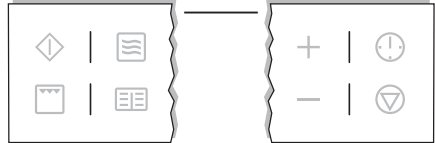

When the time set has elapsed, an acoustic signal sounds for 2 minutes. "0.00" lights up and the symbol for Countdown ⏰ flashes.

To turn off the acoustic signal: Press any button.

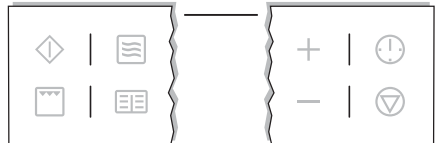

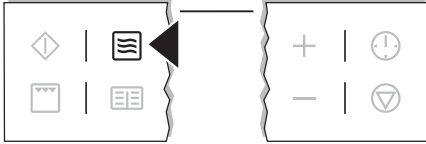
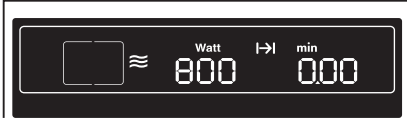

Microwave cook time I→ min

1. Select microwave function and set the power by repeatedly pressing the Microwave  button.



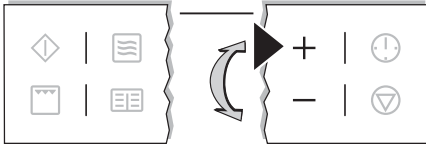

2. Using the + or - button, set the desired cooking time. The symbol for Cook time I→ flashes.

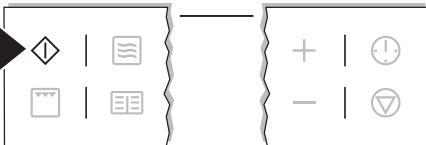
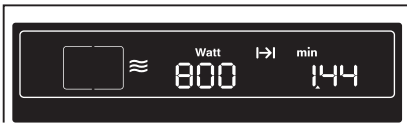

3. When the Start  button is pressed, the time set begins to count down. The symbol for Cook time I→ lights up.



By repeatedly pressing the Clock Functions  button, the current time can be called up. While the time counts down, using the  and + buttons the cook time can be increased or - reduced.

When the time has elapsed, an acoustic signal sounds for 2 minutes. The microwave switches itself off.

"0.00" is displayed and the symbol for Cook time I→ flashes.

To turn off the acoustic signal: Press any button.

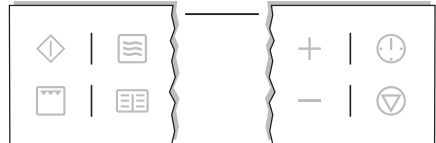
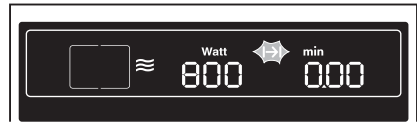

Cook time I→

1. Select oven function and temperature using the + or - button.
2. Press the Clock Functions  button repeatedly until the symbol for Cook time I→ flashes.

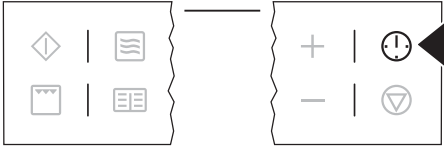

3. Using the + or - button, set the desired cooking time.

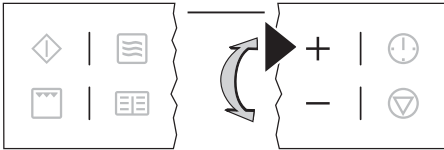

4. When the Start ◊ button is pressed, the time set begins to count down. The symbol for Cook time ⤴⤵ lights up.

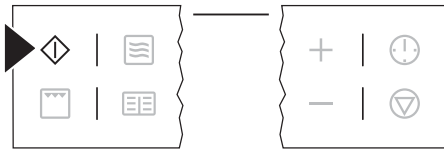
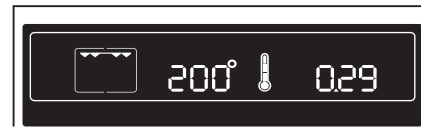

By repeatedly pressing the Clock Functions ⌚ button, the current time can be called up.

When the time has elapsed, an acoustic signal sounds for 2 minutes. The oven switches itself off.

“0.00” is displayed and the symbol for Cook time ⤴⤵ flashes.

To turn off the acoustic signal: Press any button.

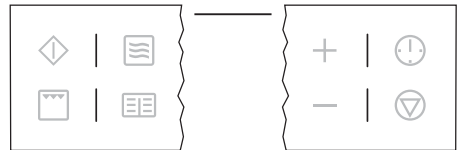

End time →

1. Select oven function and temperature using the + or - button.
2. Press the Clock Functions ⌚ button repeatedly until the symbol for End time → flashes.

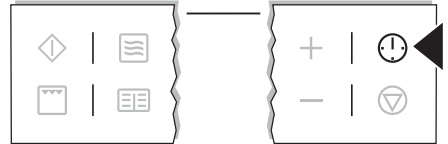

3. Using the + or - button, set the desired switch-off time.

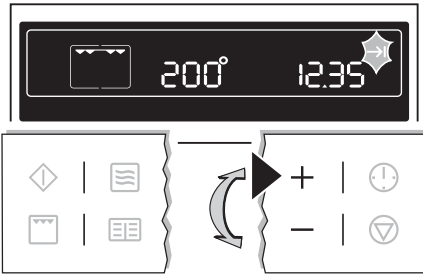

The symbols for End time →| and Cook time |→| light up.
The oven switches itself off automatically.



Cook time |→| and End time →| combined



Cook time |→| and End time →| can be used simultaneously, if the oven is to be switched on and off automatically at a later time.

1. Select oven function and temperature.
2. Using the Cook time |→| function, set the time required for cooking the dish.
e.g. 1 hour.

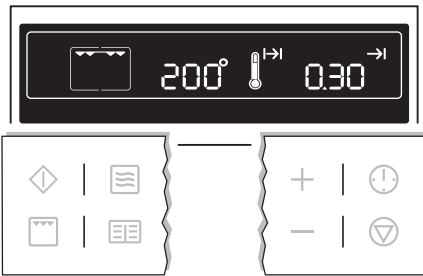

By repeatedly pressing the Clock Functions ⌚ button, the current time can be called up.

When the time has elapsed, an acoustic signal sounds for 2 minutes. The oven switches itself off.
"0.00" is displayed and the symbols for End time →| and Cook time |→| flash.
To turn off the acoustic signal: Press any button.

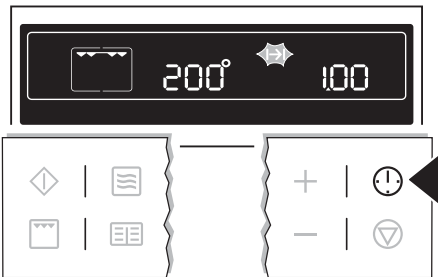

3. Using the End time →| function, set the time at which the dish is to be ready.
e.g. at 14:05.

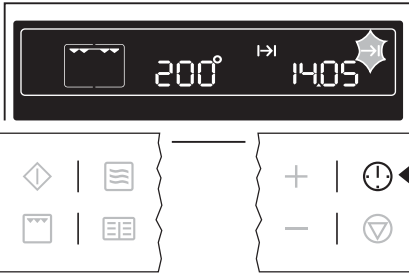

The symbols for Cook time \rightarrow and End time \rightarrow light up.

The oven switches on automatically at the time calculated. e.g. at 13:05.

When the set cooking time has elapsed, an acoustic signal sounds for 2 minutes and the oven switches itself off. e.g. at 14:05.

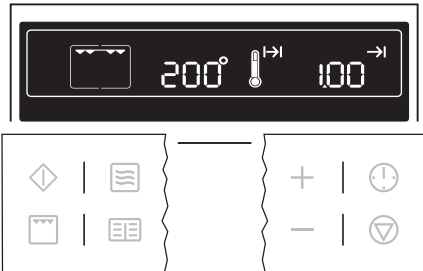

Other functions

Switching off the display



You can save energy by switching off the display.

Switching off the display

1. If necessary, switch off the appliance using the Stop ∇ button. Residual heat must not be displayed.

2. Press buttons Clock Functions ⌚ and $-$ at the same time until the display goes out.



As soon as the appliance is switched on again, the display automatically switches itself on. When the appliance is next switched off, the display goes out again.

To have the time permanently displayed again, you must switch the display on again.

Switching on the display

1. If necessary, switch off the appliance using the Stop ∇ button.
2. Press buttons Clock Functions ⌚ and $-$ at the same time until the display comes on again.

Child safety device

As soon as the child safety device is activated, it is no longer possible to operate the appliance.

Activating the child safety device



1. If necessary, switch off the appliance using the Stop ∇ button. An oven function must not be selected.

2. Press Recipes  and — buttons at the same time until SAFE appears in the display.



The child safety device is now activated.

Deactivating the child safety device

1. If necessary, switch off appliance using the Stop  button.
2. Press Recipes  and — buttons at the same time until SAFE goes out in the display.

The child safety device is now deactivated and the appliance is again ready for use.

Button beep

Switching off button beep

1. If necessary, switch off appliance using the Stop  button.
2. Press and hold + and — buttons at the same time until a signal sounds (approx. 2 seconds).

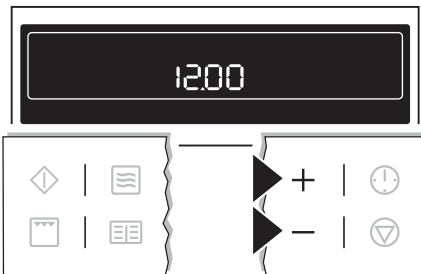

The button beep is now switched off.

Switching on button beep

Press + and — hold and buttons at the same time until a signal sounds (approx. 2 seconds).

The button beep is switched on again.

Oven safety cut-out



If not switched off after a certain time, or if the temperature is not modified, the oven switches off automatically.

The last temperature set flashes in the temperature display.

The oven switches itself off at an oven temperature of:

30 - 120°C after 12.5 hours

120 - 200°C after 8.5 hours

200 - 250°C after 5.5 hours

OFF appears in the display.

Using the appliance after a safety cut-out

Switch the oven off completely. It can then be switched on again.

Uses, Tables and Tips

Grill

Oven function: Grill  with maximum temperature setting



Always grill with the oven door closed.

- For grilling, use both the shelf and the tray together.
- The grilling times are guidelines.
- Grilling is particularly suitable for flat pieces of meat or fish.

Grilling table

Food to be grilled	Oven level	Grilling time	
		1st side	2nd side
Rissoles	3	8-10 mins.	6-8 mins.
Pork fillet	2	10-12 mins.	6-10 mins.
Sausages	3	8-10 mins.	6-8 mins.
Fillet steaks, veal steaks	3	6-7 mins.	5-6 mins.
Fillet of beef, roast beef (approx. 1 kg)	2	10-12 mins.	10-12 mins.
Toast ¹⁾	3	4-6 mins.	3-5 mins.
Toast with topping	2	8-10 mins.	---

1) Use the grill shelf without a tray

Microwave

Information about operation

General

- After switching off the appliance, let the food stand for a few minutes (see Microwave Tables: Standing Time).
- Remove aluminium foil packaging, metal containers, etc. before preparing the food.

Cooking

- If possible, cook food covered with material suitable for use in the microwave. Only cook food uncovered, if a crust is to be kept.
- Chilled or frozen foods require a longer cooking time.
- Dishes containing sauce should be stirred from time to time.
- Vegetables that have a firm structure, such as carrots, peas or cauliflower, should be cooked in water.

- Turn larger pieces about halfway through the cooking time.
- If possible, cut vegetables into similar sized pieces.
- Use flat, wide dishes.

Defrosting meat, poultry, fish

- Place the frozen, unwrapped food on a small upturned plate with a container underneath or on a defrosting rack or plastic sieve so that the defrosting liquid can run off.
- Turn the food after half the defrosting time. If possible, divide, remove pieces that have started to defrost.

Defrosting butter, portions of ga-teau, quark

- Do not defrost completely in the appliance, but leave to defrost at room temperature. This gives a more even result. Remove any metal or aluminium packaging or parts before defrosting completely.



Defrosting fruit, vegetables



- Do not completely defrost fruit and vegetables, which are to be further prepared while still raw, in the appliance, but at room temperature.
- Fruit and vegetables that are to be cooked, can be cooked directly using a higher microwave power, without being defrosted.

Ready Meals

- Ready meals in metal packaging or plastic trays with metal covers may only be defrosted or heated in the microwave if these are expressly designated as suitable for use in the microwave.
- You must follow the manufacturer’s instructions printed on the packaging (e. g. remove metal cover and pierce plastic film).

Suitable cookware and materials

Cookware/Material	Microwave 			Oven Grill 
	Defrosting	Heat-ing	Cook-ing	
Ovenproof glass and porcelain (with no metal components, e. g. Pyrex, heatproof glass)	X	X	X	X
Non-ovenproof glass and porcelain ¹⁾	X	--	--	--
Glass and glass ceramic made of ovenproof/ frostproof material (e. g. g. Arcoflam), grill shelf	X	X	X	X
Ceramic ²⁾ , stoneware ²⁾	X	X	X	--
Plastic heat-resistant to 200°C ³⁾	X	X	X	--
Cardboard, paper	X	--	--	--

Cookware/Material	Microwave 			Oven Grill 
	Defrosting	Heat-ing	Cook-ing	
Clingfilm	X	--	--	--
Roasting film with microwave safe closure ³⁾	X	X	X	--
Roasting dishes made of metal, e.g. enamel, cast iron	--	--	--	X
Baking tins, black lacquer or silicon-coated ³⁾	--	--	--	X
Baking tray	--	--	--	X
Browning cookware, e. g. Crostino or Crunch plate	--	X	X	--
Ready meals in packaging ³⁾	X	X	X	X

1) with no silver, gold, platinum or metal plating/ decorations

2) Without quartz or metal parts, no metallic glaze

3) Please observe the maximum temperatures quoted by the manufacturer.

X is suitable
-- is not suitable



Other things to think about ...

- Foods have different shapes and qualities. They are prepared in different amounts. Therefore the necessary times and powers for defrosting, heating or cooking are all different. As a rough guide: **Double the amount = Almost double the time**
- When heating with the microwave the heat is produced in the food itself. For

this reason all places cannot be heated at the same time. The heated dishes should therefore be stirred or turned, especially in the case of larger amounts of food.

- The **standing time** is given in the tables. Let the food stand, in the appliance or outside it, so that the heat is distributed more evenly.
- You get better results for rice using flat, wide dishes.

Microwave Cooking Table Defrost

Dish	Microwave 				
	Size (g)	Power (Watts)	Cook time (Mins.)	Stand- ing time (Mins.)	Comments
Meat					
Meat generally	500	200	10-12	10-15	Turn halfway through cooking
Steaks	200	200	3-5	5-10	Turn halfway through cooking time, remove de-frosted parts
Mixed minced meat	500	200	10-15	10-15	
Goulash	500	200	10-15	10-15	
Poultry					
Chicken	1000	200	25-30	10-20	Turn halfway through cooking time, cover de-frosted parts with aluminium foil
Chicken breast	100-200	200	3-5	10-15	
Chicken thighs	100-200	200	3-5	10-15	
Duck	2000	200	45-60	20-30	
Fish					
Fish generally	500	100	10-15	15-20	Turn halfway through
Fish fillets	500	100	10-12	15-20	
Sausage					
Sliced sausage	100	100	2-4	20-40	Turn halfway through
Dairy products					
Quark	250	100	10-15	25-30	Remove aluminium parts, turn halfway through
Butter	250	100	3-5	15-20	
Cheese	250	100	3-5	30-60	
Cream	200	100	7-12	20-30	Remove aluminium top, stir half-way through
Cakes/Pastries/Bread					

34 electrolux uses, tables and tips

Dish	Microwave 				Comments
	Size (g)	Power (Watts)	Cook time (Mins.)	Stand- ing time (Mins.)	
Yeast dough	1 piece	100	2-3	15-20	Turn plate halfway through
Cheesecake	1 piece	100	2-4	15-20	
Cake (gâteau)	1 piece	100	1-2	15-20	
Dry cake (e. g. pound cake)	1 piece	100	2-4	15-20	
Fruit flan	1 piece	100	1-2	15-20	
Bread	1000	100	15-20	10-15	Turn halfway through
Sliced bread	500	100	8-12	10-15	
Bread rolls	4 rolls	100	5-8	5-10	
Fruit					
Strawberries	300	100	8-12	10-15	Defrost covered, stir halfway through
Plums, cherries, raspberries, black- currants, apricots	250	100	8-10	10-15	
Melting					
Chocolate / Choco- late coating	150	600	2-3	---	Stir halfway through
Butter	100	200	2-4	---	
Heating					
Baby food in jars	200	300	2-3	---	Stir halfway through Check temperature!
Baby milk (180 ml bottle)	200	1000	0:20- 0:40	---	Put spoon in the bottle, stir, Check temperature!

Dish	Microwave 				Comments
	Size (g)	Power (Watts)	Cook time (Mins.)	Stand- ing time (Mins.)	
Ready meals	400-500	600	4-6	5	Remove any aluminium covers, turn halfway through
Frozen ready meals	400-500	400	14-20	5	
Milk	1 cup approx. 200ml	1000	1:15-1:45	---	Put spoon in the container
Water	1 cup approx. 200ml	1000	1:30-2	---	
Sauce	200 ml	600	1-2	---	
Soup	300 ml	600	2-4	---	

Cooking

Dish	Microwave 				Comments
	Size (g)	Power (Watts)	Cook time (Mins.)	Stand- ing time (Mins.)	
Fish generally	500	500	8-10	---	Cook covered, turn container several times during cooking
Fish fillets	500	500	6-8	---	
Vegetables, short cooking time, fresh ¹⁾	500	600	12-16	---	Add approx. 50 ml water, cook covered, stir halfway through





36 electrolux **uses, tables and tips**











Dish	Microwave 				Comments
	Size (g)	Power (Watts)	Cook time (Mins.)	Stand- ing time (Mins.)	
Vegetables, short cooking time, frozen ¹⁾	500	600	14-18	---	Cook covered, stir halfway through
Vegetables, long cooking time, fresh ¹⁾	500	600	14-20		
Vegetables, long cooking time, frozen ¹⁾	500	600	18-24	---	
Boiled potatoes	800 g + 600 ml	1000	5-7	300 W / 15- 20	
Rice	300 g + 600 ml	1000	4-6	---	

1) Cook all vegetables with a cover on the container. The times given are guidelines only and depend upon the type and qualities of the foodstuffs.



Combi-Function Table

Oven Functions: Grill + Microwave 

Dish	Bake- ware/ Roasting dishes	Oven func- tion	Tem p. in °C	Mi- crow. Watt	Ove n level	Tim e in min s.	Comments
Chicken halves 2 x 600 g	Oven- proof glass dish on oven shelf	 + 	220	300	2	40	Turn after 20 mins. 5 mins. standing time
Potato gratin 1000 g		 + 	200	300	2	40	10 mins. standing time

Dish	Bake-ware/ Roasting dishes	Oven function	Temp. in °C	Microw. Watt	Oven level	Time in mins.	Comments
Roast neck of pork 1,100 g		 + 	200	300	1	70	Turn once halfway through 10 mins. standing time
Swiss apple tarts	Crunch plate on glass floor, pre-heat with pastry max. 5 mins. / 1000 W, turn once	 + 	220	400	---	25	Turn half-way through
Frozen cheese-cake , 2 x 70 g	Crunch plate on glass floor, pre-heat max.	 + 	230	200	---	25	Turn half-way through
Frozen toasted sandwich with ham and cheese, 2 x 100 g	4 mins. / 700 W turn 1 once	 + 	230	200 ---	---	20	Turn half-way through, turn over after 15 mins.
Frozen hamburger, 2 x 90 g		 + 	250	300	---	20	Turn half-way through, turn over after 12 mins.

38 electrolux **uses, tables and tips**

Dish	Bake-ware/ Roasting dishes	Oven function	Tem p. in °C	Mi-crow. Watt	Ove n level	Tim e in min s.	Comments
Frozen pizza Ø 26cm 320 g		 + 	250	200	---	15	Turn half-way through

The cooking times and temperatures given are guidelines only and depend upon the type and the qualities of the food.

Tips for the microwave

Result	Remedy
You cannot find details for the amount of food prepared.	Look for a similar food. Increase or shorten the length of the cooking times according to the following rule: Double the amount = almost double the time Half the amount = half the time
The food has got too dry.	Set shorter cooking time or select lower microwave power.
The food is still not defrosted, hot or cooked after the time has elapsed.	Set longer cooking time or select higher microwave power. Please note that taller dishes need longer.
After the cooking time has elapsed, the food is overheated at the edge but is still not ready in the middle.	Next time select a lower power and a longer time. Stir liquids, e. g. soup, halfway through.

Test dishes in accordance with IEC 60705

(Microwave power 1000 Watt)

The quality and function of microwave appliances are tested by test institutes using special dishes.

Dish	Power Watt	Oven function	Oven level	Cook time Mins.	Standing time Mins.	Comment
Egg custard (12.3.1)	300		Glass floor	30-40	120	Turn dish once after half the time
Fatless sponge (12.3.2)	600		Glass floor	8-10	5	
Cooking meat loaf (12.3.3)	500		Glass floor	20-22	5	Cover, turn dish once halfway through cooking time
Defrosting mince (13.3.)	100		Glass floor	15-20	5	Turn after half the time, remove defrosted parts
Defrosting raspberries (B.2.1)	100		Glass floor	11-13	5	Cover







Programmes



The appliance has 10 programmed functions, which can be selected one after the other using the Recipes  button.

For settings, see section Additional Functions: Microwave Programmes.

Programme	Function	Recipe	Pre-setting	Weight		Time as per Presetting	Keep warm function "HH"
				min.	max.		
P 1	Defrost 1) 	Poultry 	1000 g	100 g	1500 g	19 mins. 40 secs.	No

40 electrolux uses, tables and tips

Pro-gramme	Func-tion	Recipe		Weight			Time as per Preset-ting	Keep warm function "HH"
				Pre-set-ting	min.	max.		
P 2		Meat		800 g	100 g	1500 g	17 mins. 36 secs.	No
P 3		Fish		1000 g	100 g	1500 g	15 mins. 20 secs.	No
P 4		Bread		500 g	100 g	1500 g	6 mins.	No
P 5	Boil ¹⁾ 	Frozen vegeta-bles (small) + 50 ml water		800 g	100 g	1000 g	15 mins. 44 secs.	Yes
P 6		Frozen vegeta-bles (large) + 50 ml water		800 g	100 g	1000 g	22 mins. 56 secs.	Yes
P 7		Fresh vegeta-bles (small) + 50 ml water		800 g	100 g	1000 g	24 mins.	No

Pro-gramme	Func-tion	Recipe		Weight			Time as per Preset-ting	Keep warm function "HH"
				Pre-set-ting	min.	max.		
P 8		Fresh vegeta-bles (large) + 50 ml water		800 g	100 g	1000 g	26 mins. 40 secs.	No
P 9		Pota-toes + 100 ml water		600 g	100 g	1000 g	17 mins. 12 secs.	No
P 10		Fish		1000 g	100 g	1000 g	21 mins. 40 secs.	Yes

1) With the functions Defrost and Boil turn the food several times

Cleaning and Care



For cleaning, the appliance must be switched off and cooled down.



Do not use any scouring agents, sharp cleaning tools or scourers.



For safety reasons, do not clean the appliance with steam jet or high-pressure cleaning equipment.

Do not use harsh abrasive cleaners or sharp metal scrapers to clean the oven door glass since they can scratch the surface, which may result in shattering of the glass.

Outside of the appliance

- Wipe the front of the appliance with a soft cloth and warm water and washing up liquid.
- For metal fronts, use normal commercially available cleaning agents.

Oven interior

Clean the appliance after each use. In this way, dirt is easier to clean off and is not allowed to burn on.

1. When the oven door is opened, the oven light switches itself on automatically.
2. After every use, wipe the oven with a solution of washing-up liquid and allow to dry.



Remove stubborn dirt with special oven cleaners.



If using an oven cleaner spray, please follow the manufacturer's instructions exactly.

Accessories

Wash all slide-in units (shelf unit, baking tray, shelf support rails etc.) after each use and dry well. Soak briefly to make them easier to clean.

Side rails

The left and right-hand side rails can be removed from the oven, so that the side walls of the oven can be cleaned.

Removing side rails

To remove rails, take hold of them and then raise and lift them out of the mounts.

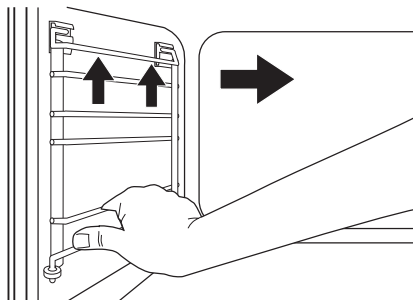

Replacing the side rails

To insert rails, re-insert them into the mounts and lower them.

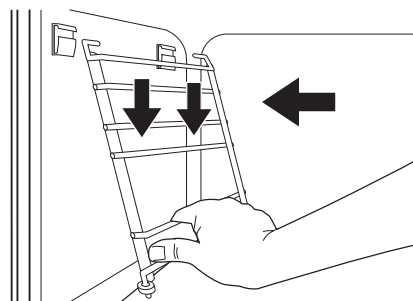

Oven lighting



Risk of electric shock! Before replacing the oven light bulb:

- Switch oven off.
- Take the fuses out of the fuse box or switch off.



To protect the oven light bulb and the glass cover, lay a cloth on the floor of the oven.

Replacing the side oven light bulb/ Cleaning the glass cover

1. Take out the side rails on the left.
2. Take off the glass cover by turning it anti-clockwise and clean it.

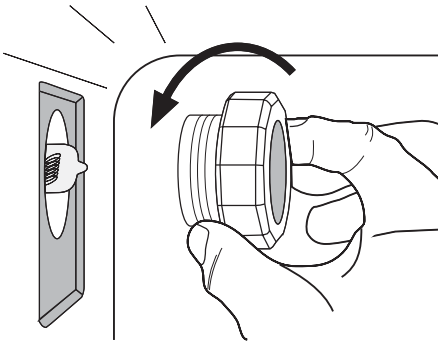





3. If necessary: Replace with halogen oven light bulb 20 Watt, 12 V, 300°C heat-resistant.



Always take hold of the halogen light bulb with a cloth, to avoid burning on grease residues.

4. Re-fit the glass cover.
5. Replace the side rails.

What to do if ...

Problem	Possible cause	Remedy
The oven is not heating up	The oven has not been switched on	Switch oven on
	The clock has not been set	Set the current time on the clock
	The required settings have not been made	Check the settings
	The oven's safety cut-out has been triggered	See Safety Cut-out
	The child safety device is activated.	Deactivate child safety device
	The house wiring fuse (in the fuse box) has tripped	Check fuse If the fuses trip several times, please call a qualified electrician
The microwave is not working	The oven door is not properly closed	Close the oven door
	The door seals and door seal surfaces are dirty	Clean door seals and door seal surfaces
	The Start  button was not touched	Press the Start  button.
The oven lighting is not operating	The oven light bulb is faulty	Replace oven light bulb
"d" is lit in the display and the oven is not heating up Fan not operating	Test mode is switched on	Switch off the appliance Press and hold  and  buttons at the same time until acoustic signal sounds and "d" indicator goes out

If you are unable to remedy the problem by following the above suggestions, please contact your dealer or the Customer Care Department.



Repairs to the appliance are only to be carried out by qualified service engineers. Considerable danger to the user may result from improper repairs.



If the appliance has been wrongly operated, the visit from the custom-

er service technician or dealer may not take place free of charge, even during the warranty period.



Advice on cookers with metal fronts: Because of the cold surface at the front of the cooker, opening the oven door during (or just after) baking or roasting may cause the glass to steam up.

Installation Instructions



The new appliance may only be installed and connected by a registered installation engineer. Please comply with this. If you do not, any damage resulting is not covered by the warranty.

If the supply cord is damaged, it must be replaced by the manufacturer, its service agent or similarly qualified persons in order to avoid a hazard.

Safety information for the installer

- The set-up of the electrical installation is arranged so that the appliance can

be isolated from the mains with a minimum 3mm all-pole contact separation.

Suitable separation devices include e. g. cut-outs, fuses (screw fuses are to be taken out of the holder), RCD's and contactors.

- The site must provide a connection to the electrical supply by means of a socket that is accessible and outside the coordination space.
- Anti-shock protection must be provided by the installation.
- The built-in unit must meet the stability requirements of DIN 68930.

1a

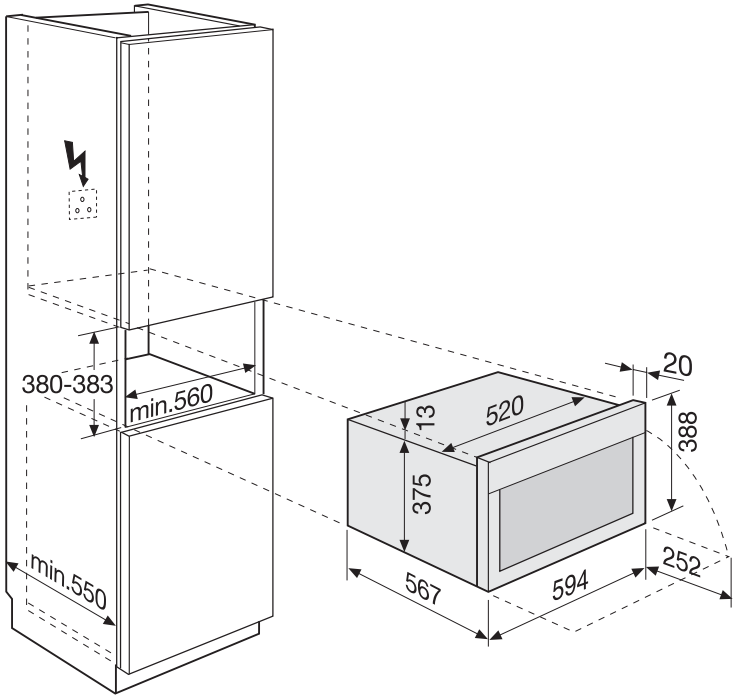

1b

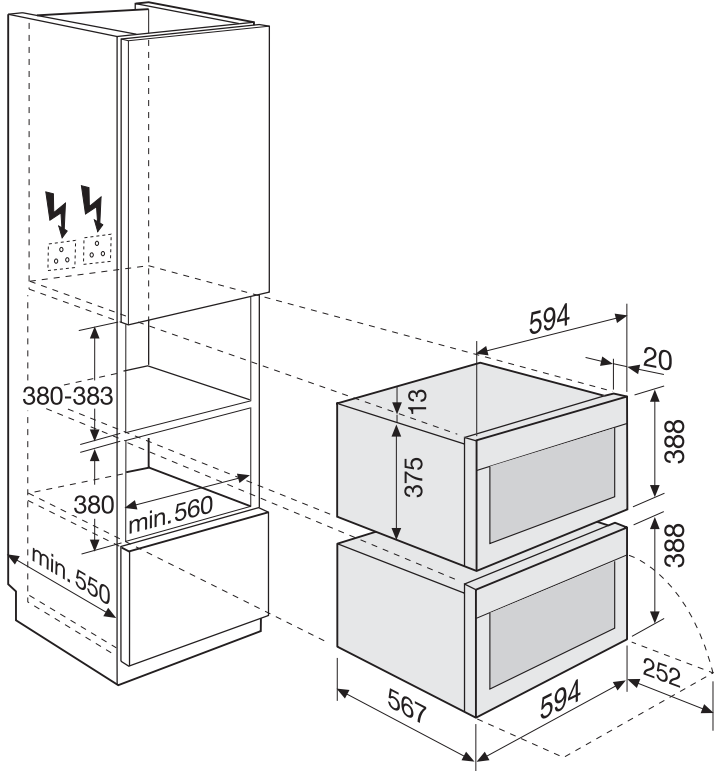

1c

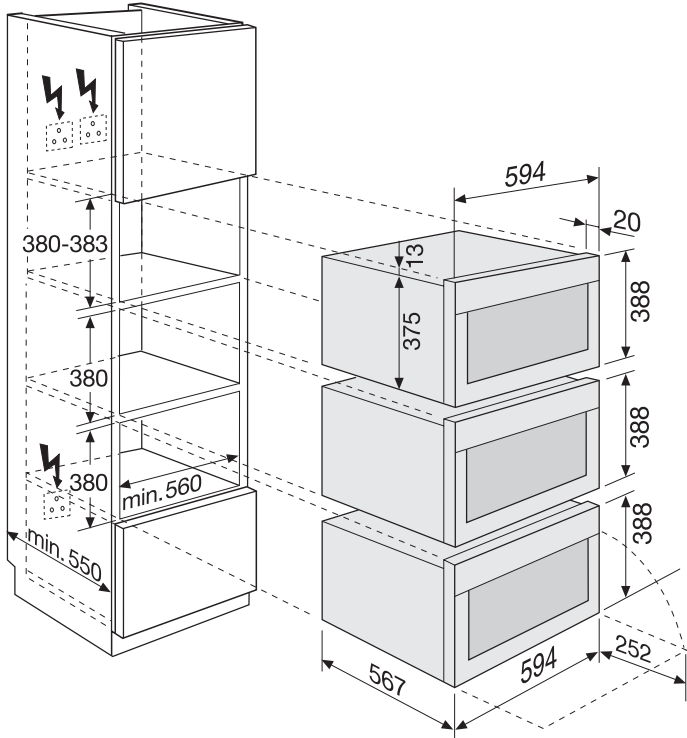

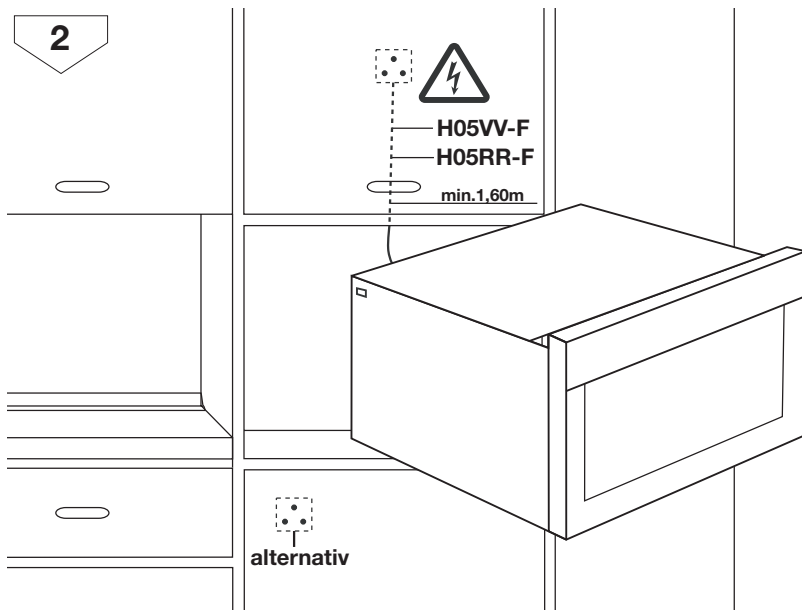

3

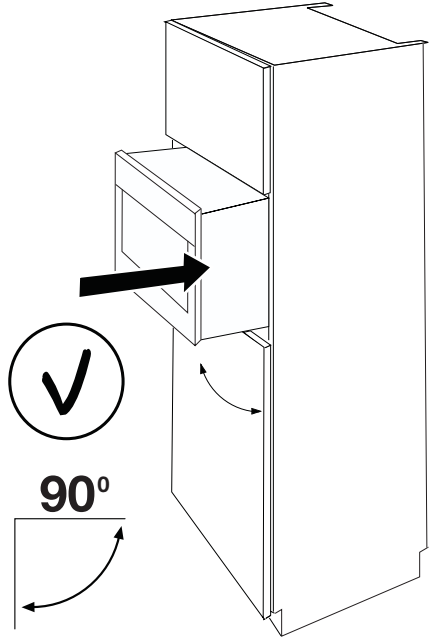
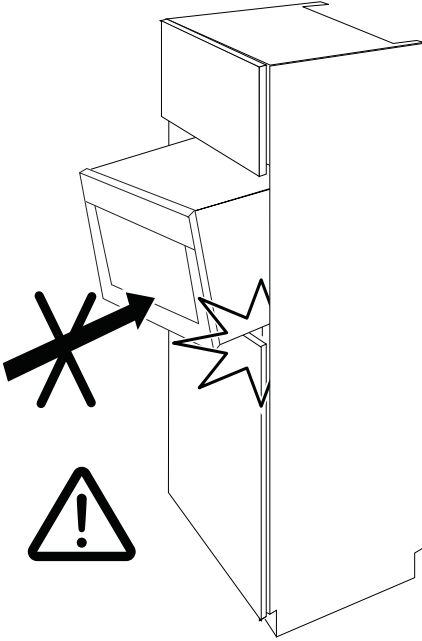

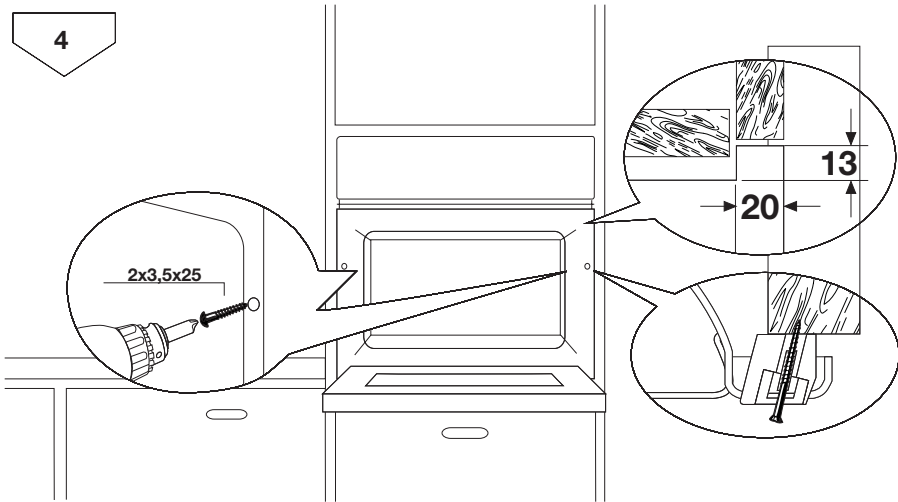

Disposal



Packaging material

The packaging materials are environmentally friendly and can be recycled. The plastic components are identified by markings, e.g. >PE<, >PS<, etc. Please dispose of the packaging materials in the appropriate container at the community waste disposal facilities.

The symbol on the product or on its packaging indicates that this product may not be treated as household waste.

Instead it should be taken to the appropriate collection point for the recycling of electrical and electronic equipment. By ensuring this product is disposed of correctly, you will help prevent potential negative consequences for the environment and human health, which could otherwise be caused by inappropriate waste handling of this product. For more detailed information about recycling of this product, please contact your local council, your household waste disposal service or the shop where you purchased the product.



So that the old appliance can no longer cause any danger, make it un-

usable before disposing of it. To do this, disconnect the appliance from the mains supply and remove the mains cable from the appliance.

European Guarantee

This appliance is guaranteed by Electrolux in each of the countries listed at the back of this user manual, for the period specified in the appliance guarantee or otherwise by law. If you move from one of these countries to another of the countries listed, the appliance guarantee will move with you subject to the following qualifications:-

- The appliance guarantee starts from the date you first purchased the appliance which will be evidenced by production of a valid purchase document issued by the seller of the appliance.
- The appliance guarantee is for the same period and to the same extent for labour and parts as exists in your

new country of residence for this particular model or range of appliances.

- The appliance guarantee is personal to the original purchaser of the appliance and cannot be transferred to another user.
- The appliance is installed and used in accordance with instructions issued by Electrolux and is only used within the home, i.e. is not used for commercial purposes.
- The appliance is installed in accordance with all relevant regulations in force within your new country of residence.

The provisions of this European Guarantee do not affect any of the rights granted to you by law.

www.electrolux.com

		
Albania	+35 5 4 261 450	Rr. Pjeter Bogdani Nr. 7 Tirane
Belgique/België/Belgien	+32 2 363 04 44	Bergensesteenweg 719, 1502 Lembeek
Česká republika	+420 2 61 12 61 12	Budějovická 3, Praha 4, 140 21
Danmark	+45 70 11 74 00	Sjællandsgade 2, 7000 Fredericia

		
Deutschland	+49 180 32 26 622	Muggenhofer Str. 135, 90429 Nürnberg
Eesti	+37 2 66 50 030	Mustamäe tee 24, 10621 Tallinn
España	+34 902 11 63 88	Carretera M-300, Km. 29,900 Alcalá de He- nares Madrid
France	www.electrolux.fr	
Great Britain	+44 8705 929 929	Addington Way, Luton, Bedfordshire LU4 9QQ
Hellas	+30 23 10 56 19 70	4, Limnou Str., 54627 Thessaloniki
Hrvatska	+385 1 63 23 338	Slavonska avenija 3, 10000 Zagreb
Ireland	+353 1 40 90 753	Long Mile Road Dublin 12
Italia	+39 (0) 434 558500	C.so Lino Zanussi, 26 - 33080 Porcia (PN)
Latvija	+37 17 84 59 34	Kr. Barona iela 130/2, LV-1012, Riga
Lietuva	+370 5 2780609	Ozo 10A, LT 08200 Vil- nius
Luxembourg	+352 42 431 301	Rue de Bitbourg, 7, L-1273 Hamm
Magyarország	+36 1 252 1773	H-1142 Budapest XIV, Erzsébet királyné útja 87
Nederland	+31 17 24 68 300	Vennootsweg 1, 2404 CG - Alphen aan den Rijn
Norge	+47 81 5 30 222	Risløkkvn. 2 , 0508 Oslo
Österreich	+43 18 66 400	Herziggasse 9, 1230 Wien

		
Polska	+48 22 43 47 300	ul. Kolejowa 5/7, Warszawa
Portugal	+35 12 14 40 39 39	Quinta da Fonte - Edifício Gonçalves Zarco - Q 35 -2774-518 Paço de Arcos
Romania	+40 21 451 20 30	Str. Garii Progresului 2, S4, 040671 RO
Schweiz - Suisse - Sviz-zera	+41 62 88 99 111	Industriestrasse 10, CH-5506 Mägenwil
Slovenija	+38 61 24 25 731	Gerbičeva ulica 98, 1000 Ljubljana
Slovensko	+421 2 43 33 43 22	Electrolux Slovakia s.r.o., Electrolux Domáce spotrebiče SK, Seberínho 1, 821 03 Bratislava
Suomi	www.electrolux.fi	
Sverige	+46 (0)771 76 76 76	Electrolux Service, S:t Göransgatan 143, S-105 45 Stockholm
Türkiye	+90 21 22 93 10 25	Tarlabası caddesi no : 35 Taksim İstanbul
Россия	+7 495 937 7837	129090 Москва, Олимпийский проспект, 16, БЦ "Олимпик"

www.electrolux.com