

C e r a m i c g l a s s i n d u c t i o n h o b

Installation and Operating Instructions

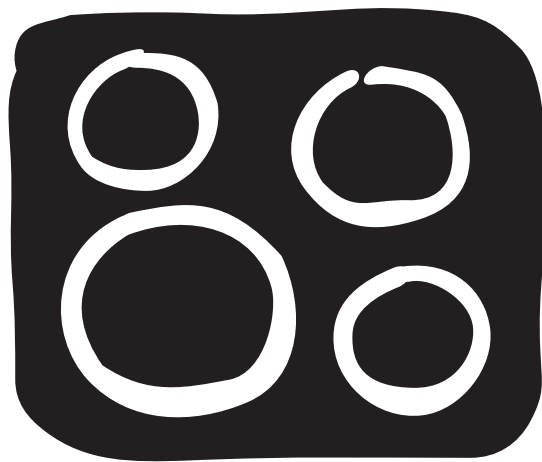

EHD 6676 P

Dear Customer,

Please read these user instructions carefully and keep them to refer to later.

Please pass the user instructions on to any future owner of the appliance.

The following symbols are used in the text:



Safety instructions

Warning! Information that affects your personal safety.

Important! Information that prevents damage to the appliance.



Useful tips and hints



Environmental information

Contents

Operating Instructions	4
Safety instructions	4
Description of the Appliance	5
Cooking surface layout	5
Control panel layout	5
Touch Control sensor fields	6
Displays	6
Residual heat indicator	6
Operating the appliance	7
Switching the appliance on and off	7
Setting the heat setting	7
Switching the double ring cooking zone on and off	7
Using the automatic warm-up function	8
Locking/unlocking the control panel	9
Using the child safety device	9
Switching the power function on and off	10
Using the timer	11
Safety cut-out	13
Tips on Cooking and Frying	14
Cookware	14
Cookware for induction cooking zones	14
Tips on energy saving	15
Examples of cooking applications	15
Cleaning and Care	16
What to do if	17
Disposal	18
Installation Instructions	19
Electrical Connection	19
Assembly	20
Rating Plate	24
Warranty conditions	25
Service	27

Operating Instructions

Safety instructions

 Please comply with these instructions. If you do not, any damage resulting is not covered by the warranty.

 This appliance conforms with the following EU Directives:

- 73/23/EEC dated 19.02.1973 Low Voltage Directive
- 89/336/EEC dated 03.05.1989 EMC Directive inclusive of Amending Directive 92/31/EEC
- 93/68/EEC dated 22.07.1993 CE Marking Directive

Correct use

- This appliance should be used only for normal domestic cooking and frying of food.
- The appliance must not be used as a work surface or as a storage surface.
- Additions or modifications to the appliance are not permitted.
- Do not place or store flammable liquids, highly inflammable materials or fusible objects (e.g. plastic film, plastic, aluminium) on or near the appliance.

Child Safety

The cooking zones will become hot when you cook. Therefore, always keep small children away from the appliance.

For Australia:

The appliance is not intended for use by young children or infirm persons without supervision. Young children should be supervised to ensure that they do not play with the appliance.

General safety

- The appliance may only be installed and connected by trained, registered service engineers.
- Built-in appliances may only be used after they have built in to suitable built-in units and work surfaces that meet standards.
- In the event of faults with the appliance or damage to the glass ceramic (cracks, scratches or splits), the appliance must be switched off and disconnected from the electrical supply, to prevent the possibility of an electric shock.
- Repairs to the appliance must only be carried out by trained registered service engineers.

Safety during use

- Remove stickers and film from the glass ceramic.
- There is the risk of burns from the appliance if used carelessly.
- Cables from electrical appliances must not touch the hot surface of the appliance or hot cookware.
- Overheated fats and oils can ignite quickly. When cooking with fat or oil (e.g. chips) do not leave the appliance unattended.
- Switch the cooking zones off after each use.
- Users with implanted pacemakers should keep their upper body at least 30 cm from induction cooking zones that are switched on.
- Risk of burns! Do not place objects made of metal, such as knives, forks, spoons and saucepan lids on the cooking surface, as they can get hot.

Safety when cleaning

- For cleaning, the appliance must be switched off and cooled down.
- For safety reasons, the cleaning of the appliance with steam jet or high-pressure cleaning equipment is not permitted.

How to avoid damage to the appliance

- The glass ceramic can be damaged by objects falling onto it.
- The edge of the glass ceramic can be damaged by being knocked by the cookware.
- Cookware made of cast iron, cast aluminium or with damaged bottoms can scratch the glass ceramic if pushed across the surface.
- Objects that melt and things that boil over can burn onto the glass ceramic and should be removed straightaway.
- Do not use the cooking zones with empty cookware or without cookware.
- The ventilation gap of 5mm between the worktop and front of the unit underneath it must not be covered.

Description of the Appliance

Cooking surface layout

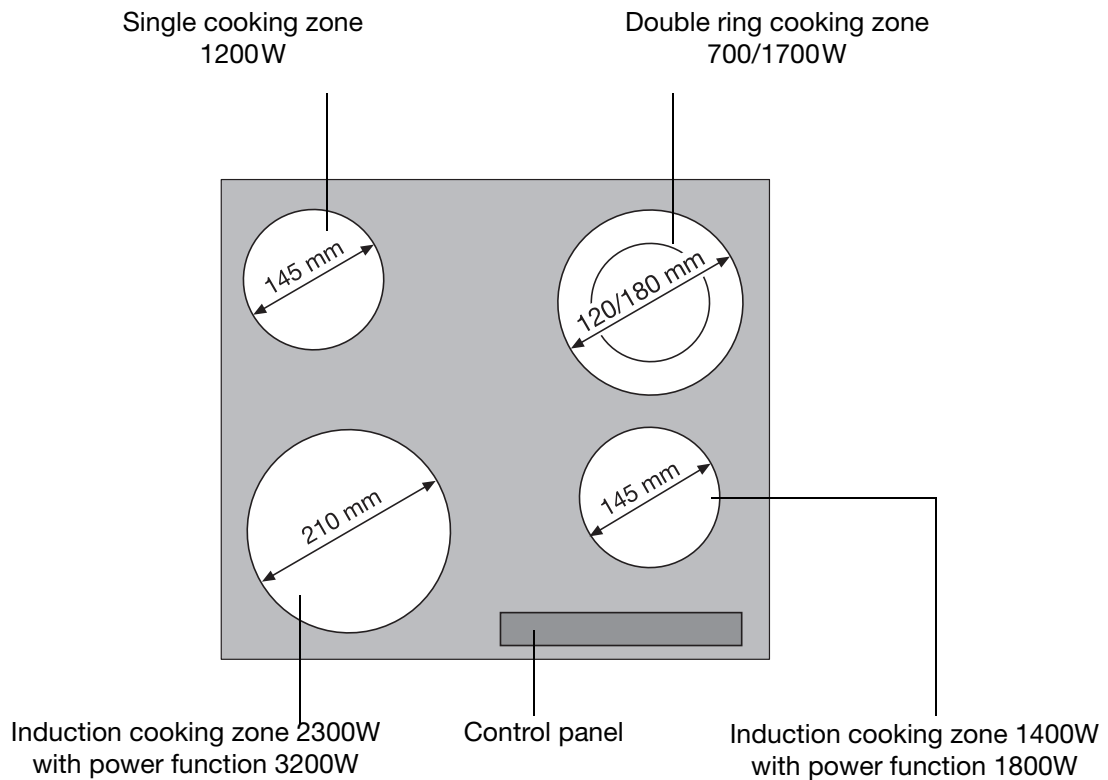



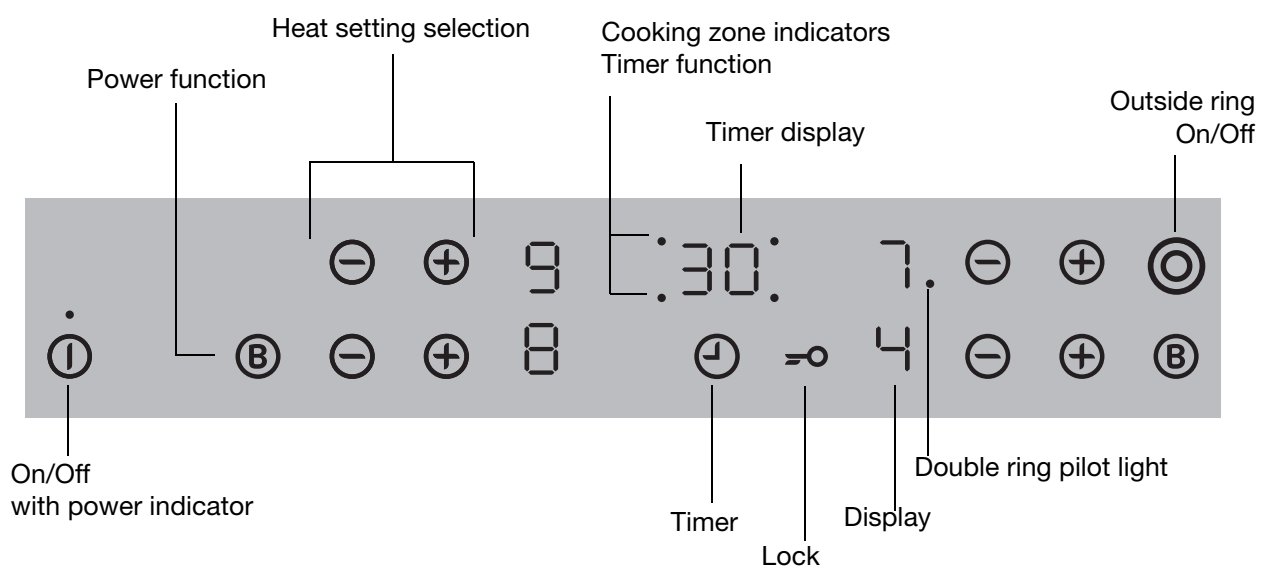



Control panel layout













Touch Control sensor fields

The appliance is operated using Touch Control sensor fields. Functions are controlled by touching sensor fields and confirmed by displays and acoustic signals.

Touch the sensor fields from above, without covering other sensor fields.

Sensor field		Function
	On / Off	To switch the appliance on and off
	Increase settings	Increasing heat setting/time
	Decrease settings	Decreasing heat setting/time
	Timer	Timer selection
	Lock	Locking/unlocking the control panel
	Power	Switching the power function on and off
	Double ring switch	Switches outside ring on and off

Displays

Display	Description	
	Cooking zone is switched off	
	Keep warm setting	Keep warm setting is set
	Heat settings	Heat setting is set
	Automatic warm up function	Automatic warm-up function is activated
	Fault	Malfunction has occurred
	Pan detection	Cookware is unsuitable or too small or no cookware has been placed on the cooking zone
	Residual heat	Cooking zone is still hot
	Child safety device	Lock/child safety device is engaged
	Power	Power function is switched on
	Safety cut-out	Safety cut-out has been activated

Residual heat indicator



Warning! Risk of burns from residual heat. After being switched off, the cooking zones need some time to cool down. Look at the residual heat indicator .



Residual heat can be used for melting and keeping food warm.

The **induction cooking zones** create the heat required for cooking directly in the base of the cookware. The glass ceramic is merely heated by the residual heat of the cookware.

The **cooling fan** switches itself on and off depending upon the temperature of the electronics.

Operating the appliance

i Use the induction cooking zones with suitable cookware.

Switching the appliance on and off

	Control panel	Display	Pilot light
Switch on	Touch I for 2 seconds	I / H	lights up
Switch off	Touch I for 1 second	H / none	goes out

i After switching on, within approx. 10 seconds a heat setting or a function must be set, otherwise the appliance automatically switches itself off.

Setting the heat setting

	Control panel	Display
Increase	Touch +	1 to 9 / P
Decrease	Touch -	9 to 1
Switch off	Touch + and - at the same time	0

i The keep warm setting **0** lies between **1** and **9**. The keep warm setting can be set using **+** or **-**. It is used to keep food warm.

Switching the double ring cooking zone on and off

With the double ring cooking zone the heating surface can be matched to the size of the cookware.

	Control panel	Pilot light
Switch on	Touch ⊙ for 1-2 seconds	lights up
Switch off	Touch ⊙ for 1-2 seconds	goes out

Using the automatic warm-up function

All cooking zones are equipped with an automatic warm-up function. The automatic warm-up function sets the cooking zone to the highest setting for a certain period of time and then automatically switches back to the cooking setting that was originally set.

Step	Control panel	Display
1.	Setting the level 9 / P	9 / P
2.	Place to one side for a moment	9 / P
3.	+ touch	R
4.	- touch in order to set the desired cooking setting	8 until 1 / U after 3 seconds R

i If during the automatic warm up **R** a higher heat setting is selected, e.g. from **3** to **5**, the automatic warm up is adjusted.

i If there is still residual heat on the cooking zone (display **H**), the automatic warm up is not performed.

The length of time that the automatic warm up function operates depends on the heat setting selected.

Heat setting	Length of the automatic warm up Radiation element [min:sec]	Length of the automatic warm up Induction [min:sec]
u	0:30	0:10
1	1:00	0:10
2	1:40	0:10
3	4:50	3:10
4	6:30	5:50
5	10:10	10:10
6	2:30	2:00
7	3:30	2:30
8	4:30	2:50
9	---	---

Locking/unlocking the control panel

The control panel, with the exception of the “On/Off” sensor field, can be locked at any time in order to prevent the settings being changed e.g. by wiping over the panel with a cloth.

	Control panel	Display
Switch on	Touch $\Rightarrow \text{O}$	L (for 5 seconds)
Switch off	Touch $\Rightarrow \text{O}$	previously set heat setting

i When you switch the appliance off, the locking function is automatically switched off.

Using the child safety device

The child safety device prevents unintentional use of the appliance.

Setting the child safety device

Step	Control panel	Display/Signal
1.	① Switch on the appliance (Do not set a heat setting)	O
2.	Touch $\Rightarrow \text{O}$ until the signal sounds	Acoustic signal
3.	Touch \oplus	L

Appliance switches off. The child safety device is engaged.

Releasing the child safety device

Step	Control panel	Display/Signal
1.	① Switch on the appliance	L
2.	Touch $\Rightarrow \text{O}$ until the signal sounds	Acoustic signal
3.	Touch \ominus	

Appliance switches off. The child safety device is released.

Overriding the child safety device

The child safety device can be released in this way for a single cooking session; it remains activated afterwards.

Step	Control panel	Display/Signal
1.	① Switch on the appliance	L
2.	Touch \oplus and \ominus at the same time	O / acoustic signal

Until the appliance is next switched off, it can be used as normal.

Switching the power function on and off

The power function **P** makes more power available to the induction cooking zones, e.g. to bring a large quantity of water to the boil quickly.

The power function is activated for 10 minutes. After that the induction cooking zone automatically switches back to heat setting 9.

	Control panel	Display
Switch on	Touch P	P
Switch off	Touch 9	9
	Touch ⊖	9

Power Management

The cooking zones have a maximum power available to them.

If this power range is exceeded by switching on the power function, Power Management reduces the heat setting of another cooking zone.

The display for this cooking zone alternates for two minutes between the set heat setting and the maximum possible heat setting. Thereafter the actual heat setting is displayed.

Example:

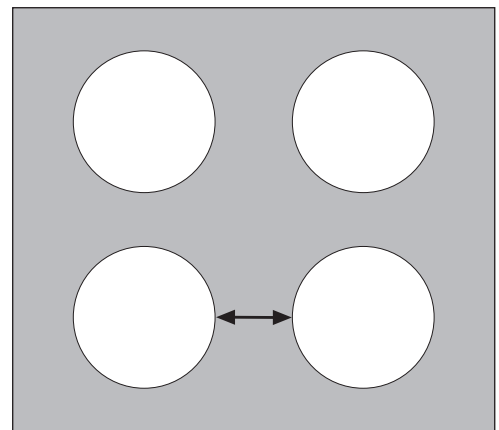

Last cooking zone switched on	Other cooking zone		
	set heat setting	display	actual heat setting
P	9	7 alternating with 9	7

i If the power function has ended, the cooking zones automatically switch back to the heat setting set previously.

Using the timer





All cooking zones can use each use one of the two timer functions at the same time.

Function	Condition	Outcome after the time has elapsed
Automatic cut-out	a heat setting is set	acoustic signal 00 flashes Cooking zone switches off
Countdown timer	cooking zones not in use	acoustic signal 00 flashes

i If a cooking zone is switched off, the timer function set is also switched off.

i If a heat setting is set on this cooking zone in addition to a countdown timer, the cooking zone is switched off after the time set has elapsed.

Selecting a cooking zone

Step	Control panel	Display
1.	Touch ⊖ once	Pilot light of the first cooking zone flashes 
2.	Touch ⊖ once	Pilot light of the second cooking zone flashes 
3.	Touch ⊖ once	Pilot light of the third cooking zone flashes 
4.	Touch ⊖ once	Pilot light of the fourth cooking zone flashes 

i If the pilot light is flashing more slowly, the heat setting can be set or modified.

i If other timer functions are set, after a few seconds the shortest remaining time of all the timer functions is displayed and the corresponding pilot light flashes.

Setting the time

Step	Control panel field	Display
1.	⌚ Select cooking zone	Pilot light of the cooking zone selected flashes
2.	Touch ⊕ or ⊖ for the cooking zone selected	00 to 99 minutes

After a few seconds the pilot light flashes more slowly.
The time is set.
The time counts down.

Switching off the timer function

Step	Control panel field	Display
1.	⌚ Select cooking zone	Pilot light of the cooking zone selected flashes faster The time remaining is displayed
2.	Touch ⊖ for the cooking zone selected	The time remaining counts down to 00.

The pilot light goes out.
The timer function for the selected cooking zone is switched off.

Changing the time

Step	Control panel field	Display
1.	⌚ Select cooking zone	Pilot light of the cooking zone selected flashes faster The time remaining is displayed
2.	Touch ⊕ or ⊖ for the cooking zone selected	01 to 99 minutes

After a few seconds the pilot light flashes more slowly.
The time is set.
The time counts down.

Displaying the time remaining for a cooking zone

Step	Control panel field	Display
1.	⌚ Select cooking zone	Pilot light of the cooking zone selected flashes faster The time remaining is displayed

After a few seconds the pilot light flashes more slowly.

Switching off the acoustic signal

Step	Control panel field	Acoustic signal
1.	Touch ⌚	Acoustic signal to acknowledge.

Acoustic signal stops.

Safety cut-out

Cooking surface

- If after switching on the cooking surface, a heat setting is not set for a cooking zone within approx. 10 seconds, the cooking surface automatically switches itself off.
- If one or more sensor fields are covered for longer than approx. 10 seconds, e.g. by a pan placed upon it, a signal sounds and the cooking surface switches off automatically.
- If all cooking zones are switched off, the cooking surface automatically switches itself off after approx. 10 seconds.

Control panel



Moisture (e.g. a wet cloth) or liquid boiling over onto the control panel immediately switches all cooking zones off.

Induction cooking zones

- In the event of overheating (e.g. when a pan boils dry) the cooking zone automatically switches itself off. is displayed. Before being used again, the cooking zone must be set to and allowed to cool down.
- If cookware that is not suitable is used, flashes in the display and after 10 minutes the display for the cooking zone switches itself off.

all cooking zones

- If one of the cooking zones is not switched off after a certain time, or if the heat setting is not modified, the relevant cooking zone switches off automatically.

Heat setting	Switches off after
1 - 2	6 hours
3 - 4	5 hours
5	4 hours
6 - 9	1.5 hours

Tips on Cooking and Frying

i Information on acrylamides

According to the latest scientific knowledge, intensive browning of food, especially in products containing starch, can constitute a health risk due to acrylamides. Therefore we recommend cooking at the lowest possible temperatures and not browning foods too much.

Cookware

- You can recognise good cookware from the bottoms of the pans. The bottom should be as thick and flat as possible.
- Cookware made of enamelled steel or with aluminium or copper bottoms can leave discolorations on the glass ceramic surface which are difficult or impossible to remove.

Cookware for induction cooking zones

Cookware made of	suitable
Steel, enamelled steel	yes
Cast iron	yes
Stainless steel	if appropriately labelled by the manufacturer
Aluminium, copper, brass	---
Glass, ceramic, porcelain	---

i Cookware for induction cooking zones is labelled as suitable by the manufacturer.

Test of suitability

Cookware is suitable for induction, if ...

- ... a little water is heated on an induction cooking zone set to heat setting 9 within a few seconds.
- ... a magnet sticks to the bottom of the cookware.

i Certain cookware can make noises when being used on induction cooking zones. These noises are not a fault in the appliance and do not affect operation in any way.

Pan size

Induction cooking zones adapt automatically to the size of the cookware bottom up to a certain limit. However the magnetic part of the cookware bottom must have a minimum diameter depending upon the size of the cooking zone.

i The cookware must be placed centrally on the cooking zone.

Tips on energy saving



Place cookware on the cooking zone before it is switched on.



If possible, always place a lid on the cookware.

Examples of cooking applications

The information given in the following table is for guidance only.

Heat setting	Cooking-process	suitable for	Cooking time	Tips/Hints
0		Off position		
1	Keeping food warm	Keeping cooked foods warm	as required	Cover
1-2	Melting	Hollandaise sauce, melting butter, chocolate, gelatine	5-25 mins.	Stir occasionally
	Solidifying	Fluffy omelettes, baked eggs	10-40 mins.	Cook with lid on
2-3	Simmering on low heat	Simmering rice and milk-based dishes Heating up ready-cooked meals	25-50 mins.	Add at least twice as much liquid as rice, stir milk dishes part way through cooking
3-4	Steaming Braising	Steaming vegetables, fish braising meat	20-45 mins.	With vegetables add only a little liquid (a few tablespoons)
4-5	Boiling	Steaming potatoes	20-60 mins.	Use only a little liquid, e. g.: max. ¼ l water for 750 g potatoes
		Cooking larger quantities of food, stews and soups	60-150 mins.	Up to 3 l liquid plus ingredients
6-7	Gentle Frying	Frying escalopes, veal cordon bleu, cutlets, rissoles, sausages, liver, roux, eggs, pancakes, doughnuts	Steady frying	Turn halfway through cooking
7-8	Heavy Frying	Hash browns, loin steaks, steaks, Flädle (pancakes for garnishing soup)	5-15 mins. per pan	Turn halfway through cooking
9	Boiling Searing Deep frying	Boiling large quantities of water, cooking pasta, searing meat (goulash, pot roast), deep frying chips		

The power function is suitable for heating large quantities of liquid.

Cleaning and Care



Take care! Risk of burns from residual heat.



Warning! Sharp objects and abrasive cleaning materials will damage the appliance. Clean with water and washing up liquid.



Warning! Residues from cleaning agents will damage the appliance. Remove residues with water and washing up liquid.

Cleaning the appliance after each use

1. Wipe the appliance with a damp cloth and a little washing up liquid.
2. Rub the appliance dry using a clean cloth.

Removing deposits

1. Place a scraper on the glass ceramic surface at an angle.
2. Remove residues by sliding the blade over the surface.
3. Wipe the appliance with a damp cloth and a little washing up liquid.
4. Rub the appliance dry using a clean cloth.

Type of dirt	Remove		
	immediately	when the appliance has cooled down	using
sugar, food containing sugar	yes	---	a scraper*
plastics, tin foil	yes	---	
limescale and water rings	---	yes	cleaner for glass ceramic or stainless steel*
fat splashes	---	yes	
shiny metallic discolorations	---	yes	

*Scrapers and cleaners for glass ceramic and stainless steel can be purchased in specialist shops











Remove stubborn residues with a cleaner for glass ceramic or stainless steel.



Scratches or dark stains on the glass ceramic that cannot be removed do not however affect the functioning of the appliance.

What to do if ...

Problem	Possible cause	Remedy
The cooking zones will not switch on or are not functioning	More than 10 seconds have passed since the appliance was switched on	Switch the appliance on again.
	The lock is switched on 	Switch off the lock (See the section "Locking/unlocking the control panel")
	The child safety device is switched on 	Deactivate the child safety device (See the section "Child safety device")
	Several sensor fields were touched at the same time	Only touch one sensor field
	The sensor fields are partly covered by a damp cloth or with liquid	Remove the cloth or the liquid. Switch the appliance on again.
	Safety cut-out has been triggered	Switch the appliance on again
The residual heat indicator is not displaying anything	The cooking zone was only on for a short time and is therefore not hot	If the cooking zone is supposed to be hot, call the Customer Service Department.
The automatic warm up function is not switching itself on	There is still residual heat on the cooking zone 	Let the cooking zone cool down
	The highest heat setting is set 	The highest heat setting has the same power as the automatic warm up function
Repeated acoustic signal (6x), appliance switches off	One or more sensor fields have been covered for longer than 10 seconds	Uncover sensor field
Acoustic signal sounds and appliance switches itself on and then off again; after 5 seconds another acoustic signal sounds	The On/Off sensor field has been covered up, e.g. by a cloth	Do not place any objects on the control panel
Display is switching between two heat settings	Power management is reducing the power of this cooking zone	See the section "Switching the power function on and off"
 flashes	Unsuitable cookware	Use suitable cookware
	No cookware on the cooking zone	Place cookware on the cooking zone
	The diameter of the bottom of the cookware is too small for the cooking zone	Move onto a smaller cooking zone Use suitable cookware
 is lit	Overheating protection for the cooking zone has been triggered	Switch off the cooking zone. Switch the cooking zone on again
 and number are displayed	Electronics fault	Disconnect the appliance from the electrical supply for a few minutes (Take the fuse out of the house's wiring system) If after switching on again,  is displayed again, call the customer service department

If you are unable to remedy the problem by following the above suggestions, please contact your dealer or the Customer Care Department.



Warning! Repairs to the appliance are only to be carried out by qualified service engineers. Considerable danger to the user may result from improper repairs.



If the appliance has been wrongly operated, the visit from the customer service technician or dealer may not take place free of charge, even during the warranty period.

Disposal



Packaging material

The packaging materials are environmentally friendly and can be recycled. The plastic components are identified by markings, e.g. >PE<, >PS<, etc. Please dispose of the packaging materials in the appropriate container at the community waste disposal facilities.



Old appliance

The symbol  on the product or on its packaging indicates that this product may not be treated as household waste. Instead it shall be handed over to the applicable collection point for the recycling of electrical and electronic equipment. By ensuring this product is disposed of correctly, you will help prevent potential negative consequences for the environment and human health, which could otherwise be caused by inappropriate waste handling of this product. For more detailed information about recycling of this product, please contact your local city office, your household waste disposal service or the shop where you purchased the product.

Installation Instructions

Safety instructions

The laws, ordinances, directives and standards in force in the country of use are to be followed (safety regulations, proper recycling in accordance with the regulations, etc.)

Installation may only be carried out by a qualified electrician.

The minimum distances to other appliances and units are to be observed.

A protective floor must be installed under the appliance.

The cut surfaces of the worktop are to be protected against moisture using a suitable sealant.

The sealant seals the appliance to the work top with no gap.

When building in, protect the underside of the appliance from steam and moisture, e.g. from a dishwasher or oven.

Avoid installing the appliance next to doors and under windows. Otherwise hot cookware may be knocked off the rings when doors and windows are opened.



WARNING!

Risk of injury from electrical current.

- The electrical mains terminal is live.
- Make electrical mains terminal free of voltage.
- Observe connection schematic.
- Observe electrical safety rules.
- Ensure anti-shock protection through correct installation by a qualified electrician.
- The appliance must be connected to the electrical supply by a qualified electrician.



IMPORTANT!

Risk of injury from electrical current.

Loose and inappropriate plug and socket connections can make the terminal overheat.

- Have the clamping joints correctedly installed by a qualified electrician.
- Use strain relief clamp on cable.

For Australia:

- CAUTION: The surface temperature exceeds 95°C. To avoid a hazard, underbench access must be restricted.
- Supply cords must have a temperature rating not less than 105°C.

Electrical Connection

Before connecting, check that the nominal voltage of the appliance, that is the voltage stated on the rating plate, corresponds to the available supply voltage. The rating plate is located on the lower casing of the hob.

The heating element voltage is AC230V~. The appliance also works perfectly on networks with AC220V~ or AC240V~.

The hob is to be connected to the mains using a device that allows the appliance to be disconnected from the mains at all poles with a contact opening width of at least 3 mm, eg. automatic line protecting cut-out, earth leakage trips or fuse.

A cable with minimum temperature rating of V90HT or one with a higher grade must be used as the mains connecting cable.

The connection must be carried out as shown in the diagram. The connecting links should be fitted according to the appropriate connection diagram. The earth lead is connected to terminal ⊕. The earth lead must be longer than leads carrying electric current.

The cable connections must be made in accordance with regulations and the terminal screws tightened securely.

Finally, the connecting cable is to be secured with the mains cable cleat and the covering closed by pressing firmly (lock into place).

Before switching on for the first time, any protective foil or stickers must be removed from the glass ceramic surface.



Once connected to the mains supply check that all cooking zones are ready for use by briefly switching each on in turn at the maximum setting.

Sticking on the seal

- Clean the worktop around the cut-out area.
- Stick the single-sided adhesive sealing tape provided on the underside of the hob around the outside edge ensuring that it is not stretched. The two ends of the tape should join in the middle of one side. After trimming the tape (allow it to overlap by 2-3 mm), press the two ends together.

Assembly

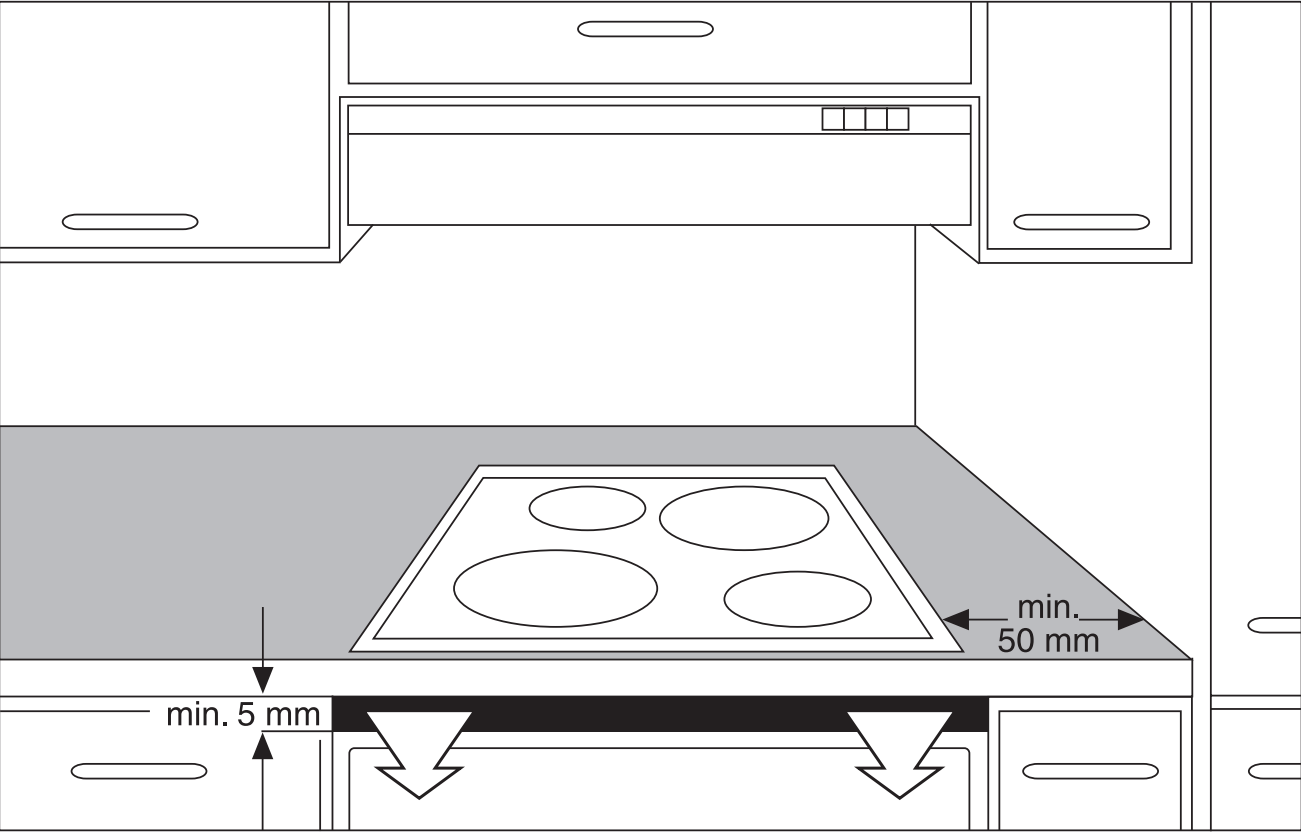
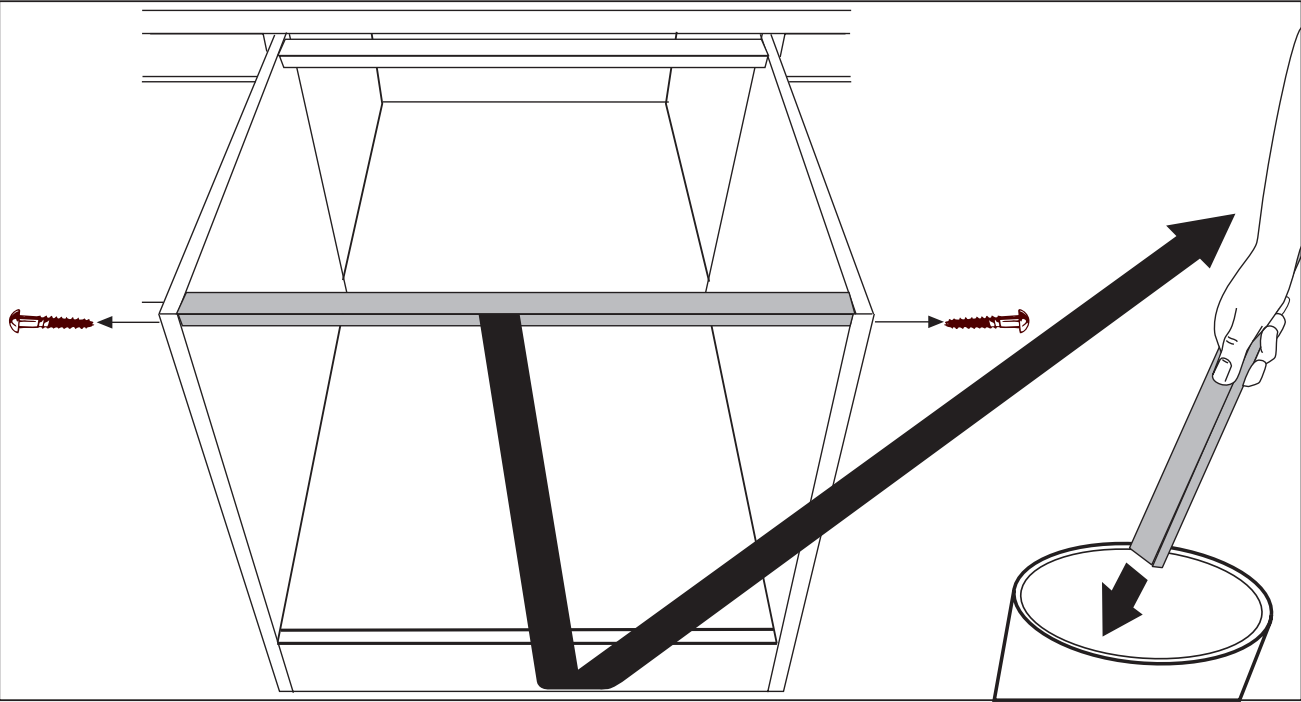

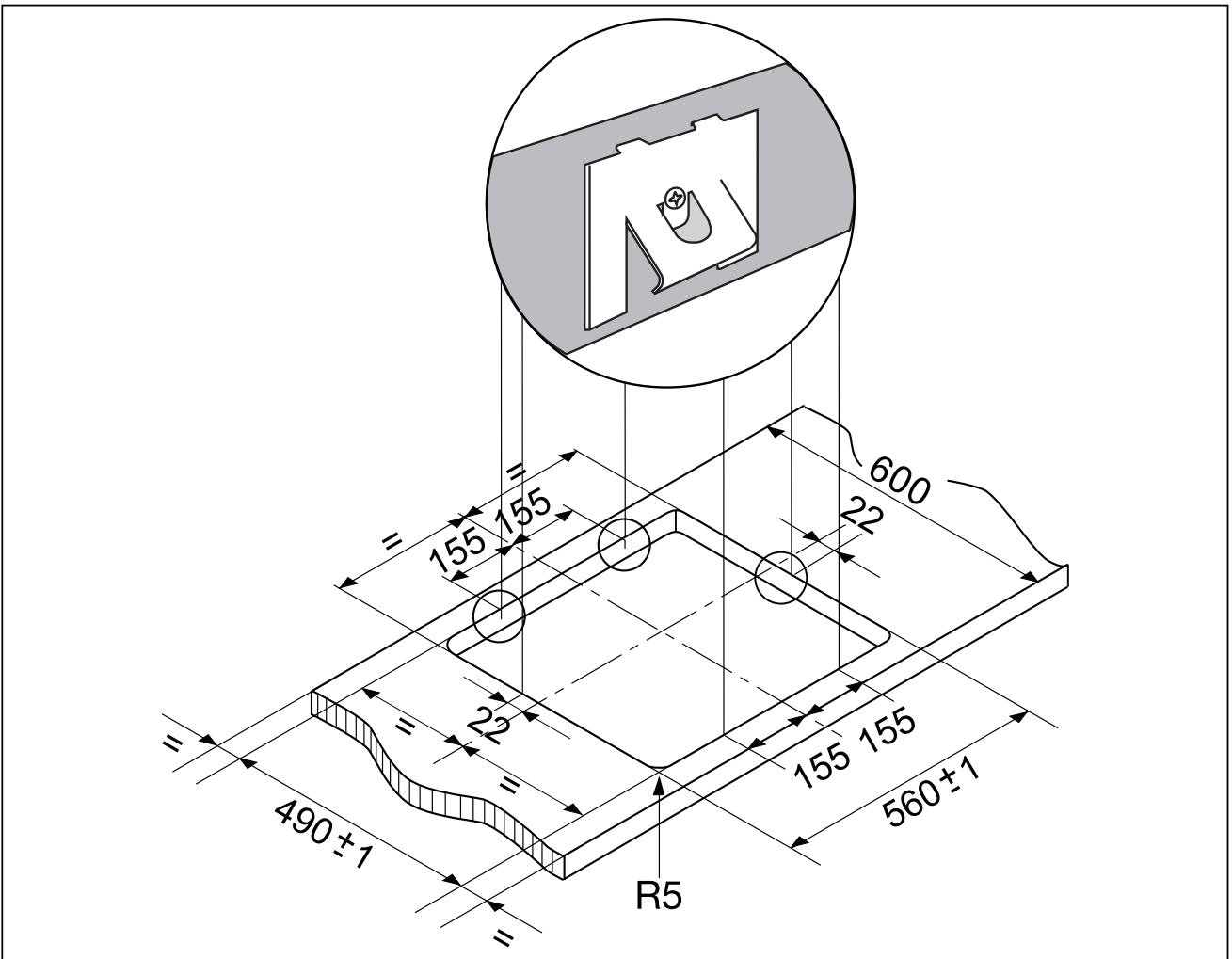
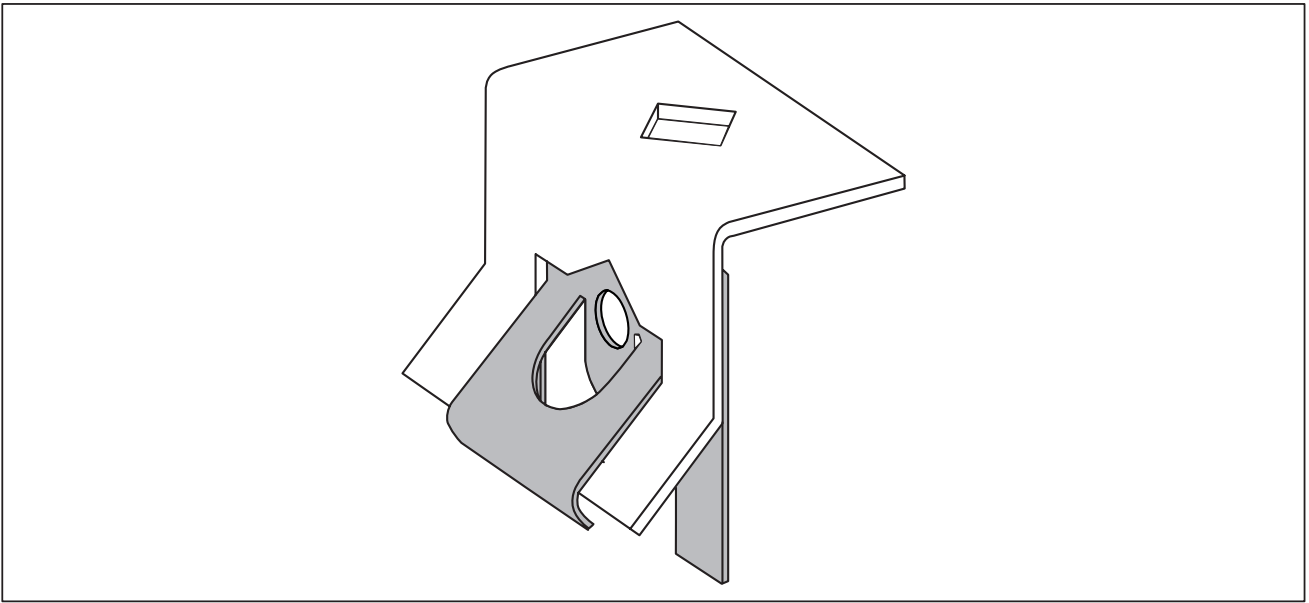

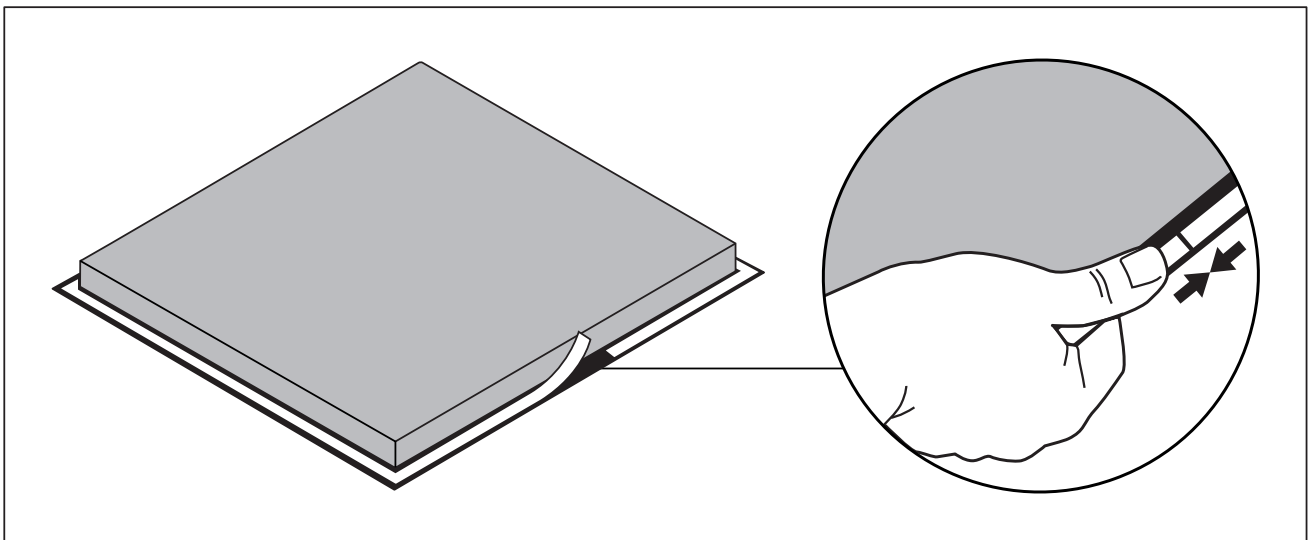
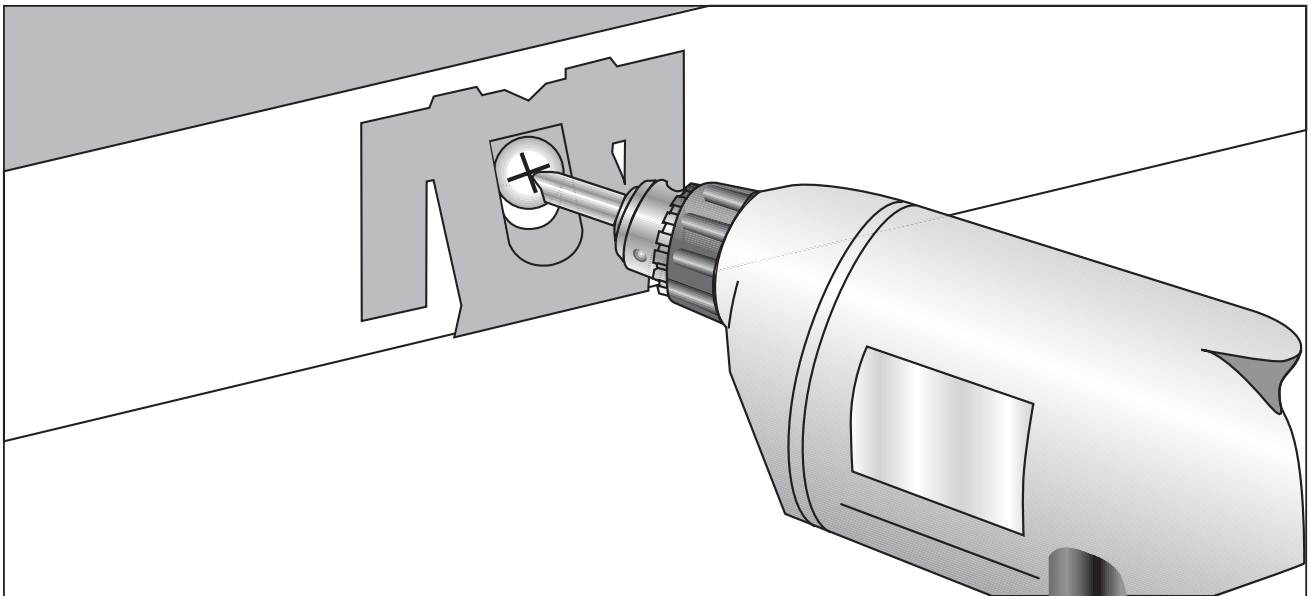
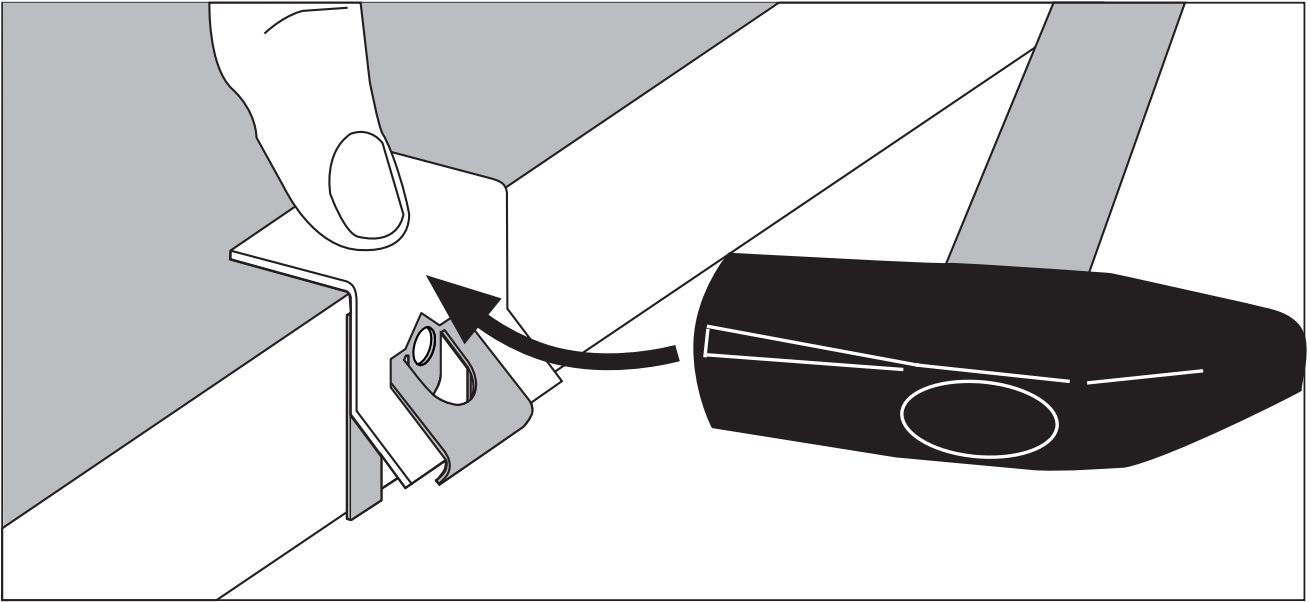

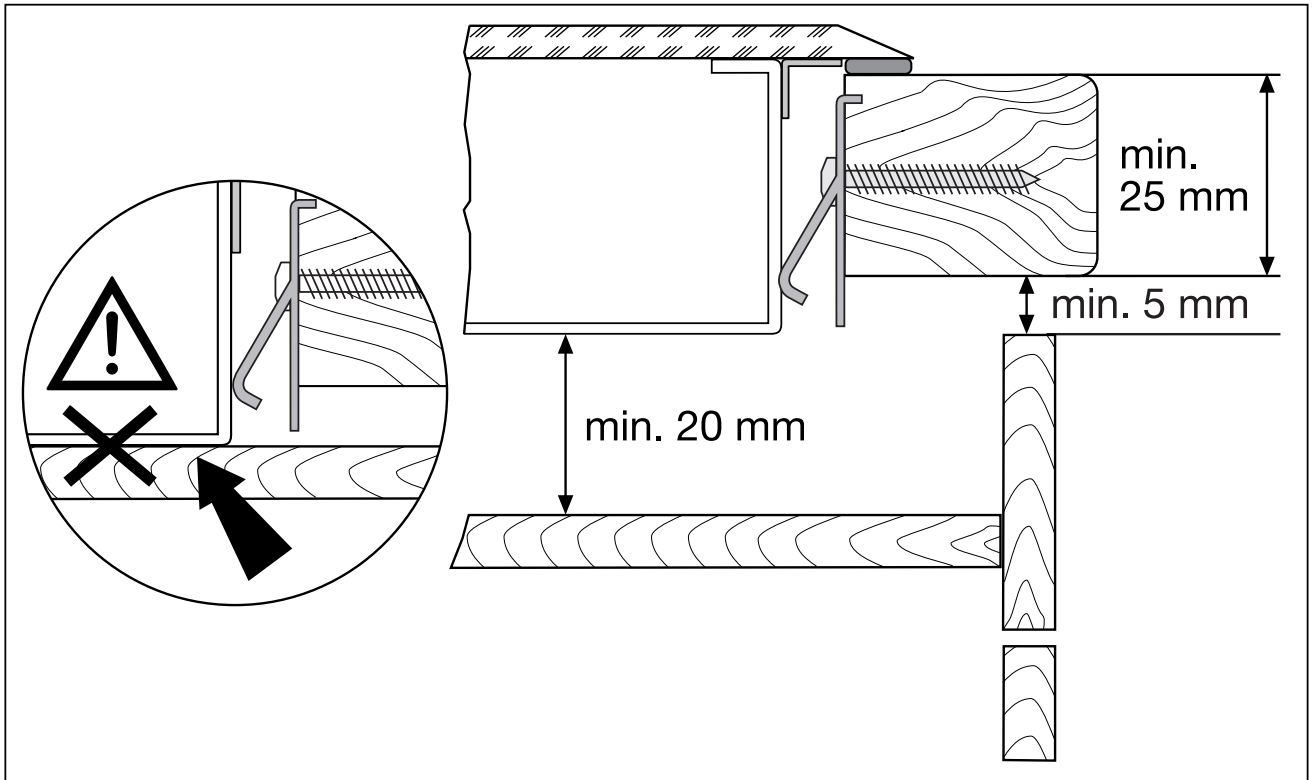





Rating Plate

Modell EHD6676P		Prod.Nr. 949 591 874	
Typ 55GAD83AG	230 V	50 Hz	Induction 3,7 kW
Made in Germany	Ser.Nr.	6,6 kW	
Electrolux	 		

Warranty conditions

Electrolux Warranty

FOR SALES IN AUSTRALIA AND NEW ZEALAND
APPLIANCE: Electrolux cooktop

This document sets out the terms and conditions of product warranties for Electrolux branded appliances. It is an important document. Please keep it with your proof of purchase documents in a safe place for future reference should you require service for your Electrolux appliance.

General Terms and Conditions

1. In this warranty

(a) 'Electrolux' means Electrolux Home Products Pty Ltd ABN 51 004 762 341 in respect of Appliances purchased in Australia and Electrolux (NZ) Limited in respect of Appliances purchased in New Zealand;

(b) 'Appliance' means any Electrolux product purchased by you accompanied by this document;

(c) 'Warranty Period' means

(i) where you use the Appliance for personal, domestic or household purposes in Australia the period of 24 months and in New Zealand the period of 24 months;

(ii) where you use the Appliance for commercial purposes, the period of 3 months, (if the period stated is 0 months you are not covered by this product warranty)

following the date of original purchase of the Appliance;

(d) 'you' means the purchaser of the Appliance not having purchased the appliance for re-sale, and 'your' has a corresponding meaning.

2. This warranty only applies to Appliances purchased and used in Australia or New Zealand and is in addition to (and does not exclude, restrict, or modify in any way) any non-excludable statutory warranties in Australia or New Zealand.

3. Electrolux warrants that, when dispatched from an Electrolux warehouse, the Appliance is free from defects in materials and workmanship for the Warranty Period.

4. During the Warranty Period Electrolux or its Authorised Service Centre will, at no extra charge and subject to these terms and conditions, repair or replace any parts which it considers to be defective. You agree that any replaced Appliances or parts become the property of Electrolux. This warranty does not apply to light globes, batteries, filters or similar perishable parts.

5. Parts and Appliances not supplied by Electrolux are not covered by this warranty.

6. Where you are within an Electrolux service area, this warranty covers the cost of transport of the Appliance to and from Authorised Service Centres of Electrolux and travelling costs for representatives of the Authorised Service Centre to and from your home or business. If you are outside an Electrolux service area, you will bear these costs. For information about whether you are within an Electrolux service area, please phone 13 13 49 in Australia, or 0800 10 66 10 in New Zealand.

7. Proof of purchase is required before you can make a claim under this warranty.

8. You may not make a claim under this warranty unless the defect claimed is due to faulty or defective parts or workmanship. Electrolux is not liable in the following situations (which are not exhaustive):

(a) The Appliance is damaged by:

(i) accident

(ii) misuse or abuse, including failure to properly maintain or service

(iii) normal wear and tear

(iv) power surges, electrical storm damage or incorrect power current

(v) incomplete or improper installation

(vi) incorrect, improper or inappropriate operation

(vii) insect or vermin infestation.

(b) The Appliance is modified without authority from Electrolux in writing.

(c) The Appliance's serial number or warranty seal has been removed or defaced.

(d) The Appliance was serviced or repaired by anyone other than Electrolux or its Authorised Service Centres.

9. This warranty, the contract to which it relates and the relationship between you and Electrolux are governed by the law applicable in the Australian State where the Appliance was purchased or the law applicable in New Zealand if the Appliance was purchased in New Zealand. Where the Appliance was purchased in New Zealand for business purposes the Consumer Guarantee Act does not apply.

Limitation of Liability

10. To the extent permitted by law:

(a) Electrolux excludes all warranties other than as contained in this document;

(b) Electrolux shall not be liable for any loss or damage whether direct or indirect or consequential arising from your purchase, use or non-use of the Appliance.

11. Provisions of the Trade Practices Act and State consumer legislation in Australia, and the Consumer Guarantees Act, the Sale of Goods Act and the Fair Trading Act in New Zealand, imply warranties or conditions, or impose obligations, upon Electrolux which cannot be excluded, restricted or modified. To the extent permitted by law, the liability of Electrolux (if any) arising out of or in relation to the Appliance or any services supplied by Electrolux shall be limited (where it is fair and reasonable to do so):

(a) in the case of Appliances, at its option, to the replacement or repair of the Appliances or the supply of equivalent products or the payment of the cost of replacing the Appliances or having the Appliances repaired or of acquiring equivalent Appliances. Upon being replaced, parts and Appliances become the property of Electrolux; or

(b) in the case of services, at its option, to the supply of the services again or the payment of the cost of having the services re-supplied;

and in the case of Appliances or services supplied in New Zealand, loss or damage whether direct or indirect or consequential that is reasonably foreseeable.

Privacy

You acknowledge that in the event that you make a warranty claim it will be necessary for Electrolux and its Authorised Service Centres to exchange information in relation to you to enable Electrolux to meet its obligations under this warranty.

Important Notice

Before Calling a Service Technician please check carefully the operating instructions, service booklet and the warranty terms and conditions.

<p>FOR SERVICE</p> <p>OR TO FIND THE ADDRESS OF YOUR NEAREST STATE SERVICE CENTRE IN AUSTRALIA</p> <p>Please call 13 13 49</p> <p>For the cost of a local call (Australia only)</p>	<p>SERVICE AUSTRALIA</p> <p></p> <p>ELECTROLUX HOME PRODUCTS</p>	<p>FOR SPARE PARTS</p> <p>OR TO FIND THE ADDRESS OF YOUR NEAREST STATE SPARE PARTS CENTRE IN AUSTRALIA</p> <p>Please call 13 13 50</p> <p>For the cost of a local call (Australia only)</p>
<p>FOR SERVICE</p> <p>OR TO FIND THE ADDRESS OF YOUR NEAREST AUTHORISED SERVICE CENTRE IN NEW ZEALAND</p> <p>Free call 0800 10 66 10 (New Zealand only)</p>	<p>NEW ZEALAND SPARE PARTS CENTRES</p> <p>AUCKLAND Prime Distributors Ltd. 8 Highbrook Drive, East Tamaki, (09) 273 3580 WELLINGTON Prime Distributors Ltd. 68 Victoria Street, Petone, (04) 586 2150 CHRISTCHURCH Prime Distributors Ltd. Unit 1, 127 Montreal Street, (03) 377 1009 R. Redpath Ltd. 55 Ferry Road, (03) 379 0446 DUNEDIN South City Champion, 590 Hillside Road, (03) 455 5443</p>	
<p></p>		<p>ELECTROLUX HOME PRODUCTS</p>

Service

In the event of technical faults, please first check whether you can remedy the problem yourself with the help of the operating instructions (section “What to do if...”).

If you were not able to remedy the problem yourself, please contact the Customer Care Department or one of our service partners.

In order to be able to assist you quickly, we require the following information:

- Model description
- Product number (PNC)
- Serial number (S No.)
(for numbers see rating plate)
- Type of fault
- Any error messages displayed by the appliance
- three digit letter-number combination for glass ceramic

So that you have the necessary reference numbers from your appliance at hand, we recommend that you write them in here:

Model description:

PNC:

S No:

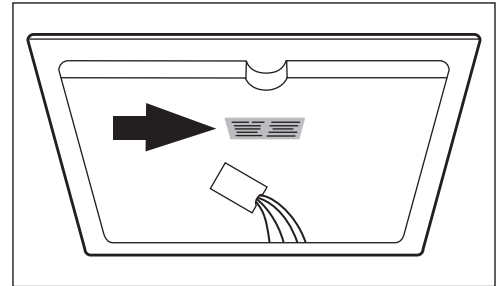

822 925 338-A-200705-02

Subject to change without notice

 **The Electrolux Group. The world's No. 1 choice.**

The Electrolux Group is the world's largest producer of powered appliances for kitchen, cleaning and outdoor use. More than 55 million Electrolux Group products (such as refrigerators, cookers, washing machines, vacuum cleaners, chain saws and lawn mowers) are sold each year to a value of approx. USD 14 billion in more than 150 countries around the world.