



user manual

Induction hob

Electrolux. Thinking of you.  
Share more of our thinking at [www.electrolux.com](http://www.electrolux.com)

## Contents

---

Safety instructions.....	3	Disposal .....	19
Description of the Appliance .....	4	Installation Instructions .....	20
Operating the appliance.....	6	Assembly .....	21
Tips on Cooking and Frying .....	14	Guarantee/Customer Service .....	25
Cleaning and Care .....	16	Service.....	27
What to do if ... ..	17		



Subject to change without notice

The following symbols are used in this user information:

 Warning! This must be read! Important advice for the safety of persons and information on avoiding damage to the appliance

 General information and advice

 Information on environmental protection

 Dangerous voltage

## Safety instructions

Please comply with these instructions. If you do not, any damage resulting is not covered by the warranty.

### Correct use

- This appliance is not intended for use by persons (including children) with reduced physical, sensory or mental capabilities, or lack of experience and knowledge, unless they have been given supervision or instruction concerning use of the appliance by a person responsible for their safety"
- Do not leave the appliance unattended during operation.
- This appliance should be used only for normal domestic cooking and frying of food.
- The appliance must not be used as a work surface or as a storage surface.
- Additions or modifications to the appliance are not permitted.
- Do not place or store flammable liquids, highly inflammable materials or fusible objects (e.g. plastic film, plastic, aluminium) on or near the appliance.

### Children's safety

- The cooking zones will become hot when you cook. Therefore, always keep small children away from the appliance.
- The appliance is not intended for use by young children or infirm persons without supervision.
- Children should be supervised to ensure they do not play with the appliance.
- To avoid small children and pets unintentionally switching the appliance on, we recommend activation of the child safety device.

### General safety

- The appliance may only be installed and connected by trained, registered service engineers.
- Built-in appliances may only be used after they have built in to suitable built-in units and work surfaces that meet standards.
- This appliance is not intended to be operated by means of an external timer or separate remote control system.

- In the event of faults with the appliance or damage to the glass ceramic (cracks, scratches or splits), the appliance must be switched off and disconnected from the electrical supply, to prevent the possibility of an electric shock.
- Repairs to the appliance must only be carried out by trained registered service engineers.

### Safety during use

- Remove stickers and film from the glass ceramic.
- There is the risk of burns from the appliance if used carelessly.
- Cables from electrical appliances must not touch the hot surface of the appliance or hot cookware.
- Overheated fats and oils can ignite very quickly. Warning! Fire hazard!
- Switch the cooking zones off after each use.
- Users with implanted pacemakers should keep their upper body at least 30 cm from induction cooking zones that are switched on.
- Risk of burns! Do not place objects made of metal, such as knives, forks, spoons and saucepan lids on the cooking surface, as they can get hot.
- After use, switch off the hob by its control, do not rely on the pot detector.

### Safety when cleaning

- For cleaning, the appliance must be switched off and cooled down.
- For safety reasons, the cleaning of the appliance with steam jet or high-pressure cleaning equipment is not permitted.

### How to avoid damage to the appliance

- The glass ceramic can be damaged by objects falling onto it.
- The edge of the glass ceramic can be damaged by being knocked by the cookware.
- Cookware made of cast iron, cast aluminium or with damaged bottoms can scratch the glass ceramic if pushed across the surface.

#### 4 electrolux

- Objects that melt and things that boil over can burn onto the glass ceramic and should be removed straightaway.
- Do not use the cooking zones with empty cookware or without cookware.
- To avoid damaging cookware and glass ceramics, do not allow saucepans or frying pans to boil dry.
- The ventilation gap of 5 mm between the worktop and front of the unit underneath it must not be covered.

## Description of the Appliance

---

### Cooking surface layout

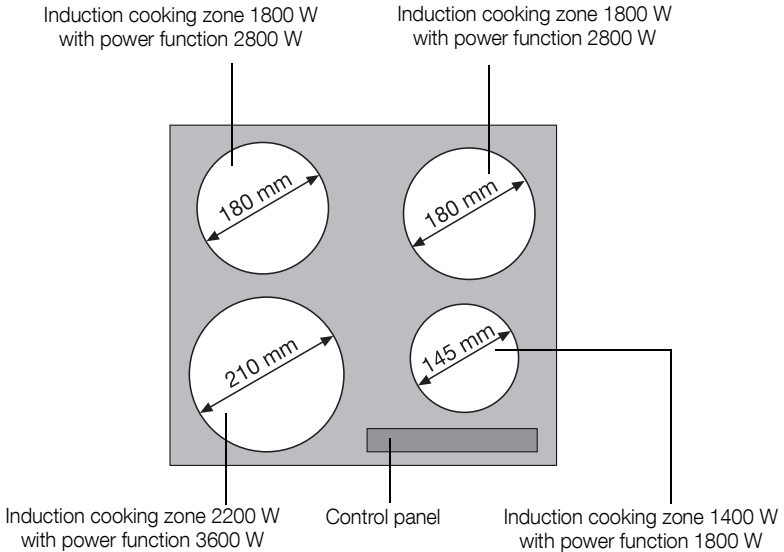

### Control panel layout

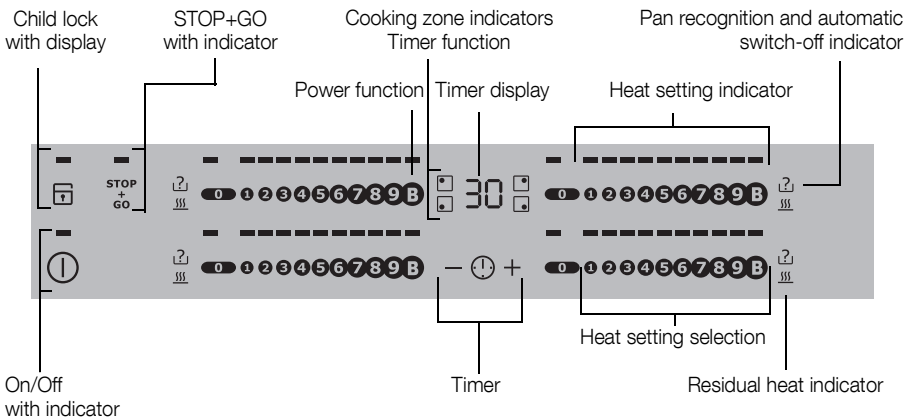





## Touch Control sensor fields

The appliance is operated using Touch Control sensor fields. Functions are controlled by touching sensor fields and confirmed by displays and acoustic signals.



Touch the sensor fields from above, without covering other sensor fields.

Sensor field	Function	
	On / Off	To switch the appliance on and off
	Lock	Locking/unlocking the control panel
	Stop+Go	To switch the Keep Warm setting on/off
	Cooking zone Off	To switch off the cooking zone
	Heat settings	To set heat settings
	Power	Switching the power function on and off
	Timer	Timer selection
	Increase settings	To increase Timer time
	Reduce settings	To reduce Timer time

## Displays

Display	Description	
	Residual heat	Cooking zone is still hot
	Fault	Malfunction has occurred
	Pan detection	Cookware is unsuitable or too small or no cookware has been placed on the cooking zone
	Automatic switch off	Switch off is active.

## Residual heat indicator

 **Warning:** Risk of burns from residual heat. After being switched off, the cooking zones take some time to cool down. Look at the residual heat indicator .

## Control bar

The heat setting and the power function are set via the control bar. The heat setting indicator consists of a chain of light elements.

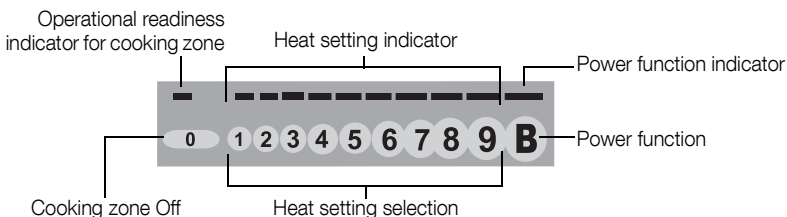

**i** If the control bar is touched for longer than 6 seconds, a signal sounds and the appliance switches itself off.

The **induction cooking zones** create the heat required for cooking directly in the base of the cookware. The glass ceramic is merely heated by the residual heat of the cookware. The **cooling fan** switches itself on and off depending upon the temperature of the electronics.

## Operating the appliance

**i** Use the induction cooking zones with suitable cookware.

## Switching the appliance on and off

	Control panel	Display
To switch on	Touch <b>ⓘ</b> for 1 second	lights up. The operational readiness indicators of the individual cooking zones also light up.
To switch off	Touch <b>ⓘ</b> for 1 second	goes out. The operational readiness indicators of the individual cooking zones also go out.

**i** After switching on, within approx. 10 seconds a heat setting or a function must be set, otherwise the appliance automatically switches itself off.

## Setting the heat setting

The control bar is touched where the desired heat setting is positioned. The heat setting is shown in the display. Correct to the left or the right, if necessary.

Do not release before the desired heat setting is reached.

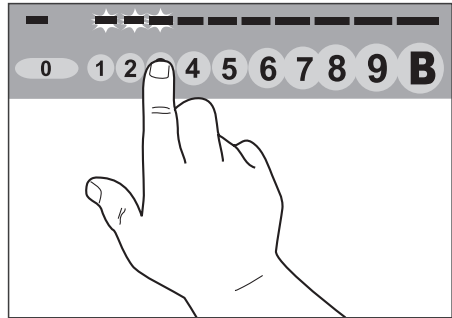

## Locking/unlocking the control panel

The control panel, with the exception of the "On/Off" sensor field, can be locked at any time in order to prevent the settings being changed e.g. by wiping over the panel with a cloth.

	Control panel	Display
To switch on	Touch	lights up
To switch off	Touch	goes out

**i** When you switch the appliance off, the locking function is automatically switched off.

## Turning the STOP+GO function on and off

The STOP+GO function simultaneously toggles all active cooking zones to keep-warm mode then back to the heat setting they were at before.

	Control panel	Display
To switch on	Touch	Keep-warm setting
To switch off	Touch	Previous heat setting (not automatic warm-up or power function)

**i** STOP+GO does not stop timer functions.

**i** STOP+GO controls the entire control panel apart from the sensor field .

## Using the automatic warm-up function

All cooking zones are equipped with an automatic warm-up function. When setting a heat setting using the automatic warm-up function, the cooking zone switches to full power for a certain amount of time and then automatically switches back to the heat setting set.

Step	Control panel	Display
1.	Select warm-up setting <b>B</b>	<b>B</b> display flashes
2.	Select the desired heat setting between 1 and 8	The desired heat setting is displayed. <b>B</b> display lights up. As long as the <b>B</b> display is lit, the appliance is working at full power. After the automatic warm-up is completed, the <b>B</b> display goes out.

The length of time that the automatic warm up function operates depends on the heat setting selected.



Heat setting	Warm-up time [min:sec]
1	0:10
2	0:10
3	3:10
4	5:50
5	10:10
6	2:00
7	2:30
8	2:50
9	---



## Using the child safety device



The child safety device prevents unintentional use of the appliance.

### Switching on the child safety device

Step	Control panel	Pilot light
1.	ⓘ Switch on appliance. (Do not set a heat setting.)	lights up. The operational readiness indicators of the individual cooking zones light up.
2.	Touch  for 4 seconds	over  lights up

The child safety device is switched on

### Switching off the child safety device

Step	Control panel	Pilot light
1.	ⓘ Switch on appliance. (Do not set a heat setting.)	above  lights up
2.	Touch  for 4 seconds	above  goes out
3.	Switch appliance off.	

The child safety device is switched off.

 The child safety device can only be switched on and off, if no heat setting is set.

### Overriding the child safety device

The child safety device can be switched off in this way for a single cooking session; it remains activated afterwards.

Step	Control panel	Pilot light
1.	ⓘ Switch appliance on	over  lights up
2.	Touch  for 4 seconds	over  goes out.

Until the appliance is next switched off, it can be used as normal. The child safety device is still active after switching off.

 After overriding the child safety device, a heat setting or a function must be set within approx. 10 seconds, otherwise the appliance automatically switches itself off.

## Switching the power function on and off

The power function **B** makes more power available to the induction cooking zones, e.g. to bring a large quantity of water to the boil quickly.

The power function is activated for 10 minutes at most. After that the induction cooking zone automatically switches back to heat setting 9.

	Control panel	Display
To switch on	Touch <b>B</b>	The light elements in the control bar light up. The <b>B</b> display flashes
To switch off	Select the heat setting 1-9	The heat setting selected is shown in the display. The display above <b>B</b> will go out.

**i** If the power function has ended, the cooking zones automatically switch back to the heat setting set previously.

### Power Management

The cooking zones of the cooking surface have a maximum power.

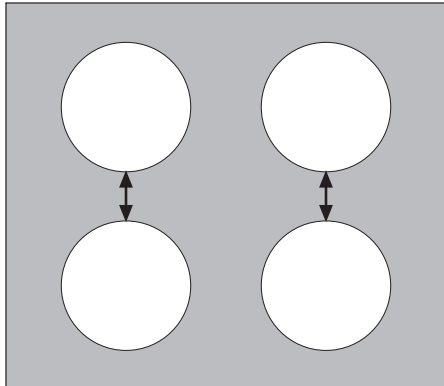

The maximum power is reached when the heat setting 9 has been set for all cooking zones.

Two cooking zones generate a pair (see figure) and therefore, the power management shares the maximum available power between these cooking zones.

When the power function is selected for one cooking zone, the power management makes the additional power for this cooking zone available by reducing the power of the corresponding other cooking zone.

Example: the heat setting 9 is selected on one cooking zone. The power function is switched on for the corresponding cooking zone. The power function is carried out but the heat setting 9 of one of the cooking zones and the power function for the other cooking zone of the pair exceed the maximum power for both at the same time. For this purpose, the power management reduces the power of the cooking zone that switched on first from 9 to example 5 and the display of this cooking zone changes between 9 and 5 and then stays at the current possible maximum 5. (If the display changes between 9 and 5 or 9 and 3 or another value depends on the type of appliance and the size of the cooking zone.).







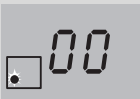

## Using the timer

Function	Condition	Outcome after the time has elapsed
<b>Automatic cut-out</b>	a heat setting is set	acoustic signal 00 flashes Cooking zone switches off
<b>Countdown timer</b>	cooking zones not in use	acoustic signal 00 flashes

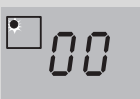
- i** If just one countdown value is set you can change it only when the appliance is switched on.
- i** If a heat setting is set on this cooking zone in addition to a countdown timer, the cooking zone is switched off after the time set has elapsed.
- i** If a cooking zone is switched off, the timer function set is also switched off.

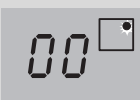
### Selecting a cooking zone

Step	Control panel	Display
1.	Touch  once	Pilot light of the first cooking zone flashes 
2.	Touch  once	Pilot light of the second cooking zone flashes 
3.	Touch  once	Pilot light of the third cooking zone flashes 
4.	Touch  once	Pilot light of the fourth cooking zone flashes 

- i** If other timer functions are set, after a few seconds the shortest remaining time of all the timer functions is displayed and the corresponding pilot light flashes.

## Setting the time

Step	Control panel	Indicator
1.	Select  cooking zone	Pilot light for the cooking zone selected flashes
2.	Touch + or -	<b>00</b> to <b>99</b> minutes

After a few seconds the pilot light flashes more slowly.  
The time is set.  
The time counts down.

## Switching off the timer function

Step	Control panel	Indicator
1.	Select  cooking zone	Pilot light of cooking zone selected flashes faster Time remaining is displayed
2.	Touch -	The time remaining counts backwards to <b>00</b> .

The pilot light goes out.  
The Timer function for the selected cooking zone is switched off.

## Changing the time

Step	Control panel	Indicator
1.	Select  cooking zone	Pilot light of the selected cooking zone flashes faster Time remaining is displayed
2.	Touch + or -	<b>01</b> to <b>99</b> minutes

After a few seconds, the pilot light flashes more slowly.  
The time is set.  
The time counts down.

## Displaying the time remaining for a cooking zone

Step	Control panel field	Display
1.	 Select cooking zone	Pilot light of the cooking zone selected flashes faster The time remaining is displayed

After a few seconds the pilot light flashes more slowly.

## Switching off the acoustic signal

Step	Control panel field	Acoustic signal
1.	Touch 	Acoustic signal to acknowledge.

Acoustic signal stops.

## Automatic switch off





### Cooking surface

- If after switching on the cooking surface, a heat setting is not set for a cooking zone within approx. 10 seconds, the cooking surface automatically switches itself off.
- If one or more sensor fields are covered by objects (a pan, etc.) for longer than approx. 10 seconds, a signal sounds and the cooking surface switches off automatically.
- If all cooking zones are switched off, the cooking surface automatically switches itself off after approx. 10 seconds.

### Control panel

- When the appliance is switched off, if one or more of the sensor fields on the control panel are covered for more than 10 seconds, an acoustic signal sounds. The acoustic signal switches itself off automatically when the sensor fields are no longer covered.

### Induction cooking zones

- In the case of overheating (e.g. when a saucepan boils dry) the cooking zone automatically switches itself off.  is displayed. Before being used again, the cooking zone must be set to  and cooled down.
- If cookware that is not suitable is used,  lights up in the display and after 2 minutes the indicator for the cooking zone switches itself off.
- If one of the cooking zones is not switched off after a certain time, or if the heat setting is not modified, the relevant cooking zone switches off automatically.  is displayed. Before being used again, the cooking zone must be set to



Heat setting	Switches off after
1 - 2	6 hours
3 - 4	5 hours
5	4 hours
6 - 9	1.5 hours

## Tips on Cooking and Frying

### **i** Information on acrylamides

According to the latest scientific knowledge, intensive browning of food, especially in products containing starch, can constitute a health risk due to acrylamides. Therefore we recommend cooking at the lowest possible temperatures and not browning foods too much.

## Cookware for induction cooking zones

### Cookware material

Cookware material	suitable
Cast iron	+
Steel, enamelled steel	+
Stainless steel	+*
Multi-layer pan bottom	+*
Aluminium, copper, brass	-
Glass, ceramic, porcelain	-

**i** \* Cookware for induction cooking zones is labelled as suitable by the manufacturer.

### Suitability test

Cookware is suitable for induction cooking, if ...

- ... a little water on an induction cooking zone set to heat setting 9 is heated very quickly.
- ... a magnet sticks to the bottom of the cookware.

### Cookware base

The bottom of the cookware should be as thick and flat as possible.

### Pan size

Up to a certain limit, induction cooking zones adapt themselves to the size of the bottom of the cookware automatically. However, depending on the cooking zone size, the magnetic part of the bottom of the cookware must have a minimum diameter.

Diameter of cooking zone [mm]	Minimum diameter of dish base [mm]
210	180
180	145
145	120

**i** The cookware must be placed centrally on the cooking zone.

## Tips on energy saving

- 🔥** Place cookware on the cooking zone before it is switched on.
- 🔥** If possible, always place a lid on the cookware.

## Examples of cooking applications

The information given in the following table is for guidance only.

Heat setting	Cooking-process	suitable for	Cooking time	Tips/Hints
0		Off position		
1	<b>Keeping food warm</b>	Keeping cooked foods warm	as required	Cover
1-2	<b>Melting</b>	Hollandaise sauce, melting butter, chocolate, gelatine	5-25 mins.	Stir occasionally
	<b>Solidifying</b>	Fluffy omelettes, baked eggs	10-40 mins.	Cook with lid on
2-3	<b>Simmering on low heat</b>	Simmering rice and milk-based dishes Heating up ready-cooked meals	25-50 mins.	Add at least twice as much liquid as rice, stir milk dishes part way through cooking
3-4	<b>Steaming Braising</b>	Steaming vegetables, fish braising meat	20-45 mins.	With vegetables add only a little liquid (a few table-spoons)
4-5	<b>Boiling</b>	Steaming potatoes	20-60 mins.	Use only a little liquid, e. g.: max. $\frac{1}{4}$ l water for 750 g potatoes
		Cooking larger quantities of food, stews and soups	60-150 mins.	Up to 3 l liquid plus ingredients
6-7	<b>Gentle Frying</b>	Frying escalopes, veal cordon bleu, cutlets, rissoles, sausages, liver, roux, eggs, pancakes, doughnuts	Steady frying	Turn halfway through cooking
7-8	<b>Heavy Frying</b>	Hash browns, loin steaks, steaks, Flädle (pancakes for garnishing soup)	5-15 mins. per pan	Turn halfway through cooking
9	<b>Boiling Searing Deep frying</b>	Boiling large quantities of water, cooking pasta, searing meat (goulash, pot roast), deep frying chips		

The power function is suitable for heating large quantities of liquid.

## Cleaning and Care

 **Take care!** Risk of burns from residual heat.

 **Warning!** Sharp objects and abrasive cleaning agents can damage the appliance by scratching the glass surface, which may result in shattering of glass. Clean the appliance and remove the residues with water and washing up liquid after each use. Remove also remnants of cleaning agents!

### Cleaning the appliance after each use

1. Wipe the appliance with a damp cloth and a little washing up liquid.
2. Rub the appliance dry using a clean cloth.

### Removing deposits

1. Place a scraper on the glass ceramic surface at an angle.
2. Remove residues by sliding the blade over the surface.
3. Wipe the appliance with a damp cloth and a little washing up liquid.
4. Rub the appliance dry using a clean cloth.

Type of dirt	Remove		
	immediately	when the appliance has cooled down	using
sugar, food containing sugar	yes	---	a scraper*
plastics, tin foil	yes	---	
limescale and water rings	---	yes	cleaner for glass ceramic or stainless steel*
fat splashes	---	yes	
shiny metallic discolouration	---	yes	

\*Scrapers and cleaners for glass ceramic and stainless steel can be purchased in specialized shops

 Remove stubborn residues with a cleaner for glass ceramic or stainless steel.

 Scratches or dark stains on the glass ceramic that cannot be removed do not however affect the functioning of the appliance.





## What to do if ...

Problem	Possible cause	Remedy
The appliance cannot be switched on or is not operating	More than 10 seconds have passed since the appliance was switched on	Switch the appliance on again.
	The lock is switched on	Switch off the lock (See the section "Locking/unlocking the control panel")
	The child safety device is switched on	Deactivate child safety device (See the section "Child safety device")
	Several sensor fields were touched at the same time	Only touch one sensor field
	Automatic switch off has been triggered	Remove any objects (pan, cloths, etc.) that are lying on the control panel. Switch the appliance on again
	Dirty control panel	The sensor fields must be dry and fat-free.
The residual heat indicator is not displaying anything	The cooking zone was only on for a short time and is therefore not hot	If the cooking zone is supposed to be hot, call the Customer Service Department.
Repeated acoustic signal (6x), appliance switches off	One or more sensor fields have been covered for longer than 10 seconds	Uncover sensor field
Acoustic signal sounds when appliance is switched off	The control panel is wholly or partly covered by objects.	Remove objects.
Acoustic signal sounds and appliance switches itself on and then off again; after 5 seconds another acoustic signal sounds	The On/Off sensor field has been covered up, e.g. by a cloth	Do not place any objects on the control panel
Display is switching between two heat settings	Power management is reducing the power of this cooking zone	See the section "Switching the power function on and off"
🔍 lights up	Unsuitable cookware	Use suitable cookware
	No cookware on the cooking zone	Place cookware on the cooking zone
	The diameter of the bottom of the cookware is too small for the cooking zone	Move onto a smaller cooking zone Use suitable cookware
🔍 lights up	Overheating protection for the cooking zone has been triggered	Switch off the cooking zone. Switch the cooking zone on again
	Automatic switch-off has been triggered	Switch appliance off. Switch appliance on again

Problem	Possible cause	Remedy
E and number are displayed	Electronics fault	Disconnect the appliance from the electrical supply for a few minutes (Take the fuse out of the house's wiring system) If after switching on again, E is displayed again, call the customer service department

**If you are unable to remedy the problem by following the above suggestions, please contact your local Service Force Centre.**

 **Warning!** Repairs to the appliance are only to be carried out by qualified service engineers. Considerable danger to the user may result from improper repairs.

 If the appliance has been operated incorrectly, the engineer's visit will be chargeable, even during the warranty period.

### Operating noises

Depending on the material and the processing of the base, the following noises may occur when using induction cooking zones.

- Cracking noise (1)  
when using cookware made of different materials (Sandwich construction)
- Whistling (1)  
when using an individual cooking zone or several cooking zones with high powers when the cookware is made of different materials (Sandwich construction)
- Humming (2)  
can occur at high power levels
- Clicking (2)  
during electric switching processes
- Hissing, buzzing (3)  
The device is fitted with a fan for cooling the electrics. A whirling noise can be heard when operating the fan which may deviate depending on the performance and may continue for a while after the appliance is switched off.

**The noises described are normal and do not refer to any defects.**

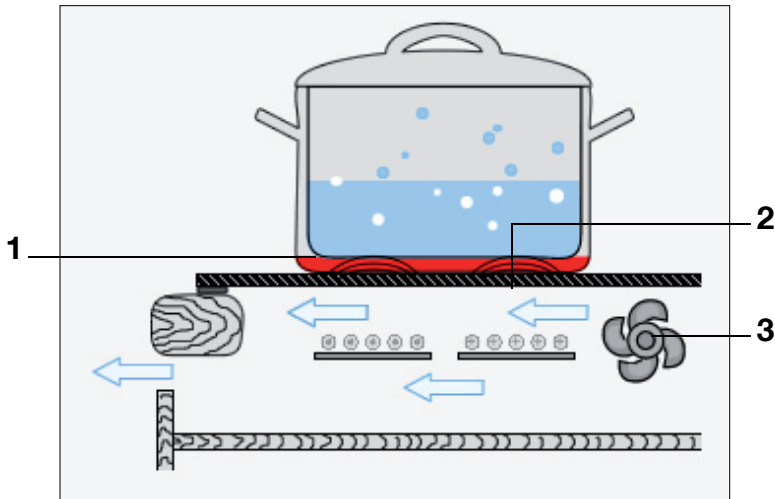

## Disposal



### Packaging material

The packaging materials are environmentally friendly and can be recycled. The plastic components are identified by markings, e.g. >PE<, >PS<, etc. Please dispose of the packaging materials in the appropriate container at the community waste disposal facilities.



### Old appliance

The symbol  on the product or on its packaging indicates that this product may not be treated as household waste. Instead it shall be handed over to the applicable collection point for the recycling of electrical and electronic equipment. By ensuring this product is disposed of correctly, you will help prevent potential negative consequences for the environment and human health, which could otherwise be caused by inappropriate waste handling of this product. For more detailed information about recycling of this product, please contact your local city office, your household waste disposal service or the shop where you purchased the product.

## Installation Instructions

### Safety instructions

Warning! This must be read!

The laws, ordinances, directives and standards in force in the country of use are to be followed (safety regulations, proper recycling in accordance with the regulations, etc.) Installation may only be carried out by a qualified electrician.

The minimum distances to other appliances and units are to be observed.

Anti-shock protection must be provided by the installation, for example drawers may only be installed with a protective floor directly underneath the appliance.

The cut surfaces of the worktop are to be protected against moisture using a suitable sealant.

The sealant seals the appliance to the work top with no gap.

When building in, protect the underside of the appliance from steam and moisture, e.g. from a dishwasher or oven.

Avoid installing the appliance next to doors and under windows. Otherwise hot cookware may be knocked off the rings when doors and windows are opened.

#### Risk of injury from electrical current.

- The electrical mains terminal is live.
- Make electrical mains terminal free of voltage.
- Follow connection schematic.
- Observe electrical safety rules.
- Ensure anti-shock protection by installing correctly.
- The appliance must be connected to the electrical supply by a qualified electrician.

#### Risk of injury from electrical current.

- Loose and inappropriate plug and socket connections can make the terminal overheat.
- Have the clamping connections correctly installed by a qualified electrician.
- Use strain relief clamp on cable.
- CAUTION: The surface temperature exceeds 95°C. To avoid a hazard, under-bench access must be restricted.
- Supply cords must have a temperature rating not less than 105°C.
- The ventilation gap requirement of 5mm underneath the cooktop must be observed.

## Electrical Connection

Before connecting, check that the nominal voltage of the appliance, that is the voltage stated on the rating plate, corresponds to the available supply voltage. Also check the power rating of the appliance and ensure that the wire is suitably sized in accordance with local wiring rules. The rating plate is located on the lower casing of the hob.

The heating element voltage is AC230V~.

The appliance also works perfectly on networks with AC220V~ or AC240V~. Means for disconnection must be incorporated in the fixed wiring in accordance with local wiring rules.

The hob is to be connected to the mains using a device that allows the appliance to be disconnected from the mains at all poles with a contact opening width of at least 3 mm, eg. automatic line protecting cut-out, earth leakage trips or fuse.

If this appliance's mains cable is damaged, it must be replaced by a special cable (type H05BB-F Tmax 90°C; or higher). The latter is available from the Customer Care Department. The connection must be carried out as shown in the diagram, refer to the sticker on the back of the hob for wiring connection diagram. The connecting links should be fitted according to the appropriate connection diagram. Note for single phase connection, the link (or bridge) will need to be fitted between terminals 1 & 2 (refer to the connection sticker on back of the unit). The earth lead is connected to terminal . The earth lead must be longer than leads carrying electric current.

#### **The cable connections must be made in accordance with regulations and the terminal screws tightened securely.**

Finally, the connecting cable is to be secured with the mains cable cleat and the covering closed by pressing firmly (lock into place). Before switching on for the first time, any protective foil or stickers must be removed from the glass ceramic surface.

-  Once connected to the mains supply check that all cooking zones are ready for use by briefly switching each on in turn at the maximum setting.

A duplicate rating label is supplied with this unit. For easy identification of this unit after installation, stick it to a readily available surface adjacent to the cooktop.

### Sticking on the seal

- Clean the worktop around the cut-out area.
- Stick the single-sided adhesive sealing tape provided on the underside of the hob around the outside edge ensuring that it is not stretched. The two ends of the tape should join in the middle of one side. After trimming the tape (allow it to overlap by 2-3 mm), press the two ends together.

## Assembly

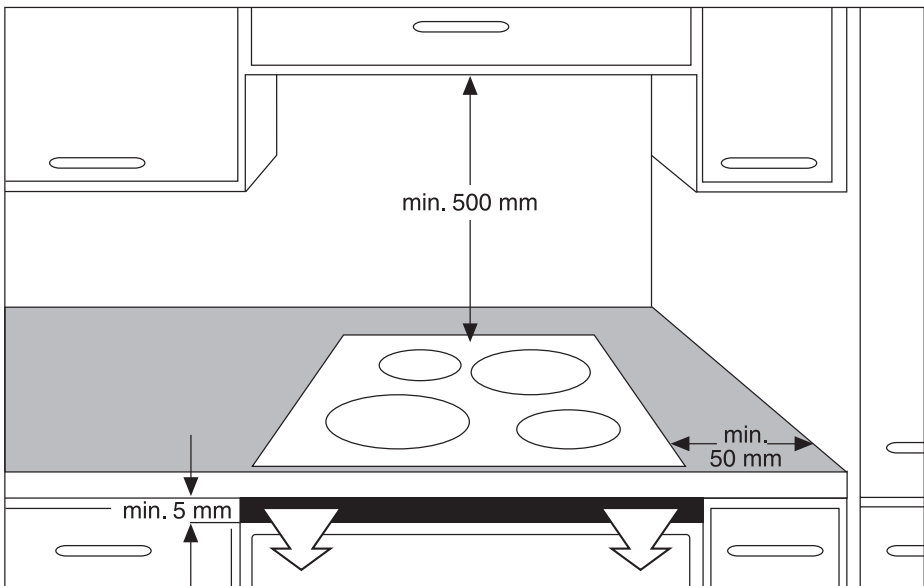
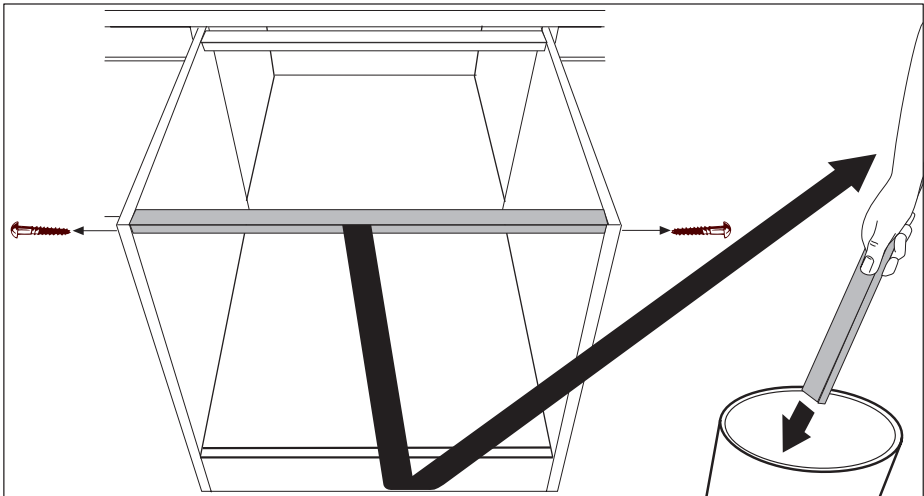

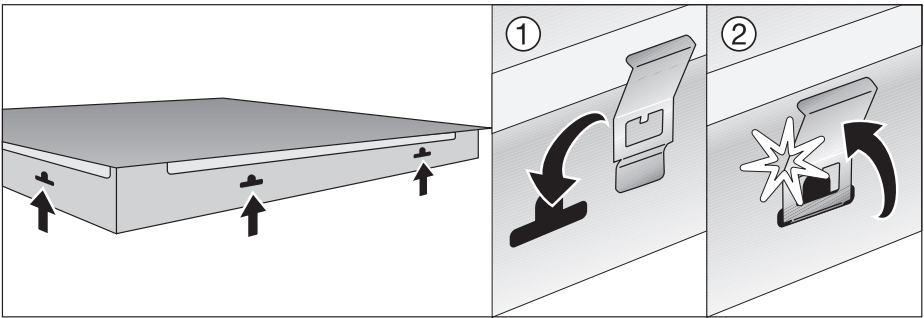
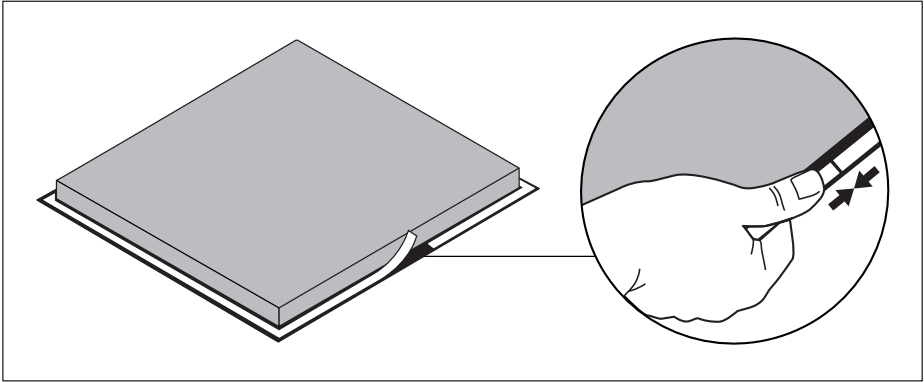

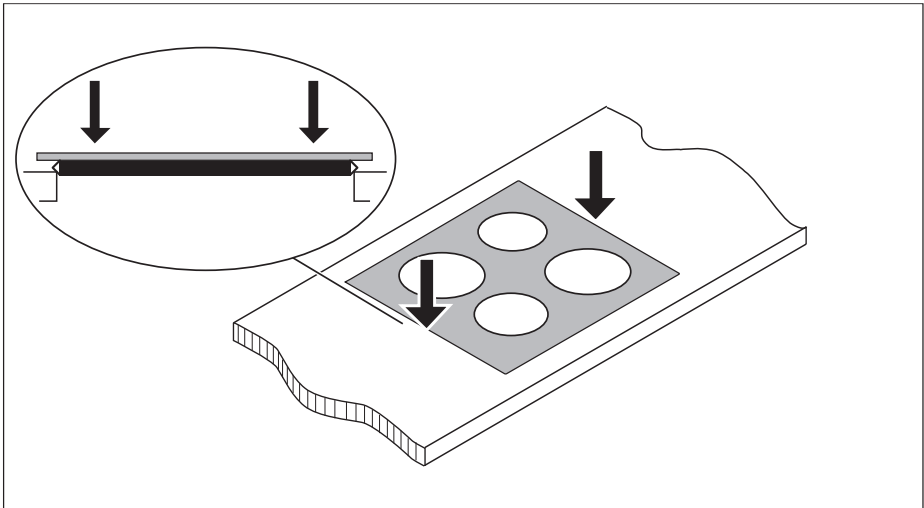
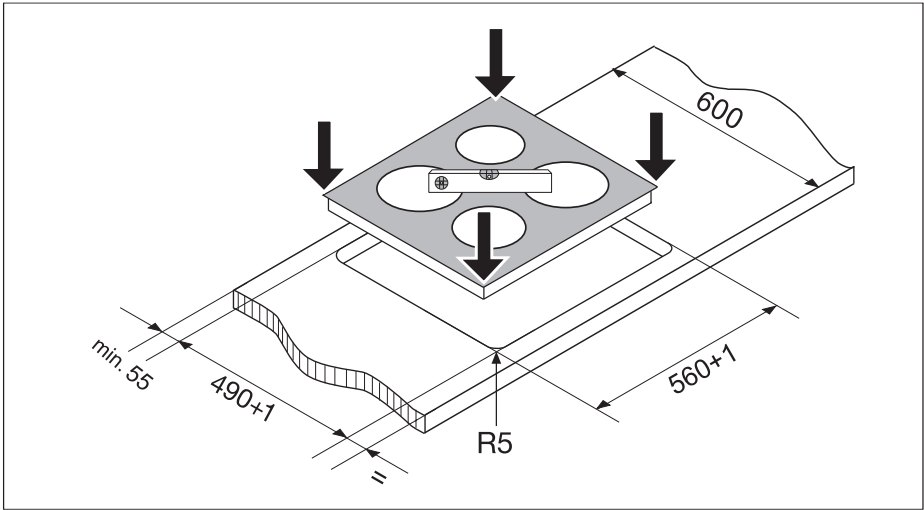

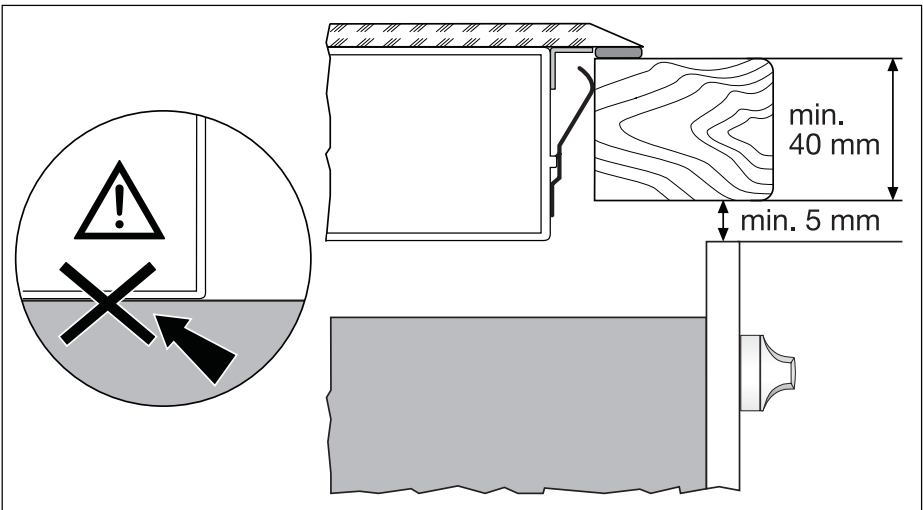
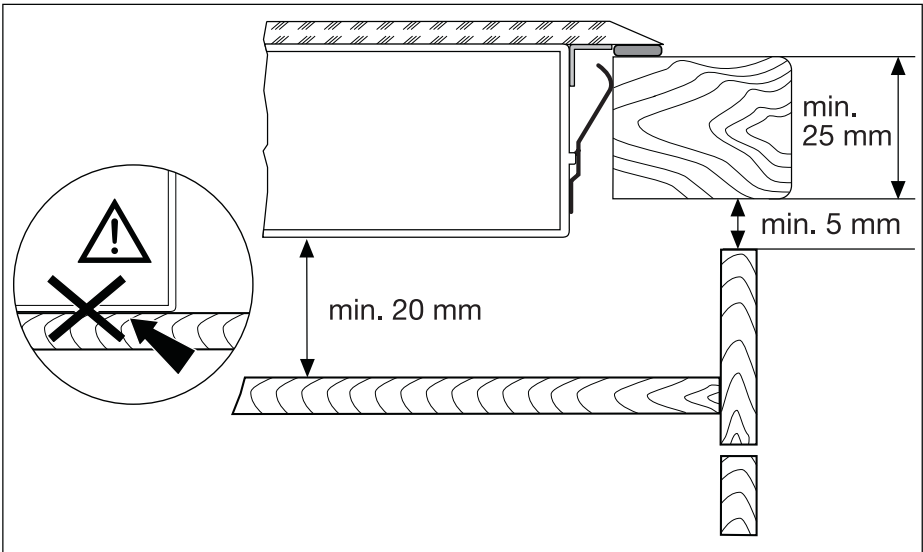

**⚠ WARNING!** Surface temperature of base exceed 95°C, under bench access must be restricted by use of non-combustible barrier on installation.

### Rating Plate

Modell EHD60150P		Prod.Nr. 949 592 880	
Typ 55GADD5AU	230 V	50 Hz	Induction 7,4 kW
Made in Germany	Ser.Nr. ....	7,4 kW	
ELECTROLUX			



## Guarantee/Customer Service

---

### **Electrolux** Warranty

---

FOR SALES IN AUSTRALIA AND NEW ZEALAND  
APPLIANCE: ELECTROLUX

This document sets out the terms and conditions of product warranties for Electrolux branded appliances. It is an important document.

Please keep it with your proof of purchase documents in a safe place for future reference should you require service for your Electrolux appliance.

#### General Terms and Conditions

##### 1. In this warranty

- (a) 'Electrolux' means Electrolux Home Products Pty Ltd ABN 51004 762 341 in respect of Appliances purchased in Australia and Electrolux (NZ) Limited in respect of Appliances purchased in New Zealand;
- (b) 'Appliance' means any Electrolux product purchased by you accompanied by this document;
- (c) 'Warranty Period' means
  - i) where you use the Appliance for personal, domestic or household purposes in Australia the period of 24 months and in New Zealand the period of 24 months;
  - ii) where you use the Appliance for commercial purposes, in Australia the period of 3 months and in New Zealand the period of 3 months, (if the period stated is 0 months you are not covered by this product warranty) following the date of original purchase of the Appliance;
- (d) 'you' means the purchaser of the Appliance not having purchased the appliance for re-sale, and 'your' has a corresponding meaning.

2. This warranty only applies to Appliances purchased and used in Australia or New Zealand and is in addition to (and does not exclude, restrict, or modify in any way) any non-excludable statutory warranties in Australia or New Zealand.

3. Electrolux warrants that, when dispatched from an Electrolux warehouse, the Appliance is free from defects in materials and workmanship for the Warranty Period.

4. During the Warranty Period Electrolux or its Authorised Service Centre will, at no extra charge if your appliance is readily accessible without special equipment, and subject to these terms and conditions, repair or replace any parts which it considers to be defective. You agree that any replaced Appliances or parts become the property of Electrolux. This warranty does not apply to light globes, batteries, filters or similar perishable parts.

5. Parts and Appliances not supplied by Electrolux are not covered by this warranty.

6. Where you are within an Electrolux service area, this warranty covers the cost of transport of the Appliance to and from Authorised Service Centres of Electrolux and travelling costs for representatives of the Authorised Service Centre to and from your home or business. If you are outside an Electrolux service area, you will bear these costs. For information about whether you are within an Electrolux service area, please phone 13 13 49 in Australia, or 0800 10 66 10 in New Zealand.

7. Proof of purchase is required before you can make a claim under this warranty.

8. You may not make a claim under this warranty unless the defect claimed is due to faulty or defective parts or workmanship. Electrolux is not liable in the following situations (which are not exhaustive):

- (a) The Appliance is damaged by
  - i) accident
  - ii) misuse or abuse, including failure to properly maintain or service
  - iii) normal wear and tear
  - iv) power surges, electrical storm damage or incorrect power supply
  - v) incomplete or improper installation
  - vi) incorrect, improper or inappropriate operation
  - vii) insect or vermin infestation.

- (b) The Appliance is modified without authority from Electrolux in writing.
- (c) The Appliance's serial number or warranty seal has been removed or defaced.
- (d) The Appliance was serviced or repaired by anyone other than Electrolux or its Authorised Service Centres.

9. This warranty, the contract to which it relates and the relationship between you and Electrolux are governed by the law applicable in the Australian State where the Appliance was purchased or the law applicable in New Zealand if the Appliance was purchased in New Zealand. Where the Appliance was purchased in New Zealand for business purposes the Consumer Guarantee Act does not apply.

**Limitation of Liability**

10. To the extent permitted by law:

- (a) Electrolux excludes all warranties other than as contained in this document;
- (b) Electrolux shall not be liable for any loss or damage whether direct or indirect or consequential arising from your purchase, use or non-use of the Appliance.

11. Provisions of the Trade Practices Act and State consumer legislation in Australia, and the Consumer Guarantees Act, the Sale of Goods Act and the Fair Trading Act in New Zealand, imply warranties or conditions, or impose obligations, upon Electrolux which cannot be excluded, restricted or modified. To the extent permitted by law, the liability of Electrolux (if any) arising out of or in relation to the Appliance or any services supplied by Electrolux shall be limited (where it is fair and reasonable to do so):

- (a) in the case of Appliances, at its option, to the replacement or repair of the Appliances or the supply of equivalent products or the payment of the cost of replacing the Appliances or having the Appliances repaired or of acquiring equivalent Appliances. Upon being replaced, parts and Appliances become the property of Electrolux; or
- (b) in the case of services, at its option, to the supply of the services again or the payment of the cost of having the services re-supplied;

and in the case of Appliances or services supplied in New Zealand, loss or damage whether direct or indirect or consequential that is reasonably foreseeable.

**Privacy**

You acknowledge that in the event that you make a warranty claim it will be necessary for Electrolux and its Authorised Service Centres to exchange information in relation to you to enable Electrolux to meet its obligations under this warranty.

**Important Notice**

Before Calling a Service Technician please check carefully the operating instructions, service booklet and the warranty terms and conditions.

<p><b>FOR SERVICE</b> OR TO FIND THE ADDRESS OF YOUR NEAREST STATE SERVICE CENTRE IN AUSTRALIA <b>Please call 13 13 49</b> <small>For the cost of a local call (Australia only)</small></p>	<p><b>SERVICE AUSTRALIA</b>  <b>Electrolux</b> <b>ELECTROLUX HOME PRODUCTS</b> <small>www.electrolux.com.au</small></p>	<p><b>FOR SERVICE</b> OR TO FIND THE ADDRESS OF YOUR NEAREST STATE SPARE PARTS CENTRE IN AUSTRALIA <b>Please call 13 13 50</b> <small>For the cost of a local call (Australia only)</small></p>
<p><b>FOR SERVICE</b> OR TO FIND THE ADDRESS OF YOUR NEAREST AUTHORISED SERVICE CENTRE IN NEW ZEALAND <b>Free call 0800 10 66 10</b> <small>(New Zealand only)</small></p>	<p><b>SERVICE NEW ZEALAND</b>  <b>Electrolux</b> <b>ELECTROLUX HOME PRODUCTS</b> <small>www.electrolux.co.nz</small></p>	<p><b>FOR SPARE PARTS</b> OR TO FIND THE ADDRESS OF YOUR NEAREST SPARE PARTS CENTRE IN NEW ZEALAND <b>Free call 0800 10 66 20</b> <small>(New Zealand only)</small></p>

## Service

---

In the event of technical faults, please first check whether you can remedy the problem yourself with the help of the operating instructions (section “What to do if...”).

If you were not able to remedy the problem yourself, please contact the Customer Care Department or one of our service partners.

In order to be able to assist you quickly, we require the following information:

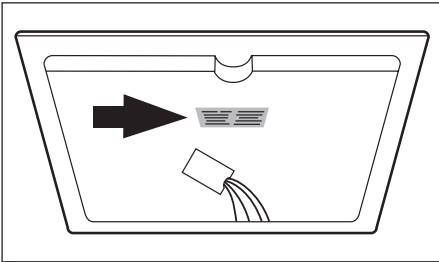

- three digit letter-number combination for glass ceramic
- Model description
- Product number (PNC)
- Serial number (S No.)  
(for numbers see rating plate)
- Type of fault
- Any error messages displayed by the appliance

So that you have the necessary reference numbers from your appliance at hand, we recommend that you write them in here:

Model description: .....

PNC: .....

S No: .....

[www.electrolux.com](http://www.electrolux.com)

[www.electrolux.com.au](http://www.electrolux.com.au)

[www.electrolux.co.nz](http://www.electrolux.co.nz)