

Electric built-in oven

# INSTRUCTION BOOKLET

 **Electrolux**

GALLERY

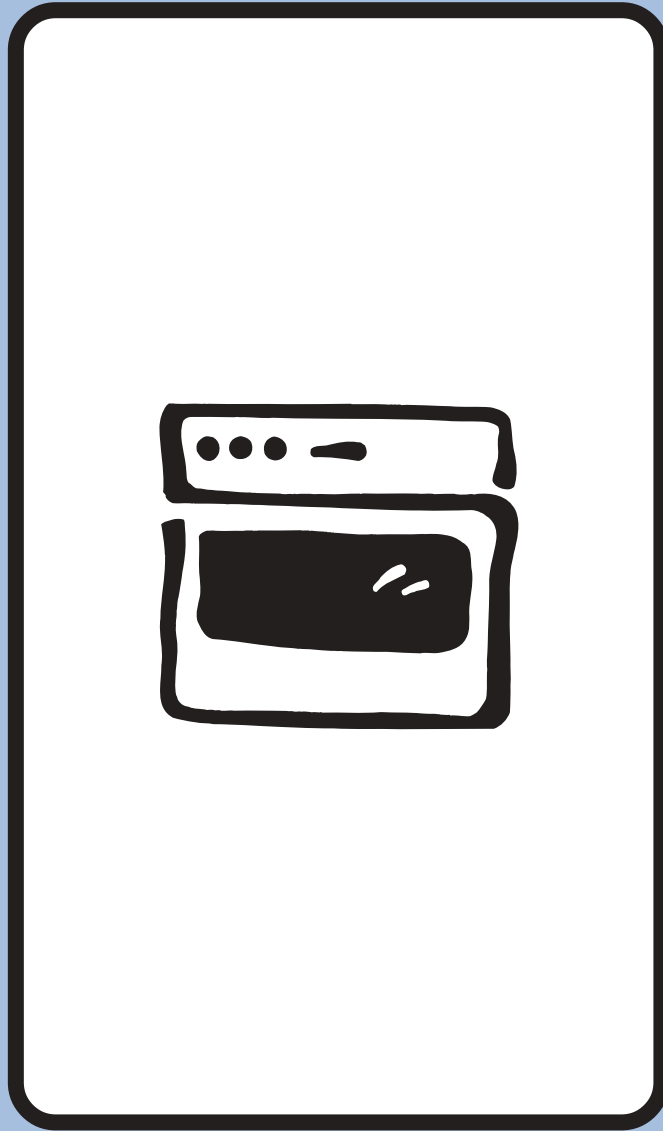

*Model EOB 6790*

# Important Safety Information

It is most important that this instruction book should be retained with the appliance for future reference. Should the appliance be sold or transferred, always ensure that the book is left with the appliance in order that the new owner can get to know the functions of the appliance and the relevant warnings. These warnings are provided in the interest of safety. You **MUST** read them carefully before installing or using the appliance.

## Installation

- This oven is heavy and care must be taken when moving it.
- Ensure that **all packaging**, both inside and outside the oven, has been **removed** before the oven is used.
- The oven must be installed according to the instructions supplied. Any electrical work must be undertaken by a qualified electrician.
- **It is dangerous** to alter the specifications in any way.
- After installation, please dispose of the packaging with due regard to safety and the environment.

## Child Safety

- The appliance is not intended for use by young children or infirm persons without supervision. Young children **must not** be allowed to tamper with the controls or play near or with the oven.
- Ovens become **very hot**, and retain their heat for a long period of time after use. Children should be kept well away from the oven until it has cooled.
- **CAUTION** - accessible parts will become hot when in use. To avoid burns and scalds children should be **kept away**.
- Appliances become very hot with use, and retain their heat for long periods after use. Care should be taken to avoid touching heating elements inside the oven.

## During Operation

- **Do not** use this oven if it is in contact with water and never operate it with wet hands.
- Ensure that the oven shelves are installed in the correct way.
- Take **great care** when heating fats and oils as they will ignite if they become too hot.
- This oven has been designed for cooking edible foodstuffs only and **must not** be used any other purposes.
- **Never** place plastic or any other material which may melt in or on the oven.
- **Only** clean this oven in accordance with the instructions.
- **Take care** to follow the recommendations given for tending the food when grilling. Use the handles provided in the recommended way.
- **Always grill with the oven door closed.**
- **Always** use oven gloves to remove and replace food in the oven.
- Ensure that you **support** the grill pan when removing it from the oven.
- **Never** line any part of the oven with aluminium foil.
- **Do not** allow heatproof cooking material, e.g. roasting bags, to come into contact with oven elements.

- **Always** stand back from the oven when opening the oven door, to allow any build-up of steam or heat to release.
- Stand clear when opening the drop down oven door.
- **Do not** allow it to fall open - support it using the door handle, until it is fully open.
- **Do not** place sealed cans or aerosols inside the oven. They may explode if they are heated.
- **Do not** hang towels or clothes from the oven or its handle. They are a **safety hazard**.

## After Use

- Ensure that the electronic programmer is in the **OFF** position when not in use.
- For hygiene and safety reasons, this oven should be kept clean at all times. A build-up of fats or other foodstuffs could result in a fire, especially in the grill pan.
- Only clean this oven in accordance with the instructions.
- Never use steam or high pressure steam cleaners to clean the appliance.
- Always allow the oven to cool down before switching off at the wall prior to carrying out any cleaning or maintenance work.
- **Do not** leave utensils containing foodstuffs, e.g. fat or oil in or on the oven in case it is inadvertently switched **ON**.
- **Under no circumstances** should you attempt to repair the appliance yourself. Repairs carried out by inexperienced persons may cause injury or serious malfunctioning. Refer to your local Service Centre. Always insist on genuine spare parts.

## Environmental Information

- After installation, please dispose of the packaging with due regard to safety and the environment.
- When disposing of an old appliance, make it unusable, by cutting off the cable. Remove any door catches, to prevent small children being trapped inside.



The symbol  on the product or on its packaging indicates that this product may not be treated as household waste. Instead it shall be handed over to the applicable collection point for the recycling of electrical and electronic equipment. By ensuring this product is disposed of correctly, you will help prevent potential negative consequences for the environment and human health, which could otherwise be caused by inappropriate waste handling of this product.

For more detailed information about recycling of this product, please contact your local city office, your household waste disposal service or the shop where you purchased the product.

# Contents

## For the User

Important Safety Information	2
Description of the Oven	4
The Oven Electronic Control	5
When the Oven is First Installed	6
Before the First use of the Oven	7
Cooking Functions	9
Programming the Oven	9
Safety and Energy Saving Functions	11
The "Recipe Selection" Function	13
Using the Oven	14
Shelf supports	14
Hints and Tips	15
The Conventional Oven	16
The Fan Oven	17
Cooking Chart-Conventional and Fan Oven	18
Grilling	19
Cooking Chart-Grilling	20
Pizza Oven	21
Defrosting	21
Cleaning the Oven	22
Something not Working	26

## For the Installer

Installation	27
Technical Data	27
Electrical Connection	28
Building In	29

## Guide to use the instructions

The following symbols will be found in the text to guide you throughout the Instructions:

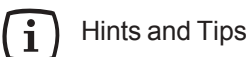

**CE** This appliance complies with the following **E.E.C. Directives:**  
\*73/23 - 90/683 (Low Voltage Directive);  
\*93/68 (General Directives);  
\*89/336 (Electromagnetical Compatibility Directive) and subsequent modifications.

**Your safety is of paramount importance. Therefore, if you are unsure about any of the meanings of these WARNINGS, contact the Customer Care Department.**

# Description of the Oven

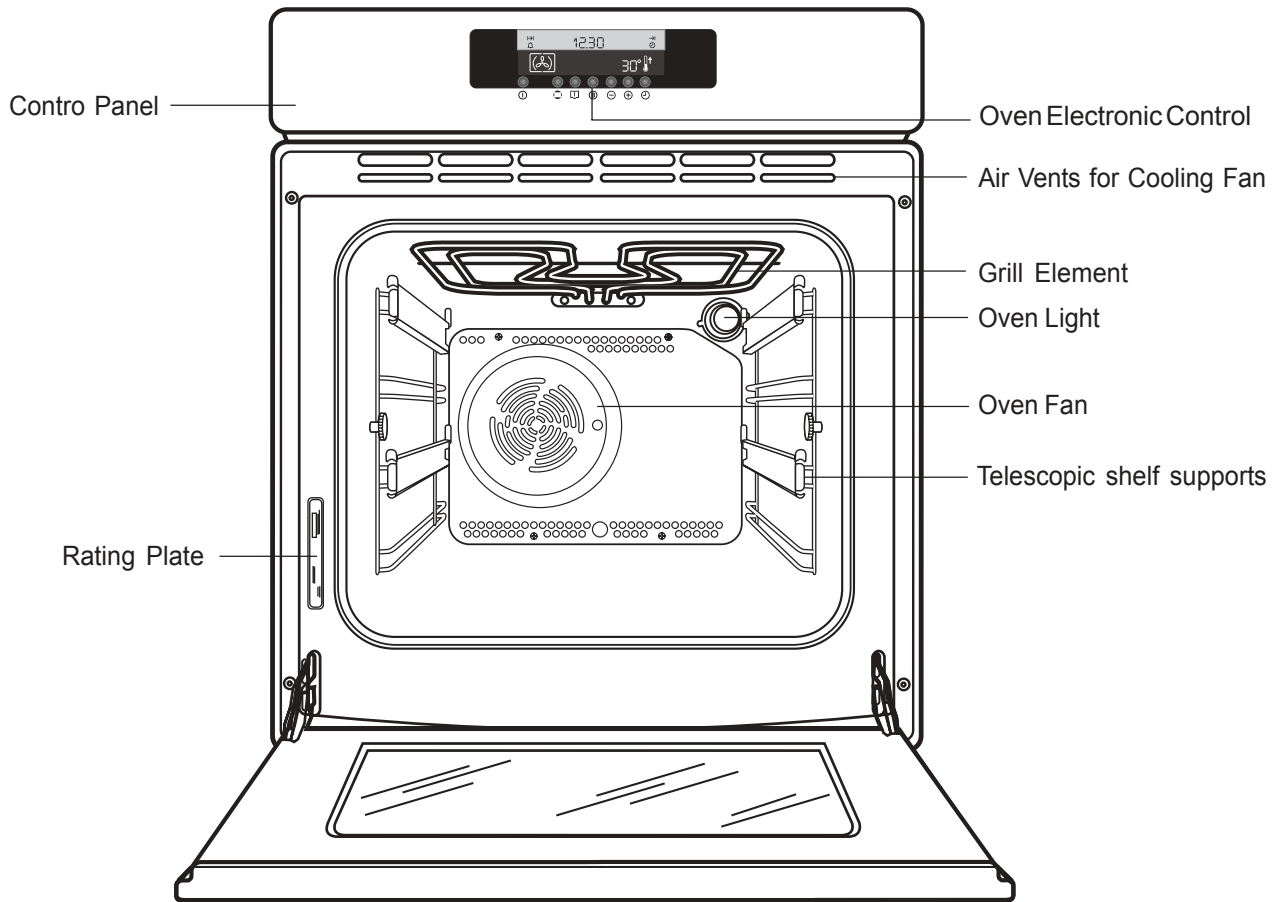

## Oven accessories

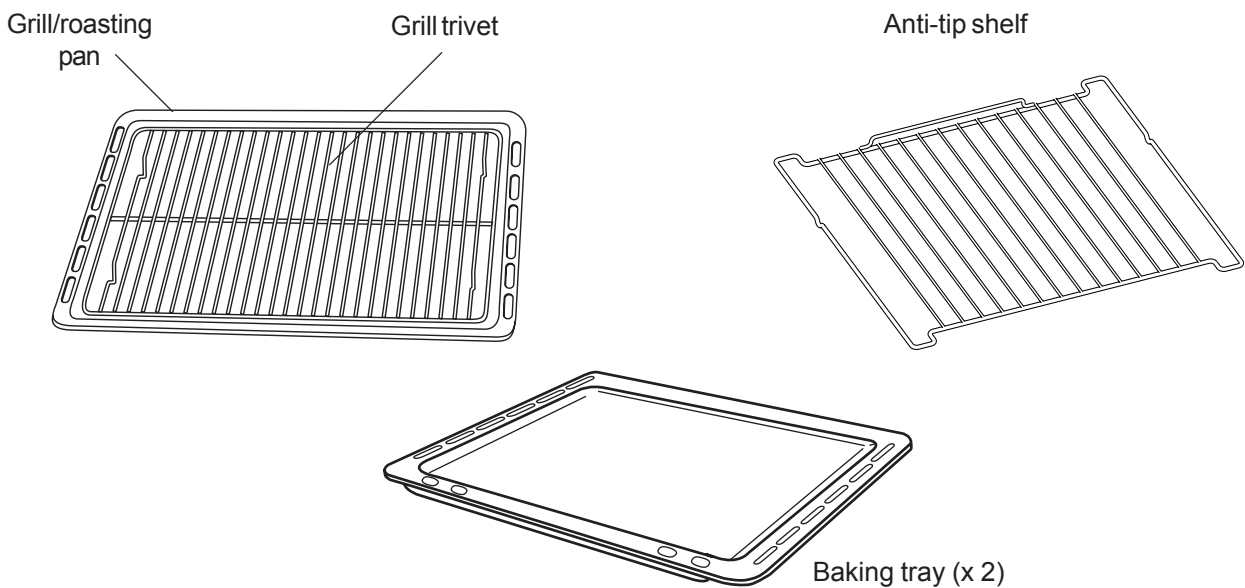

# The Oven Electronic Control

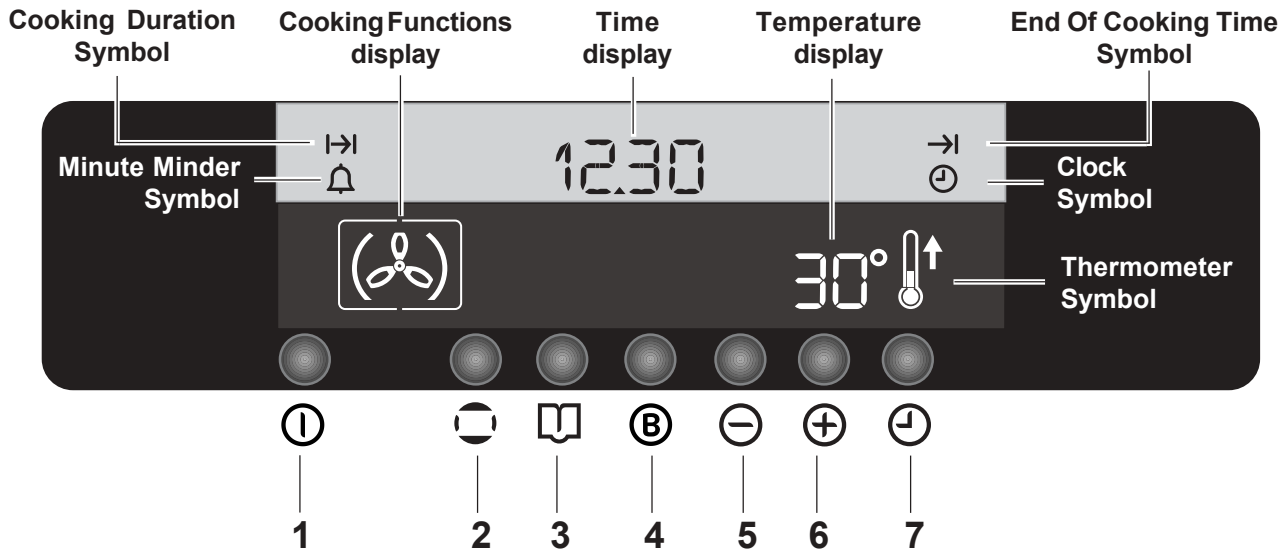

## General Features of The Oven Electronic Control

All the oven functions are controlled by an electronic device. You can select any combination of cooking function, cooking temperature and automatic timing.

## The Oven Electronic Control Display

The display has two sections.

The upper section has a grey background and black symbols and digits. It gives information about the time (the current time of day, the programmed cooking duration, the programmed end of cooking time, etc.), and shows the name of the selected cooking function or recipe.

The lower section has a black background and red symbols and digits. It gives information about the selected cooking function, the selected temperature and the current temperature inside the oven.

## The Oven Electronic Control Buttons

1. ON / OFF Button
2. Cooking Functions Button
3. Recipe Selection Button
4. Fast Heat Up Function Button
5. Decreasing Control Button (Time or Temperature)
6. Increasing Control Button (Time or Temperature)
7. Time Function Button

In the event of a power failure, the programmer will keep all the settings (time of day, programme setting or programme in operation) for about 3 minutes. If power is not restored within 3 minutes, all the settings will be cancelled. When the power is restored, you will have to re-set the programmer.

# The Oven Safety Devices

## The Safety Thermostat

This oven is provided with a safety thermostat. In case of malfunctioning of the main thermostat, and consequential over-heating, the safety device will stop the power supply to the appliance. If this happens, call your local Service Force Centre. Under no circumstances should you attempt to repair the appliance yourself.

## The cooling fan

The cooling fan operates during cooking. Air is expelled through vents between the oven door and the control panel, as shown in the diagram (page 4).

The cooling fan may run on after the oven is switched off to keep the controls cool. This is absolutely normal.

# When the Oven is First Installed

When the oven is first connected to the electrical supply, or when supply is restored after a long power failure, the upper section of the display shows this message:

**"WELCOME TO \* KRONOS-3 \* BASIC -2 \* DANSK \* DEUTSCH \* ENGLISH \* ESPANOL \* FRANCAIS \* ITALIANO \* NEDERLANDS \* NORSK \* PORTUGUES \* SVENSKA"**

This message lists all the languages which can be chosen to operate with the Oven Electronic Control (Fig. 1).

Symbol ► flashing near the "Clock Symbol" ⌚ means that you need to set the current time of day before using the oven.



Fig. 1

## To set the Correct Time of Day

1. Press the "Time Function Button" ⌚. While symbol ► flashes near the "Clock Symbol" ⌚, set the current time of day pressing buttons ◀ or ▶ (Fig. 2). Once you have set the time, the symbol ► keeps flashing for 5 seconds and then disappears. This means that the setting has been stored in the Electronic Control memory.
2. If symbol ► stops flashing before you have had time to set the clock, press the "Time Function Button" ⌚ twice. The symbol ► starts flashing again. Then, proceed as described at point 1.

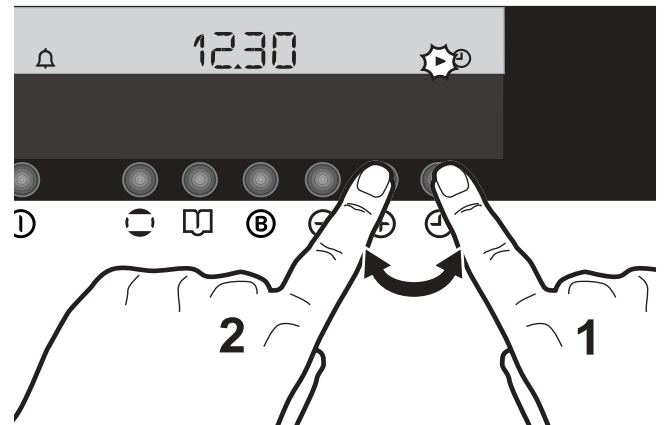



Fig. 2

## To Select the Language

You can choose the language to be used in the Oven Electronic Control display.

The oven must be OFF when carrying out this operation.

1. Press the "Cooking Function Button" ⏸ and the "Recipe Selection Button" 📖 at the same time and keep them pressed for 2 seconds at least. The Electronic Control beeps once and the display shows the current language selection. (Fig. 3).
2. Within 5 seconds, press button ▶ to select your language (Fig. 4).
3. Once you selected your language, you have 5 seconds to confirm your selection by pressing the "Cooking Function Button" ⏸ and the "Recipe Selection Button" 📖 at the same time and keeping them pressed for 2 seconds at least.

 Please note that anytime you carry out a step of this procedure, you have 5 seconds to carry out the following step. If you wait more than 5 seconds the Electronic Control switches off and the selection is not stored in its memory.

Here follows the list of available languages:  
Danish (**DANSK**), German (**DEUTSCH**), English (**ENGLISH**), Spanish (**ESPANOL**), French (**FRANCAIS**), Italian (**ITALIANO**), Dutch (**NEDERLANDS**), Norwegian (**NORSK**), Portuguese (**PORTUGUES**) and Swedish (**SVENSKA**).

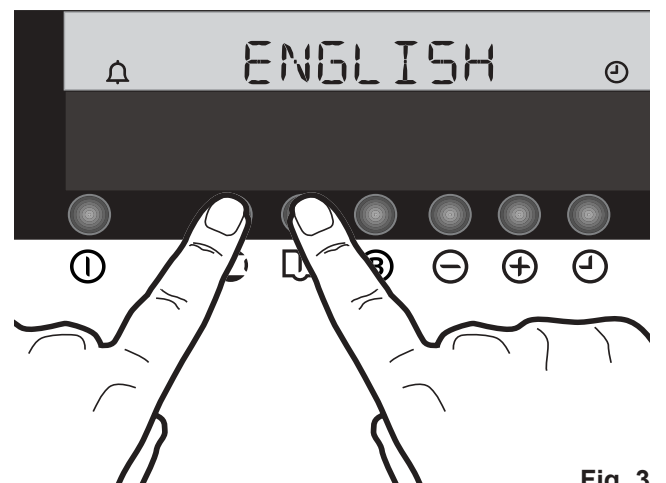

Fig. 3

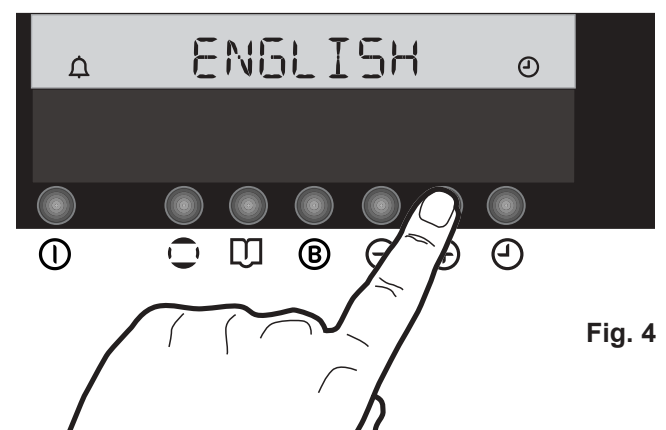



Fig. 4

# Before the First use of the Oven

 Remove all packaging, both inside and outside the oven, before using it.

 The oven will work only if the time of day has been set.

## To switch the oven on and off





The oven must be switched on before setting any cooking function or programme. When button  is pressed, the oven light will switch on. The oven symbol and the message "LIGHT" appear on the display (Fig. 5).



To switch off the oven, you can press button  at any time. Any cooking function or programme will stop, the oven light will switch off and the time display will show the time of day only.

 Before first use, the oven should be heated without food.

During this time, an unpleasant odour may be emitted. This is absolutely **normal**, and is caused by residues of manufacturing.

Ensure the room is well ventilated.

1. Set the time of day with the electronic programmer (see paragraph "To set the correct time of day").
2. Press the "On/Off" button  to switch on the oven.
3. Press the "Cooking Functions" button  twice and select the "Conventional Cooking" function  (Fig. 6).
4. Set the temperature to 250°C using button  (Fig. 7).
5. Allow the oven to run **empty** for approximately 45 minutes.
6. Open a window for ventilation.

This procedure should be repeated with the "Fan Cooking"  function and the "Double Grill"  function for approximately 5-10 minutes.

Once this operation is carried out, let the oven cool down, then clean the oven cavity with a soft cloth soaked in warm water to which a little mild washing-up liquid has been added.

Before cooking for the first time, carefully wash the oven accessories.

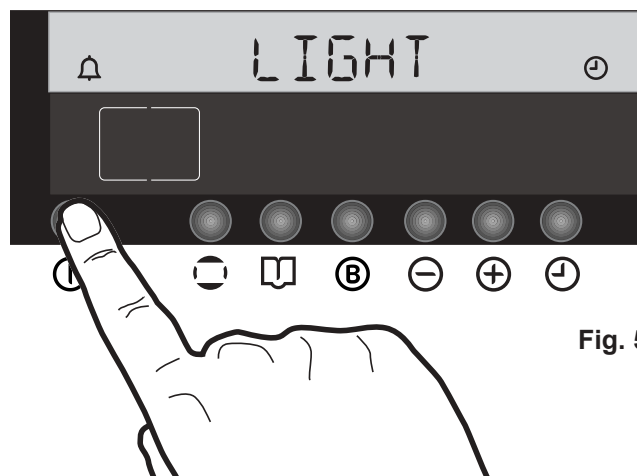

Fig. 5

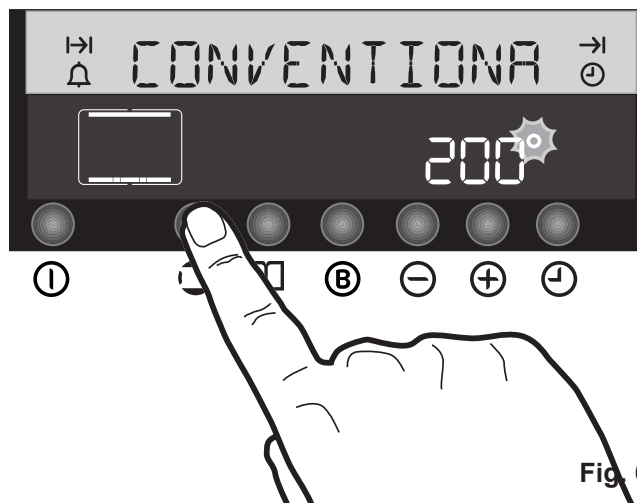

Fig. 6

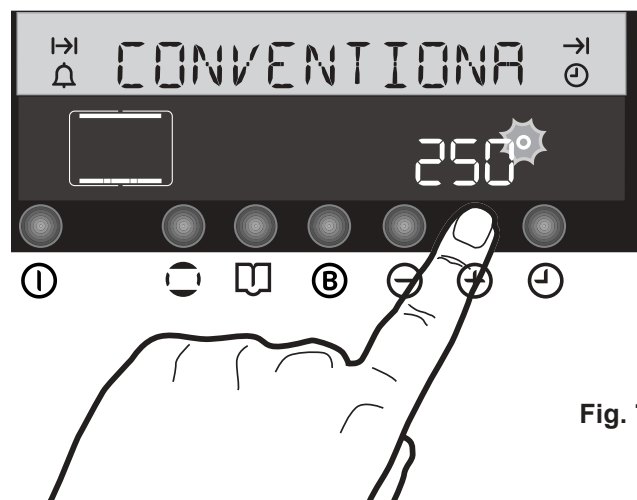











Fig. 7

















## To select a cooking function

1. Switch on the oven by pressing the "On/Off" button .
2. Press the "Cooking Functions" button  to select the required oven function. Each time button  is pressed, a different cooking symbol appears in the lower section of the display and the description of the cooking function appears as a message in the upper section. The pre-set temperature for each function is shown in the lower section, and symbol "●" flashes on the right hand (Fig. 8).
3. Symbol "●" flashing means that it is possible to adjust the pre-set temperature by pressing button  or  (Fig. 9). Temperature level is adjusted in 5 degree steps. Please note that symbol "●" will flash for 5 seconds.
4. When 5 seconds elapse, symbol "●" will disappear showing that the temperature level has been stored in the Electronic Control memory. The thermometer symbol rises slowly  , indicating the degree to which the oven is currently heated.
5. When the required temperature is reached, an acoustic alarm will sound for a short time and the thermometer symbol  will light permanently.

## To set the temperature and time

Buttons  and "+" are used to adjust both the temperature and the time settings. Details about using them according to the different functions of the Oven Electronic Control are given in the following chapters.

As a general rule, please note that:

- > Buttons  and  are used to increase or decrease the temperature settings while symbol "●" flashes on the right hand of the temperature display. When you choose a cooking function, symbol "●" keeps flashing for 5 seconds only. This is the useful interval to press buttons  or  and select your temperature setting. Once these 5 seconds elapse, symbol "●" disappears and the thermometer symbol  comes on: this means that the current selection has been stored in the Oven Electronic Control memory and that the oven is currently heating up.
- > Buttons  and  are used to increase or decrease the time settings while the symbol  is flashing near the "Clock" symbol , the "Minute Minder" symbol , the "Cooking Duration"  symbol or the "End Of Cooking Time" symbol . When you choose a time function, symbol  keeps flashing for 5 seconds only. This is the useful interval to press buttons  or  and select your time setting. Once these 5 seconds elapse, symbol  stops flashing: this means that the current selection has been stored in the Oven Electronic Control memory.

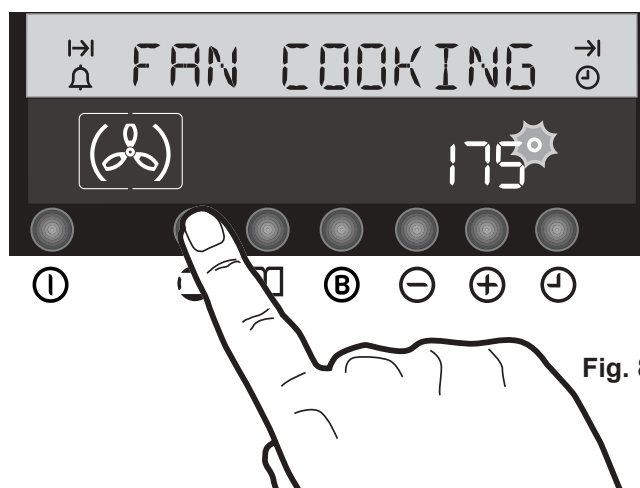

Fig. 8

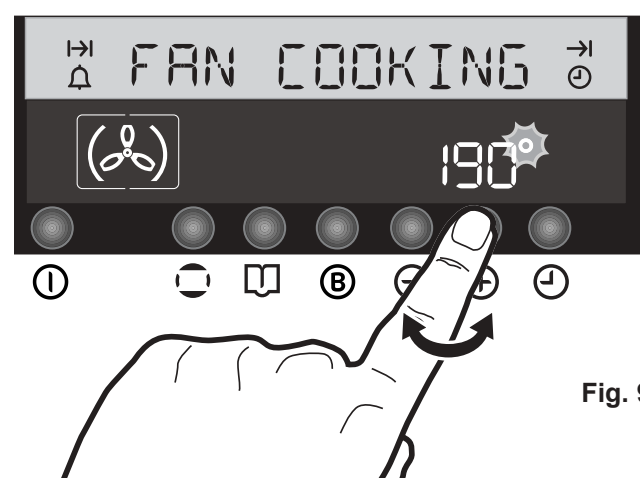











Fig. 9









# Cooking Functions

The following list displays in sequence all the available cooking functions.

- 1  **FAN COOKING** - This setting allows you to roast or roast and bake simultaneously using any shelf, without flavour transference. Pre-set temperature: 175°C.
- 2  **CONVENTIONAL COOKING** - The heat comes from both the top and bottom element, ensuring even heating inside the oven. Pre-set temperature: 200°C.
- 3  **GRILL** - It can be used for grilling small quantities. Pre-set temperature: 250°C.
- 4  **THERMAL GRILLING** - This function offers an alternative method of cooking food items, normally associated with conventional grilling. The grill element and the oven fan operate together, circulating hot air around the food. Pre-set temperature: 180°C.  
**Select a maximum temperature of 200°C.**
- 5  **PIZZA** - The bottom element provides direct heat to the base of pizzas, quiches or pies, while the fan ensures air is circulated to cook the pizza toppings or pie fillings.  
Pre-set temperature: 175°C.
- 6  **DOUBLE GRILL** - The full grill element will be on. Recommended for large quantities. Pre-set temperature: 250°C.
- 7  **BOTTOM** - The heat comes from the bottom of the oven only, to allow you to finish your dishes. Pre-set temperature: 250°C.
- 8  **TOP** - The heat comes from the top of the oven only, to allow to you finish your dishes. Pre-set temperature: 250°C.
- 9  **DEFROST** - The oven fan operates without heat and circulates the air, at room temperature, inside the oven. This function is particularly suitable for defrosting delicate food which could be damaged by heat, e.g. cream filled gateaux, iced cakes, pastries, bread and other yeast products.





# Programming the Oven

## How to set the minute minder





1. Press the "Time Function" button . The symbol  flashes near the "Minute Minder" symbol  and the time display shows "0.00" (Fig. 10).
2. Symbol  will flash for 5 seconds. Within this time, press button  to select the required time (Fig. 11). Maximum time is 23 hours 59 minutes. After another 5 seconds after you have set the time, the symbol  stops flashing. This means that the setting has been stored in the Electronic Control memory and that the countdown started.
3. When the programmed time has elapsed, you hear an acoustic alarm while symbol  flashes and the time display shows "0.00".
4. To switch off the acoustic alarm, press any button.

 **The oven will NOT switch off if in use. The Minute Minder function can also be used when the oven is off.**

### To change the Minute Minder setting

Press the "Time Function" button : the symbol  flashes near the "Minute Minder" symbol . It is now possible to change the Minute Minder setting by pressing button  or  (Fig.11).

### To cancel the Minute Minder:

Press time function button : the symbol  flashes near the "Minute Minder" symbol . Then press button  until the time display shows "0.00".

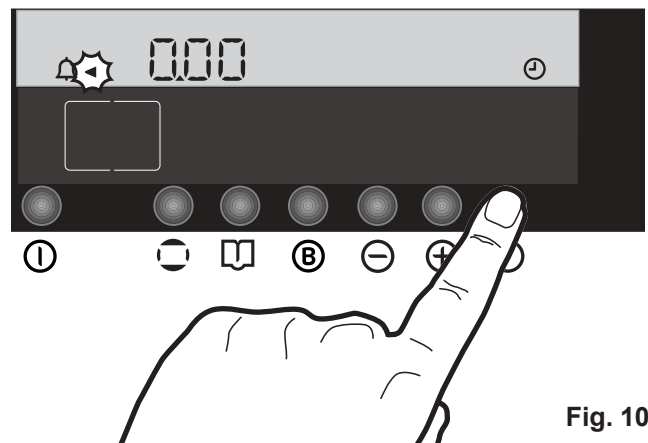

Fig. 10

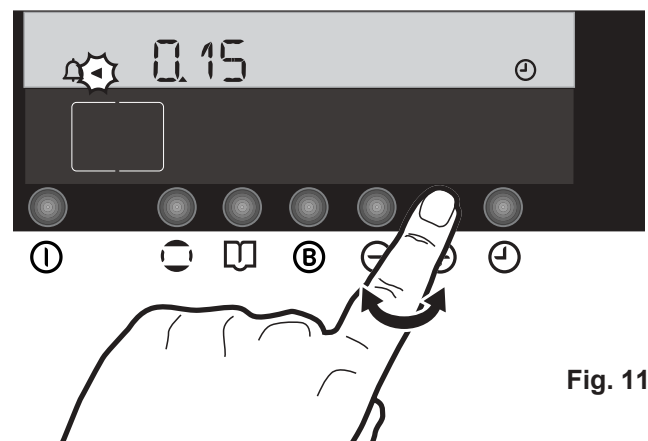













Fig. 11

## To programme the oven to switch off









1. Switch the oven on, place food in the oven, select a cooking function and adjust the cooking temperature, if required.
2. Press the "Time Function" button . The symbol  flashes near the "Cooking Duration" symbol . The time display shows "0.00" at the left hand and the current time of day at the right hand (Fig. 12).
3. Symbol  will flash for 5 seconds. Within this time, press button  to select the required time. Maximum time is 23 hours 59 minutes. Note that the time indication on the right hand will also change as you press button , showing at which time the oven will automatically switch off (fig. 13).
4. After another 5 seconds after you have set the time, the symbol  stops flashing. This means that the setting has been stored in the Electronic Control memory and that the countdown started.
5. When cooking time is over, the oven automatically switches off. You hear an acoustic alarm while symbol  flashes and the time display shows "0.00".
6. To switch off the acoustic alarm, press any button.

### To cancel the Cooking Duration Time:

Press time function button  : the symbol  flashes near the "Cooking Duration" symbol . Then press button  until the time display shows "0.00".

Please note that, if you cancel the "Cooking Duration", the oven does not switch off.

## To programme the Oven to switch on and off

1. Carry out the "Cooking Duration" setting as described at points 1 to 4 in the previous chapter.
2. Press the "Time Function" button  twice: the symbol  flashes near the "End of Cooking Time" symbol  (Fig. 14).
3. Within 5 seconds, press button  to select the required end of cooking time, which is shown at the right hand of the time display (Fig. 15).
4. After another 5 seconds after you have set the time, the symbol  stops flashing, the thermometer symbol  comes off, the temperature display shows "30" and the oven switches off. This means that the setting has been stored in the Electronic Control memory and that the countdown started.
5. The oven will switch on and off automatically according to your settings. When cooking is completed, you hear an acoustic alarm while both symbols  and  flash. The time display shows "0.00" at the left hand.
6. To switch off the acoustic alarm, press any button.

**To cancel the programme, simply cancel the Cooking Duration time as described at the end of the previous chapter.**

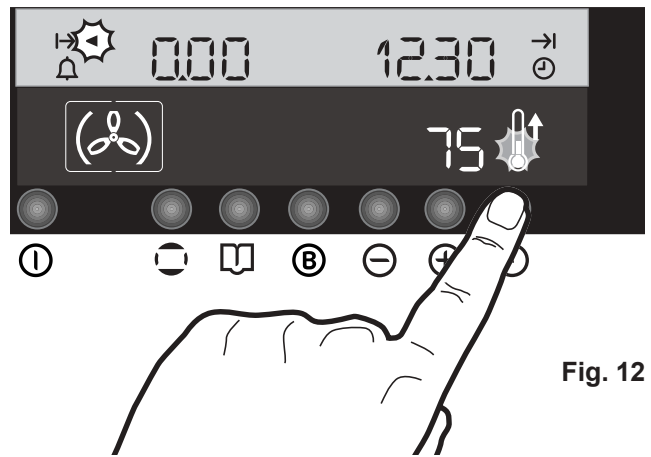

Fig. 12

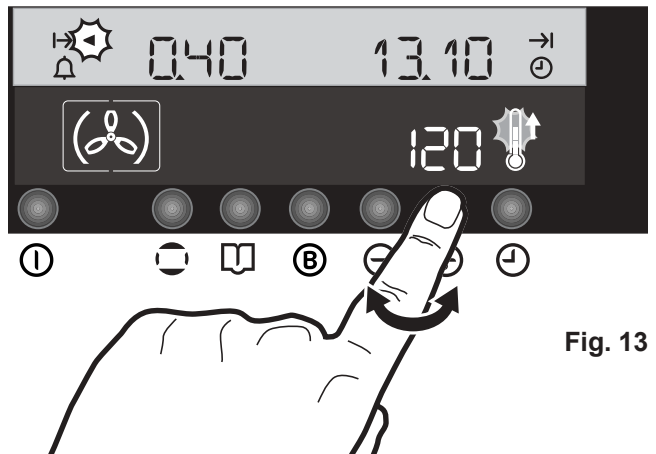

Fig. 13

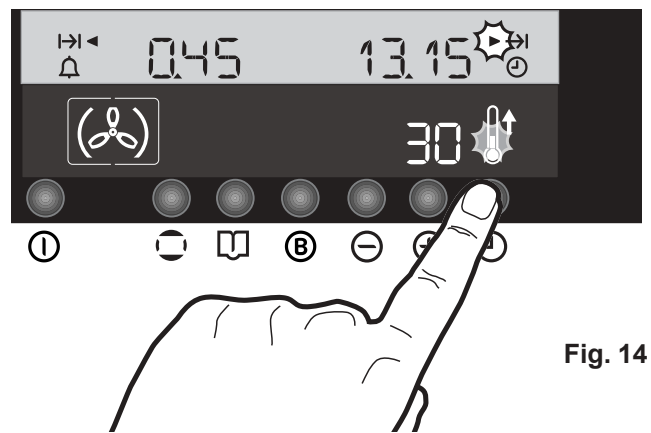

Fig. 14

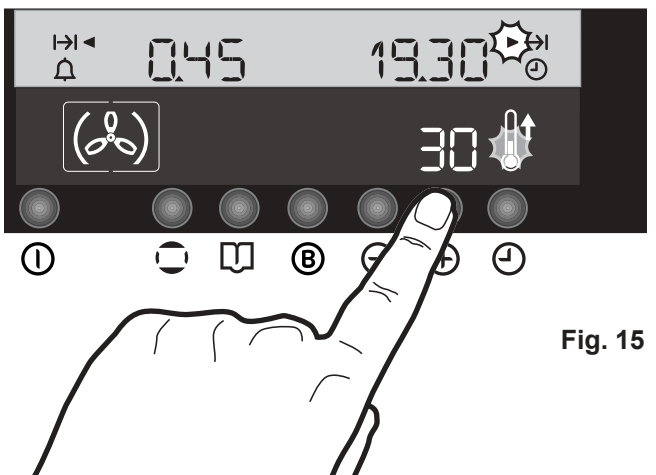

Fig. 15

# Safety and Energy Saving Functions

## Safety Cut-Off Function

The oven will switch off automatically if any change of setting is made, according to the table below (Fig. 16).

If temperature setting is:	the oven will switch off:
250°C	after 1 1/2 hours
from 200 up to 245°C	after 5 1/2 hours
from 120 up to 195°C	after 8 1/2 hours
less than 120°C	after 12 hours

## Child Safety Function

To avoid children switching on the oven, it is possible to lock the oven controls.

1. If the oven is on, switch it off by pressing button ①.
2. Press buttons ② and ③ at the same time and keep them pressed for about 3 seconds. The Electronic Control beeps once and the message 'SAFE' appears in the display (Fig. 17).
3. The oven is now locked. Neither oven functions nor temperatures can be selected.

### To unlock the oven:

Press buttons ② and ③ at the same time and keep them pressed for about 3 seconds. The Electronic Control beeps once and the message 'SAFE' disappears. The oven can now be operated.

## "Fast Heat Up" function (Booster)

After a cooking function has been selected and the temperature has been adjusted, the cavity will gradually heat up until the selected temperature is reached. This will take from 10 to 15 minutes, depending on selected function and temperature.

If it is necessary to reach the required temperature in a shorter time, the fast heat up function can be used.

1. Switch the oven on by pressing the "ON/OFF" button ①.
2. Set the required cooking function and temperature as described in the previous pages.
3. Set the temperature by pressing button ④ or ⑤.
4. Press the "Fast Heat Up Function" button ⑥. The temperature display shows "FHU" (Fig. 18).
5. If you press the "Cooking Function" button ②, the temperature display reverts to the selected temperature and symbol "●" flashes for 5 seconds (Fig. 19). During this interval, you can adjust the temperature setting by pressing button ④ or ⑤.
6. When the required temperature is reached, the Electronic Control beeps for a short time, and the temperature display reverts to the selected temperature.

This function can be used with any cooking function or temperature.

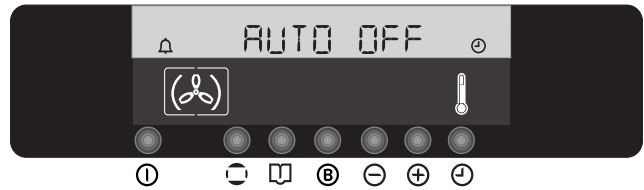

Fig. 16

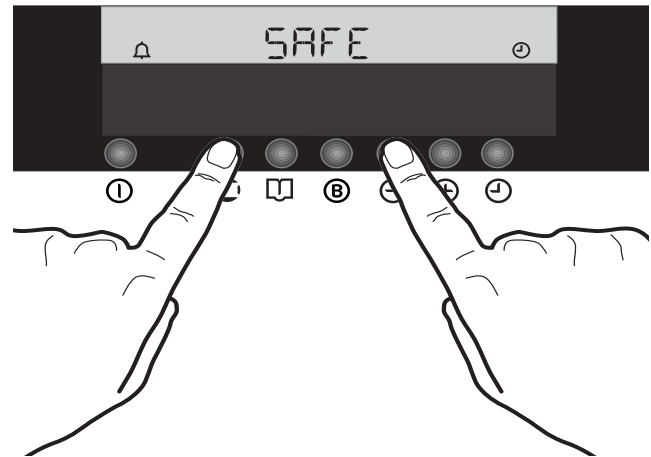

Fig. 17

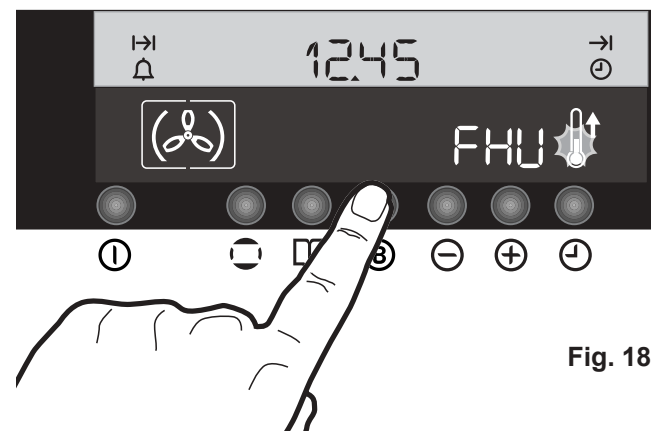

Fig. 18

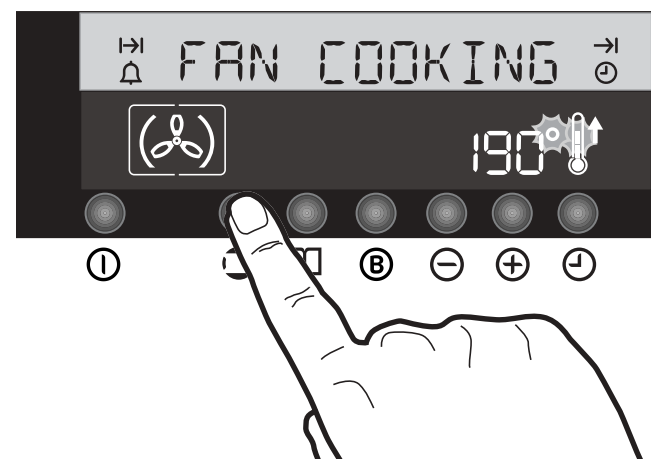

Fig. 19

## Residual Heat Function

When a Cooking Duration time is set, the heating elements of the oven will automatically go off a few minutes before the end of the programmed time, and the oven will use the residual heat to finish your dishes without energy consumption. All current settings will be displayed until the Cooking Duration time is over.

This function will not operate when the Cooking Duration time is less than 15 minutes.

### "Demo" mode

This mode is intended to be used in the shops to demonstrate the oven functionality without any power consumption except the oven lamp. To activate this function the appliance should be off.

1. Press button **(B)** and **(+)** at the same time for approximately 2 seconds (Fig. 20). The Electronic Control beeps once.
2. When you press button **(I)** to switch on the oven, the message "DEMO" appears on the upper section of the display (Fig. 21). You can then select any cooking function, but the oven will not heat up. The thermometer symbol will come on , but it will not flash nor rise.

#### To disable the demo mode:

Press button **(I)** to switch off the oven, then press button **(B)** and **(+)** at the same time for approximately 2 seconds. The Electronic Control beeps once and the oven is ready to operate.

### "Beep" Mode

You can choose to make The Electronic Control beep each time that a button is pressed.

To enable this function, the oven must be off.

1. Press buttons **(I)** and **(+)** at the same time for about 3 seconds. The Electronic Control beeps once (Fig. 22).

#### To disable the "Beep" Function:

1. If the oven is on, press button **(I)** to switch it off.
2. Press buttons **(I)** and **(+)** at the same time for about 3 seconds. The Electronic Control beeps once

## Error code

The Oven Electronic Control does a continuous diagnostic check of the system. If some parameters are not correct, the control unit will stop the activated functions and the corresponding error code will be displayed.

For further details, refer to chapter "Something not working".

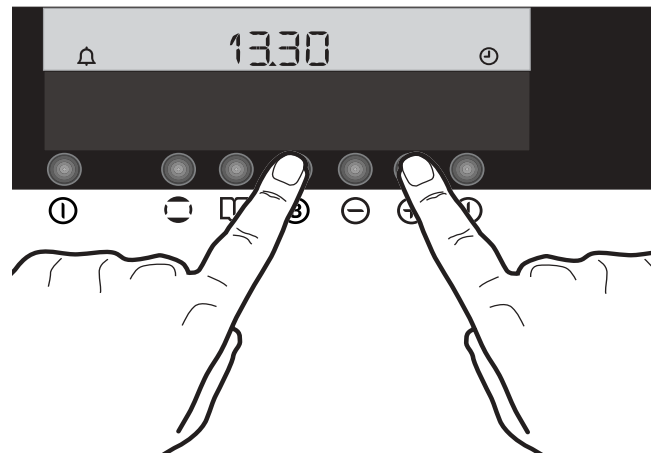

Fig. 20

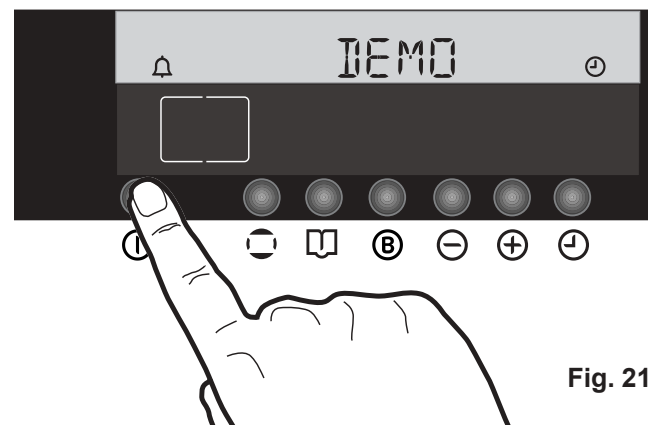

Fig. 21

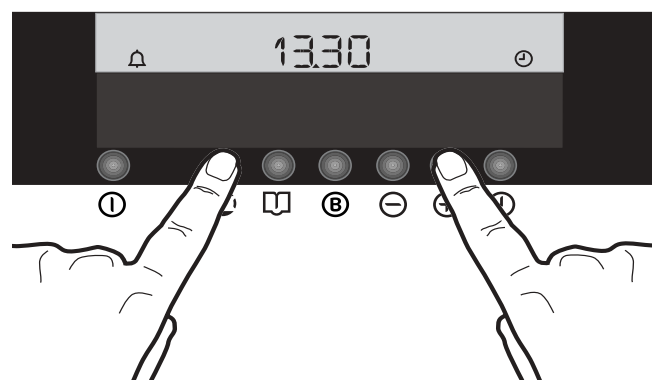













Fig. 22



# The "Recipe Selection" Function

Some recipes have been stored into the Oven Electronic Control memory to allow you to cook ten different dishes using pre-set cooking functions, temperatures and cooking times.

The available recipes are listed at the bottom of this page.

To choose a recipe:

1. Press button  to switch on the oven;
2. Press the "Recipe Selection Function" button  : the upper section of the display will show the name of the recipe, and symbol  will come on near the "Cooking Duration" symbol . This means that a cooking duration is already set in the memory. The lower section will show the symbol of the pre-set cooking function and the pre-set cooking temperature. Symbol  will flash at the right hand of the temperature display. (Fig. 23);
3. When 5 seconds elapse, symbol  disappears showing that the temperature level has been stored in the Electronic Control memory. The thermometer symbol rises slowly , indicating the degree to which the oven is currently heated. The upper section of the display will now show the cooking duration at the left hand and the end of cooking time at the right hand (Fig. 24).
5. If you want, you can adjust both the cooking duration and the end of cooking time by pressing time function button  to select the cooking duration or end of cooking time and, then, using button  or  to adjust the time. Then, follow the instructions given in the previous pages.
6. When cooking time is over, the oven automatically switches off. You hear an acoustic alarm while symbol  flashes and the time display shows "0.00".
6. To switch off the acoustic alarm, press any button.

 You can interrupt the execution of the recipe at any time by pressing button .

 You cannot use the "Fast Heat Up" function once you selected a recipe with the "Recipe Selection" function.

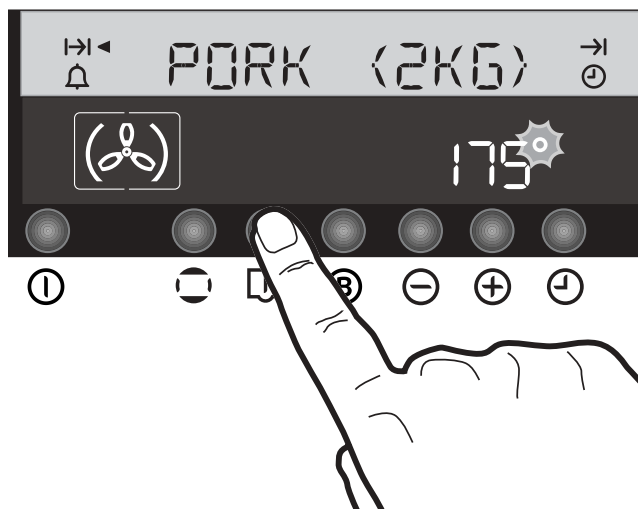

Fig. 23

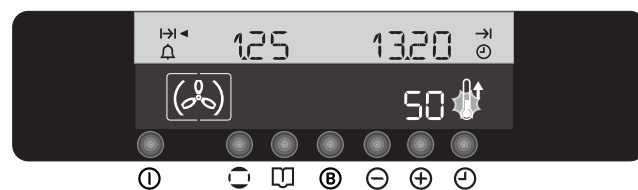

Fig. 24

Dish	Cooking Function	Pre-set temperature	Pre-set cooking time
Pork (2 kg)	Fan cooking	175°C	1 hour 25 minutes
Roastbeef (1 kg)	Fan cooking	200°C	50 minutes
Lamb	Fan cooking	175°C	1 hour 45 minutes
Duck	Fan cooking	160°C	2 hours
Turkey	Fan cooking	160°C	3 hours 5 minutes
Quiches	Conventional cooking	190°C	50 minutes
Potato Gratin	Conventional cooking	180°C	55 minutes
Pizza	Pizza	190°C	25 minutes
Apple Pie	Fan cooking	175°C	40 minutes
Sponge Cake	Fan cooking	160°C	40 minutes

# Using the Oven



**Always cook with the oven door closed.**

*Stand clear when opening the drop down oven door. **Do not** allow it to fall open - support the door using the door handle, until it is fully open.*



The oven has four shelf levels, and is supplied with one shelf. The shelf positions are counted from the bottom of the oven as shown in the diagram.

It is important that these shelves are correctly positioned as shown in the diagram.

**Do not place cookware directly on the oven base.**



**Attention!** - Do not place objects on the oven base and do not cover any part of the oven with aluminium foil while cooking, as this could cause a heat build-up which would affect the baking results and damage the oven enamel. Always place pans, heat-resisting pans and aluminium trays on the shelf which has been inserted in the shelf runners.

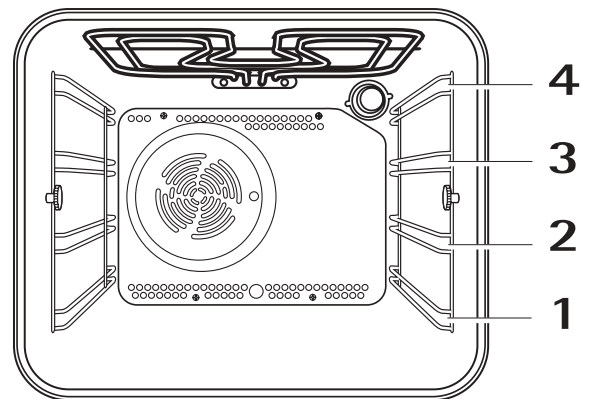

# **i** Hints and Tips

## **Condensation and Steam**

The oven is supplied with an exclusive system which produces a natural circulation of air and the constant recycling of steam. This system makes it possible to cook in a steamy environment and keep the dishes soft inside and crusty outside. Moreover, the cooking time and energy consumption are reduced to a minimum. During cooking steam may be produced which can be released when opening the oven door. This is absolutely normal.

 **However, always stand back from the oven when opening the oven door during cooking or at the end of it to allow any build up of steam or heat to release.**

 **When food is heated, it produces steam in the same way as a boiling kettle does. When steam comes in contact of the oven door glass, it will condense and produce water droplets. To reduce condensation, ensure the oven is well heated before placing food in the oven cavity.**

**A short oven pre-heating (about 10 minutes) will then be necessary before anycooking. We recommend you to wipe away condensation after each use of the appliance.**

 **To open the oven door, always catch the handle in its central part.**

## **Cookware**

- Use any oven proof cookware which will withstand temperatures of 250°C.
- Baking trays, oven dishes, etc. should not be placed directly against the grid covering the fan at the back of the oven, or placed on the oven base.
- Do not use baking trays larger than 30 cm x 35 cm (12 in x 14 in) as they will restrict the circulation of heat and may affect performance.

## **The effects of dishes on cooking results**

Dishes and tins vary in their thickness, conductivity, colour, etc. which affects the way they transmit heat to the food inside them.

- A** Aluminium, earthenware, oven glassware and bright shiny utensils reduce cooking and base browning.
- B** Enamelled cast iron, anodized aluminium, aluminium with non-stick interior and coloured exterior and dark, heavy utensils increase cooking and base browning.

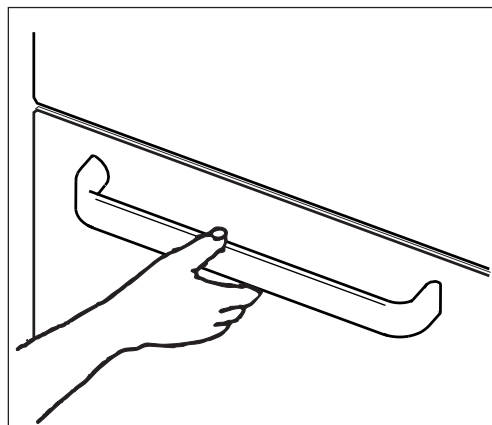

# The Conventional Oven

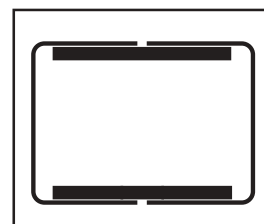

When using this setting, heat comes from both the top and bottom elements. This allows you to cook on a single level and is particularly suitable for dishes which require extra base browning such as quiches and flans.

Gratins, lasagnes and hotpots which require extra top browning also cook well in the conventional oven. This form of cooking gives you the opportunity to cook without the fan in operation.



CONVENTIONAL OVEN FUNCTION SYMBOL  
PRE-SET TEMPERATURE: 200°C

## How to use the conventional oven

1. Switch the oven ON.
2. Select the Conventional Oven Function by pressing the Cooking Functions Control button  until the symbol  appears in the display.

## Bottom oven element only

This function is particularly useful when blind-baking pastry. It may also be used to finish off quiches or flans to ensure the base pastry is cooked through.

**Pre-set temperature is 250°C.**

## Top oven element only

This function is particularly useful to finish off quiches or flans to ensure the top pastry is cooked through.

**Pre-set temperature is 250°C.**

## THINGS TO NOTE

During cooking, the cooling fan will operate in the same way as described for the fan oven function.

## Hints and Tips

The middle shelf position allows for the best heat distribution. To increase base browning simply lower the shelf position. To increase top browning, raise the shelf position.

The material and finish of the baking trays and dishes used will affect base browning. Enamelware, dark, heavy or non-stick utensils increase base browning, while oven glassware, shiny aluminium or polished steel trays reflect the heat away and give less base browning.

Always place dishes centrally on the shelf to ensure even browning.

Stand dishes on suitably sized baking trays to prevent spillage onto the base of the oven and make cleaning easier.

**Do not** place dishes, tins or baking trays directly on the oven base as it becomes very hot and damage will occur.

For faster preheating use the Fast Heat-Up Function.

Single level cooking gives best results. If you require more than one level cooking use the fan cooking function.

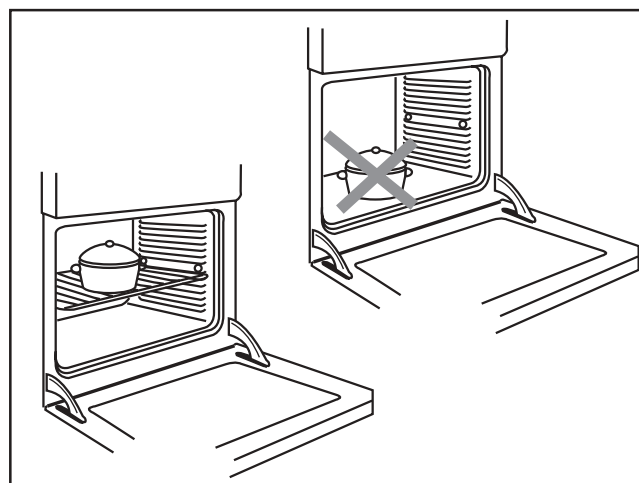



# The Fan Oven

The air inside the oven is heated by the element around the fan situated behind the back panel. The fan circulates hot air to maintain an even temperature inside the oven.

**The advantages of cooking with this function are:**

- **Faster Preheating**

As the fan oven quickly reaches temperature, it is not usually necessary to preheat the oven although you may find that you need to allow an extra 5-7 minutes on cooking times. For recipes which require higher temperatures, best results are achieved if the oven is preheated first, e.g. bread, pastries, scones, souffles, etc.

- **Lower Temperatures**





Fan oven cooking generally requires lower temperatures than conventional cooking.

Follow the temperatures recommended in the cooking chart. Remember to reduce temperatures by about 20-25 °C for your own recipes which use conventional cooking.

- **Even Heating for Baking**

The fan oven has uniform heating on all shelf positions. This means that batches of the same food can be cooked in the oven at the same time. However, the top shelf may brown slightly quicker than the lower one.

This is quite usual. There is no mixing of flavours between dishes.

-  1. Switch the oven on.  
2. Press the Cooking Functions Control button  and select the "Fan Cooking" function .
3. If necessary adjust temperature setting using the  or  buttons.

## THINGS TO NOTE

- The oven light will come on when the oven is switched on.
- The cooling fan will operate continually during cooking. It may run on after the oven is switched off to keep the controls cool. This is quite normal.

## NOTE

The action of the cooling fan will depend on how long the oven has been used and at what temperature. It may not switch on at all at lower temperature settings nor run on where the oven has only been used for a short time.

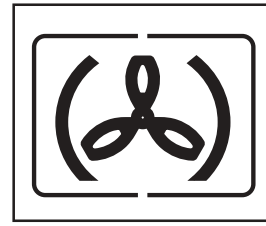

**FAN OVEN FUNCTION SYMBOL**  
**PRE-SET TEMPERATURE: 175°C**

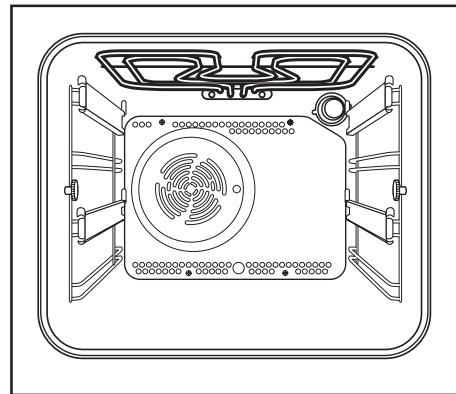

## Hints and Tips

Shelf positions are not critical, but make sure the shelves are evenly spaced.

When cooking more than one dish in the fan oven, place dishes centrally on the shelves rather than several dishes on one shelf.

When the oven is full, you may need to allow a slightly longer cooking time.

A shelf may be placed on the floor of the oven. Place dishes on a shelf in this position rather than on the oven base, to allow air circulation around the food.

When the oven is full of the same food, e.g. equal trays of small cakes or equal size victoria sandwich cakes, then they will be cooked in the same time and removed from the oven together. When different sizes of trays or types of food, e.g. biscuits and cakes are cooked, they will not necessarily be ready together.





The fan oven can be used to heat foods through without thawing first, e.g. fruit tarts, mince pies, sausage rolls, and other small pastry items. Use a temperature of 190-200°C and allow 20-40 minutes (depending on the quantity of food in the oven).

The use of too high temperatures can cause uneven browning. Check with the recommendations for oven temperatures given in the cooking charts, but be prepared to adjust the temperature by 10°C if necessary. Remember to reduce temperatures by about 20-25°C for your own conventional recipes.

The meat tin **should not** be placed on a heated hotplate or burner as this may cause the enamel to crack.

# Cooking Chart- Conventional and Fan Oven

**i** Cooking times in the tables do not include pre-heating. We recommend to pre-heat the oven for about 10 minutes before cooking.

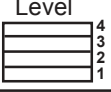
Weight (gr.)	TYPE OF DISH	Traditional Cooking 		Fan Cooking 		Cooking time  minutes	NOTES
		Level 	temp. °C	Level 	temp. °C		
	<b>CAKES</b>						
	Whisked recipies	2	170	2 (1 and 3)*	160	45 ~ 60	In cake mould
	Shortbread dough	2	170	2 (1 and 3)*	160	20 ~ 30	In cake mould
	Butter-milk cheese cake	1	160	2	150	60 ~ 80	In cake mould
	Apple cake	1	180	2 (1 and 3)*	170	40 ~ 60	In cake mould
	Strudel	2	175	2	150	60 ~ 80	
	Jam-tart	2	175	2 (1 and 3)*	160	30 ~ 40	
	Fruit cake	1	175	1	160	45 ~ 60	In bread tin
	Sponge cake	1	175	2 (1 and 3)*	160	30 ~ 40	In cake mould
	Christmas cake	1	170	1	160	40 ~ 60	In cake mould
	Plum cake	1	170	1	160	50 ~ 60	In bread tin
	Small cakes	2	175	2 (1 and 3)*	160	25 ~ 35	In baking tray
	Biscuits	2	160	2 (1 and 3)*	150	20 ~ 30	In baking tray
	Meringues	2	100	2 (1 and 3)*	100	90 ~ 120	In baking tray
	Buns	2	190	2 (1 and 3)*	180	12 ~ 20	In baking tray
	Pastry: Choux	2	200	2 (1 and 3)*	190	15 ~ 25	In baking tray
	<b>BREAD AND PIZZA</b>						
1000	White bread	1	190	2	180	40 ~ 60	1-2 pieces
500	Rye bread	1	190	1	180	30 ~ 45	In bread tin
500	Bread rolls	2	200	2 (1 and 3)*	175	20 ~ 35	6-8 rolls
250	Pizza	1	210	2 (1 and 3)*	190	15 ~ 30	on baking tray
	<b>FLANS</b>						
	Pasta flan	2	200	2 (1 and 3)*	175	40 ~ 50	in mould
	Vegetable flan	2	200	2 (1 and 3)*	175	45 ~ 60	in mould
	Quiches	1	200	2 (1 and 3)*	180	35 ~ 45	in mould
	Lasagne	2	180	2	160	45 ~ 60	in mould
	Cannelloni	2	200	2	175	40 ~ 55	in mould
	<b>MEAT</b>						
1000	Beef	2	190	2	175	50 ~ 70	On grid
1200	Pork	2	180	2	175	100 ~ 130	On grid
1000	Veal	2	190	2	175	90 ~ 120	On grid
1500	English roast beef						
1500	rare	2	210	2	200	50 ~ 60	On grid
1500	medium	2	210	2	200	60 ~ 70	On grid
1500	well done	2	210	2	200	70 ~ 80	On grid
2000	Shoulder of pork	2	180	2	170	120 ~ 150	With rind
1200	Shin of pork	2	180	2	160	100 ~ 120	2 pieces
1200	Lamb	2	190	2	175	110 ~ 130	Leg
1000	Chicken	2	190	2	175	60 ~ 80	Whole
4000	Turkey	2	180	2	160	210 ~ 240	Whole
1500	Duck	2	175	2	160	120 ~ 150	Whole
3000	Goose	2	175	2	160	150 ~ 200	Whole
1200	Rabbit	2	190	2	175	60 ~ 80	Cut in pieces
1500	Hare	2	190	2	175	150 ~ 200	Cut in pieces
800	Pheasant	2	190	2	175	90 ~ 120	Whole
	Meat loaf	2	180	2	160	40 ~ 60	in bread pan
	<b>FISH</b>						
1200	Trout/Sea bream	2	190	2 (1 and 3)*	175	30 ~ 40	3-4 fishes
1500	Tuna fish/Salmon	2	190	2 (1 and 3)*	175	25 ~ 35	4-6 fillets

This chart is intended as a guide only. It may be necessary to increase or decrease the temperature to suit your individual requirements. Only experience will enable you to determine the correct setting for your personal requirements.

If you wish to cook more than one dish at the same time, we suggest that you change the cooking levels of your dishes during the last 5-10 minutes in order to obtain a more uniform colour of your dishes.

(\*) If you need to cook more than one dish at the same time, we recommend you to place them on the levels quoted between brackets. Shelf positions are counted from bottom of the oven.

# Grilling







**Grilling must be carried out with the oven door closed.**

**The grill pan handles must be removed from the pan during grilling.** Always use oven gloves to remove and replace the grill pan handles.

Ensure that you **support** the grill pan when removing it from the oven.

## How to Use the Double Grill





1. Switch the oven on.
2. Select the Double Grill function by pressing the Cooking Functions Control button  until the symbol  appears in the display.
3. If necessary adjust temperature setting using the  or  buttons.
4. Adjust the grid and grill pan runner position to allow for different thicknesses of food. Position the food close to the element for faster cooking and further away for more gentle cooking.

Preheat the grill on a full setting for a few minutes before sealing steaks or toasting. Adjust the heat setting and the shelf as necessary, during cooking.

During cooking, the cooling fan and the thermostat control light will operate in the same way as described for the fan oven function.

## How to Use the Grill Element

The inner grill provides quick direct heat to the central area of the grill pan. Use the inner grill element for cooking small quantities, it can help to save energy.

1. Switch the oven ON.
2. Select the Grill Element by pressing the Cooking Functions Control button  until the symbol  appears on the display.
3. If necessary adjust temperature setting using the  or  buttons.
4. Adjust the grid and grill pan runner position to allow for different thicknesses of food and follow the instructions for grilling.

## Hints and Tips

- Most foods should be placed on the grid in the grill pan to allow maximum circulation of air to lift the food out of the fats and juices. Food such as fish, liver and kidneys may be placed directly on the grill pan, if preferred.
- Food should be thoroughly dried before grilling to minimise splashing. Brush lean meats and fish lightly with a little oil or melted butter to keep them moist during cooking.
- Accompaniments such as tomatoes and mushrooms may be placed underneath the grid when grilling meats. When toasting bread, we suggest that the top runner position is used. The food should be turned over during cooking, as required.

**The grill element is controlled by the thermostat. During cooking, the grill cycles on and off to prevent overheating.**

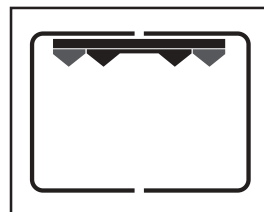

**DOUBLE GRILL FUNCTION SYMBOL  
PRE-SET TEMPERATURE: 250°C**

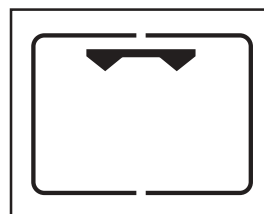



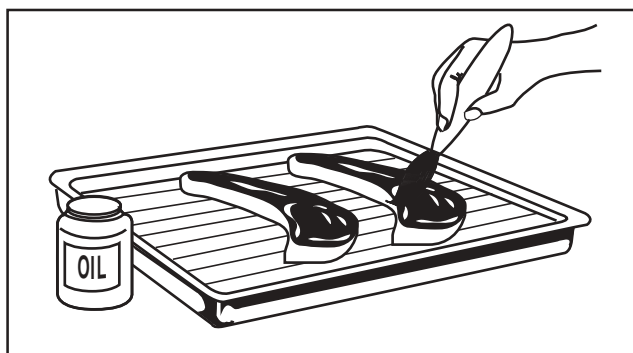

**GRILL ELEMENT SYMBOL  
PRE-SET TEMPERATURE: 250°C**



## How to Use the Thermal Grill

Thermal grilling offers an alternative method of cooking food items normally associated with conventional grilling. The grill element and the oven fan operate alternately, circulating hot air around the food. The need to check and turn the food is reduced. Thermal grilling helps to minimise cooking smells in the kitchen.

With the exception of toast and rare steaks, you can thermally grill all the foods you would normally cook under a conventional grill. Cooking is more gentle, therefore food generally takes a little longer to cook with thermal grilling compared with conventional grilling. One of the advantages is that larger quantities can be cooked at the same time.

1. Switch the oven on.
2. Select the Thermal Grilling Oven Function by pressing the Cooking Functions Control button  until the symbol  appears on the display.
3. If necessary, press  or  buttons to adjust the temperature setting.
4. Adjust the grid and grill pan runner position to allow for different thicknesses of food and follow the instructions for grilling.

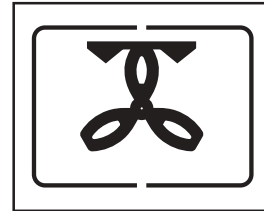

**THERMAL GRILLING**  
**PRE-SET TEMPERATURE: 180°C**  
**DO NOT EXCEED 200°C**

## Hints and Tips



Prepare foods in the same way as for conventional grilling. Brush lean meats and fish lightly with a little oil or butter to keep them moist during cooking.

## Cooking Chart - Grilling

 Cooking times in the tables do not include pre-heating. We recommend to pre-heat the oven for about 10 minutes before cooking.

A general guide to cooking times is given below but these times may vary slightly depending on the thickness and quantity of food being cooked.

### Grilling -

TYPE OF DISH	Quantity		Grilling		Cooking time (minutes) 	
	Pieces	Weight	Level 	temp. °C	Upper side	Lower side
Fillet steaks	4	800	3	250	12 ~ 15	12 ~ 14
Beef-steaks	4	600	3	250	10 ~ 12	6 ~ 8
Sausages	8	—	3	250	12 ~ 15	10 ~ 12
Pork chops	4	600	3	250	12 ~ 16	12 ~ 14
Chicken (cut in two)	2	1000	3	250	30 ~ 35	25 ~ 30
Kebabs	4	—	3	250	10 ~ 15	10 ~ 12
Chicken (breast)	4	400	3	250	12 ~ 15	12 ~ 14
Hamburger	6	600	3	250	10 ~ 15	8 ~ 10
Fish (fillets)	4	400	3	250	12 ~ 14	10 ~ 12
Sandwiches	4-6	—	3	250	5 ~ 7	—
Toast	4-6	—	3	250	2 ~ 4	2 ~ 3

### Thermal grilling (Select a maximum temperature of 200°C)





TYPE OF DISH	Quantity (gr.)	Shelf level	Temp. °C	Time in minutes	
				lower side	upper side
Rolled joints (turkey)	1000	3	200	30 ~ 40	20 ~ 30
Chicken (cut in two)	1000	3	200	25 ~ 30	20 ~ 30
Chicken legs	—	3	200	15 ~ 20	15 ~ 18
Quail	500	3	200	25 ~ 30	20 ~ 25
Vegetable gratin	—	3	200	20 ~ 25	—
St. Jacques shells	—	3	200	15 ~ 20	—
Mackerel	—	3	200	15 ~ 20	10 ~ 15
Fish slices	800	3	200	12 ~ 15	8 ~ 10

(\*) Food should be turned during cooking using these times as a guide.

The times quoted above are given as a guide and should be adjusted to suit personal taste.

# Pizza oven

The bottom element provides direct heat to the base of pizzas, quiches or pies, while the fan ensures air is circulated to cook the pizza toppings or pie fillings. To obtain the best results use the lower shelf levels.

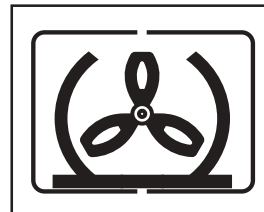

1. Switch the oven ON.
2. Select the Pizza Function by pressing the Cooking Functions Control button  until the symbol  appears on the display.
3. If necessary, press  or  buttons to adjust the temperature setting.



**PIZZA OVEN FUNCTION SYMBOL  
PRE-SET TEMPERATURE: 175°C**

## Pizza

 Cooking times in the tables do not include pre-heating. We recommend to pre-heat the oven for about 10 minutes before cooking.

Weight (gr.)	TYPE OF DISH	Pizza function		Cooking time  minutes	NOTES
		Level 	temp. °C		
700	Pizza, large	1	200	15 ~ 25	on baking tray
500	Pizza, small	1	200	10 ~ 20	on baking tray or on grid
500	Bread rolls	1	200	15 ~ 25	on baking tray

The times quoted above are given as a guide and should be adjusted to suit personal taste.

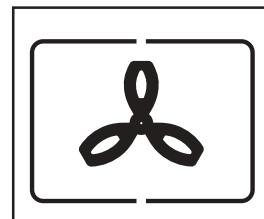

# Defrosting

The oven fan operates without heat and circulates the air, at room temperature, inside the oven. This increases the speed of defrosting. However, please note that the temperature of the kitchen will influence the speed of defrosting. This function is particularly suitable for defrosting delicate food which could be damaged by heat, e.g. cream filled gateaux, iced cakes, pastries, bread and other yeast products.



**DEFROSTING FUNCTION SYMBOL  
TEMPERATURE SETTING CANNOT BE  
CHANGED**

## How to Use Defrosting

- 1) Switch the oven ON.
- 2) Select the Defrosting Oven Function by pressing the Cooking Functions Control button  until the symbol  appears in the display.
- 3) The display will show the indication "def".

## Hints and Tips

- Cover food with a lid, aluminium foil or plastic film to prevent drying out during defrosting.
- ALWAYS COOK THOROUGHLY IMMEDIATELY AFTER THAWING.
- Frozen food should be placed in a single layer when ever possible and turned over half way through the defrosting process.
- Only joints of meat and poultry up to 2 kg. (4 lb.) are suitable for defrosting in this way.

# Cleaning the Oven



*Before cleaning always allow the cooling fan to cool the oven down before switching off at the electricity supply.*

*This appliance cannot be cleaned with steam or with a steam cleaning machine.*

*The oven should be kept clean at all times. A build-up of fats or other foodstuffs could result in a fire, especially in the grill pan.*

## Cleaning materials

Before using any cleaning materials on your oven, check that they are suitable and that their use is recommended by the manufacturer. Cleaners that contain bleach should NOT be used as they may dull the surface finishes. Harsh abrasives should also be avoided.

## External cleaning

Regularly wipe over the control panel, oven door and door seal using a soft cloth well wrung out in warm water to which a little washing-up liquid has been added.



*To prevent damaging or weakening the door glass panels avoid the use of the following:*

- *Household detergent and bleaches*
- *Impregnated pads unsuitable for non-stick saucepans*
- *Brillo/Ajax pads or steel wool pads*
- *Chemical oven pads or aerosols*
- *Rust removers*
- *Bath/Sink stain removers*

Clean the outer and inner door glass using warm soapy water. Should the inner door glass become heavily soiled it is recommended that a cleaning product such as Hob Brite is used. Do not use paint scrapers to remove soilage.



***DO NOT clean the oven door while the glass panels are warm. If this precaution is not observed the glass panel may shatter.***

***If the door glass panel becomes chipped or has deep scratches, the glass will be weakened and must be replaced to prevent the possibility of the panel shattering. Contact your local Service Force Centre who will be pleased to advise further.***

# Cleaning The Oven Door

The oven door is made up of three glasses.  
It is possible to remove them for easier cleaning.



Warning - The oven door may bang shut if you try to extract the inner glasses when the oven door is still fitted to the oven.

Before cleaning the oven door, we recommend you to remove it from the oven.

Proceed as follows:

1. open the oven door completely and locate the two hinges which link the door to the oven;

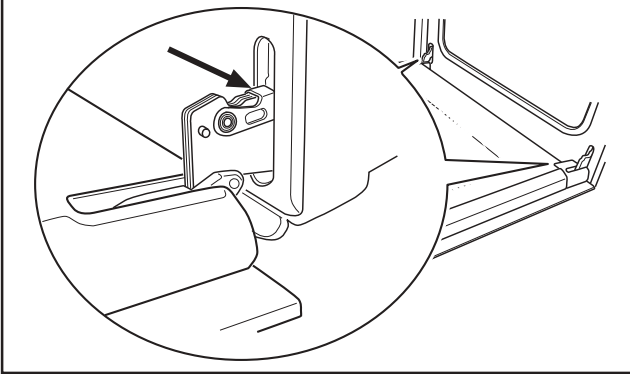

2. unlock and turn the small levers located on the two hinges;

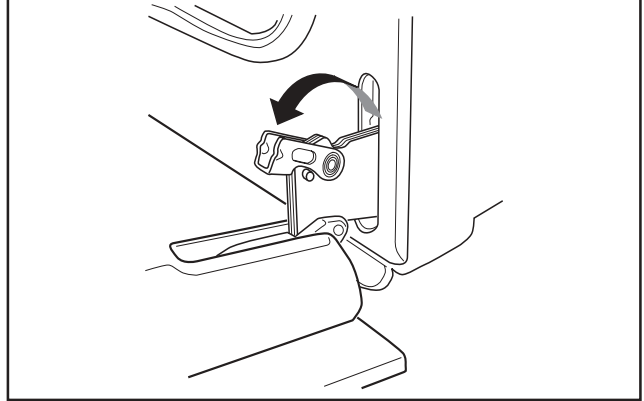

3. handle the door by its left- and right-hand sides, then slowly turn it towards the oven until it is half-closed; at this point, gently pull the oven door away from the oven frame;

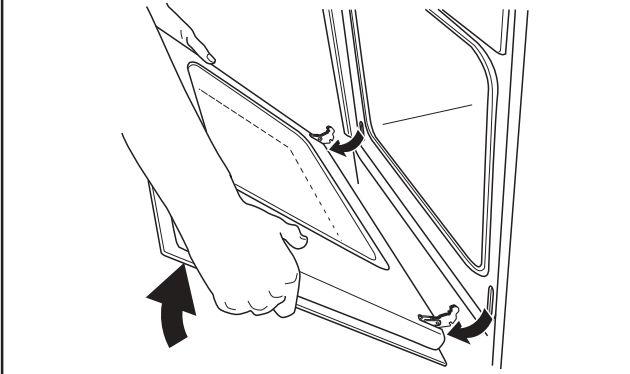

4. place the oven door on a solid surface, being careful to avoid the glass becoming scratched. Then remove the two screws located on the sides of the oven door;

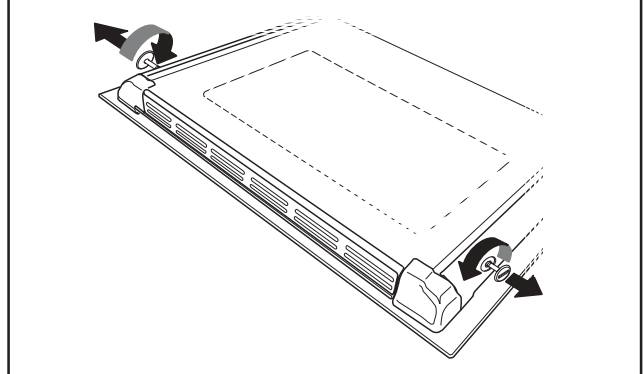

5. extract the inner glass support;

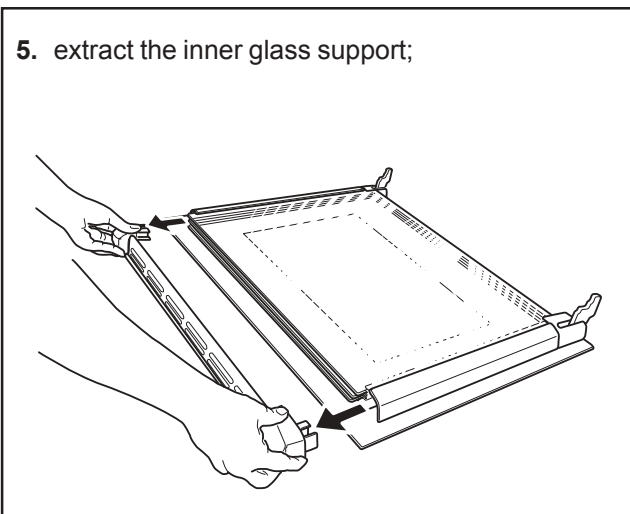

6. gently extract the two inner glasses, starting with the uppermost one first.

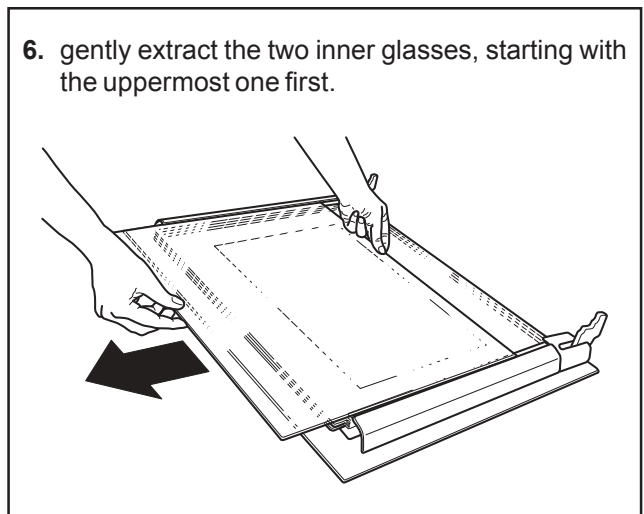

Clean the oven door glass with warm water and a soft cloth only. Never use harsh abrasives as they could damage the special heat-resistant surface of the inner glasses. Once the cleaning is carried out, refit the oven door, following the procedure in reverse.

**The two glasses in the middle are special glasses that have been treated to resist heat. They are marked with a small dot located on a corner and a black frame respectively.**

**It is important that, when refitting the oven door, the inner glasses are fixed in the right position.**

**To check if this operation has been carried out correctly, when inserting the glass, make sure that the surface of the glass marked with a black frame looks upwards and that the dot is located on the upper right corner of the glass (see diagram).**

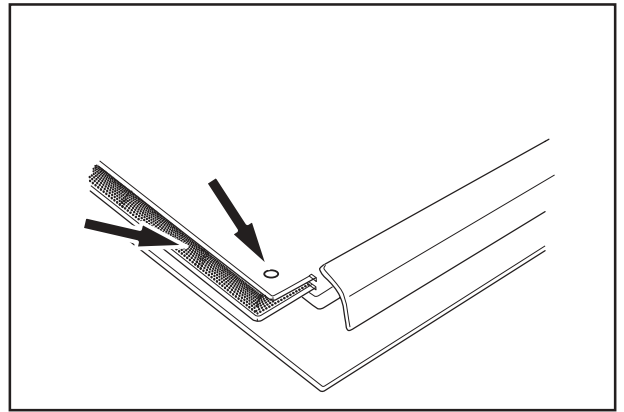

DO NOT clean the oven door while the glass panels are warm. If this precaution is not observed the glass panels may shatter. If the door glass panels become chipped or have deep scratches, the glasses will be weakened and must be replaced to prevent the possibility of the panel shattering. Contact your local Customer Care Department who will be pleased to advise further.

#### **Models in stainless steel or aluminium**

We recommend to clean the oven door using only a wet sponge and dry it after cleaning with a soft cloth.

Never use steel wool, acids or abrasive products as they can damage the oven surface. Clean the oven control panel following the same precautions.

## **Oven Shelves and Shelf Supports**

To clean the oven shelves, soak in warm soapy water and remove stubborn marks with a well wetted soap impregnated pad. Rinse well and dry with a soft cloth. The shelf supports can be removed for easy cleaning.

Proceed as follows:

- 1) remove the front screw while keeping the shelf support in position with the other hand (see diagram 1);
- 2) disengage the rear hook and take off the shelf support (see diagram 2);
- 3) once the cleaning is carried out, refit the shelf supports following the procedure in reverse.

Please, ensure the retaining nuts are secure when refitting the shelf support.

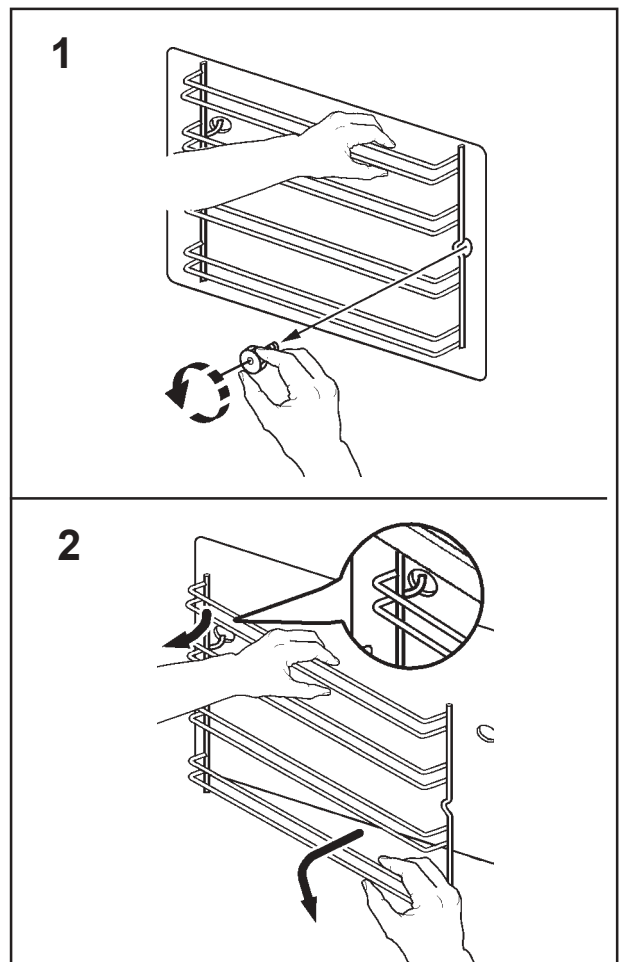



## The Hinged Grill

Some models are fitted with a hinged grill element, to enable you to clean the roof of the oven easily.

 **Before proceeding ensure the oven is cool and is isolated from the electricity supply.**

- Undo the screws which hold the grill in place (see diagram). When doing this operation for the first time, we recommend using a screwdriver.
- Then gently pull the grill downward to allow access to the oven roof.
- Clean the oven roof with a suitable cleaner and wipe dry before replacing the hinged grill element.
- Gently push up the grill element into place and firmly screw into place the holding nuts.

 **Ensure the grill holding nuts are firmly in place to avoid the grill falling down when in use.**

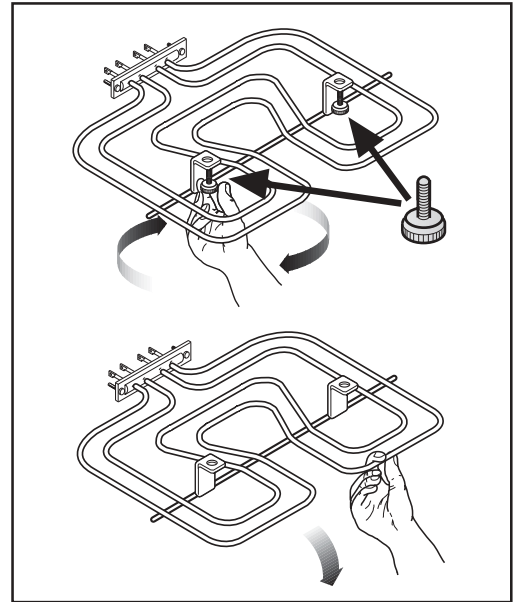

## Replacing the Oven Light

 **Disconnect the appliance from the power supply.**

If the oven bulb needs replacing, it must comply with the following specifications:

- Wattage power: 27 W,
- Voltage: 240 V (50 Hz),
- Resistant to temperatures of 300°C,
- Connection type: E14.

These bulbs are available from your local Service Force Centre.

 To replace the faulty bulb:

1. **Ensure the oven is disconnected from the electrical supply.**
2. Turn the glass cover anticlockwise.
3. Remove the faulty bulb and replace with the new one.
4. Refit the glass cover.
5. Reconnect to the electrical supply.

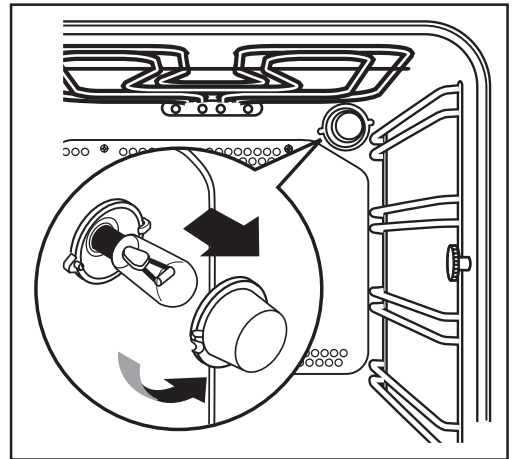

## Grease Filter

When cooking meat, the grease filter must be fitted over the oven fan by clipping it over the vents in the back panel. This will prevent a built-up of fat on the fan impellor. Do not use abrasive materials to clean the seal. The grease filter is dishwasher proof.

When cooking is completed and the oven has cooled down, remove the filter by pushing the protruding tongue on the filter upward (see diagram).

Wash the filter after use using warm soapy water.

**Fit the grease filter only when roasting.**

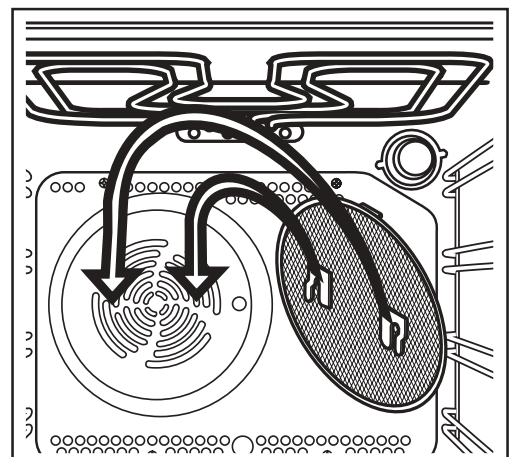

# Something not working

If the oven is not working correctly, please carry out the following checks, before contacting your local Service Centre. **IMPORTANT:** If you call out an engineer to a fault listed below, or to repair a fault caused by incorrect use or installation, a charge will be made even if the appliance is under guarantee.

<b>SYMPTOM</b>	<b>SOLUTION</b>
<ul style="list-style-type: none"> <li>■ The oven does not come on.</li> </ul>	<ul style="list-style-type: none"> <li>◆ Press the OVEN ON button, then select a cooking function.</li> <li>◆ Check the fuse and ensure the socket switch or the switch from the mains supply to the oven are ON.</li> </ul>
<ul style="list-style-type: none"> <li>■ The oven light does not come on.</li> </ul>	<ul style="list-style-type: none"> <li>◆ Switch on the oven using push button 1.</li> <li>◆ Check the light bulb, and replace it if necessary (see "Replacing the Oven Light")</li> </ul>
<ul style="list-style-type: none"> <li>■ It takes too long to finish the dishes, or they are cooked too fast.</li> </ul>	<ul style="list-style-type: none"> <li>◆ The temperature may need adjusting</li> <li>◆ Refer to the cooking function sections and to any cooking chart provided</li> </ul>
<ul style="list-style-type: none"> <li>■ Steam and condensation settle on the food and the oven cavity.</li> </ul>	<ul style="list-style-type: none"> <li>◆ Leave dishes inside the oven no longer than 15-20 minutes after the cooking is completed.</li> </ul>
<ul style="list-style-type: none"> <li>■ The electronic programmer does not work.</li> </ul>	<ul style="list-style-type: none"> <li>◆ Check the instructions for the electronic programmer.</li> </ul>
<ul style="list-style-type: none"> <li>■ The oven fan is noisy.</li> </ul>	<ul style="list-style-type: none"> <li>◆ Check that shelves and bakeware are not vibrating in contact with the oven back panel.</li> </ul>
<ul style="list-style-type: none"> <li>■ Error code, for example "POBERR 80", appears on the control panel.</li> </ul>	<ul style="list-style-type: none"> <li>◆ Take note of the error code and contact an authorised Service Centre.</li> </ul>
<ul style="list-style-type: none"> <li>■ The display shows "12.00".</li> </ul>	<ul style="list-style-type: none"> <li>◆ Set the time of day (see chapter "To set the Correct Time of Day").</li> </ul>

# Installation



*The oven must be installed according to the instructions supplied.*

## Technical Data

### Dimensions of recess

Height	undertop: 593 mm; in column 580 mm
Width	560 mm
Depth	550 mm

### Dimensions of the oven cavity

Height	335 mm
Width	395 mm
Depth	400 mm
Oven capacity	53 litres



*This oven must be installed according to standards and regulation currently in force.*

## Heating elements rating

Conventional cooking	1,96 W
Top element	870 W
Bottom element	1,09 W
Convection element	2,18 W
Grill element	1,80 W
Double Grill element	2,67 W
Thermal Grilling	2,70 W
Pizza Function	2,26 W
Oven Light	27 W
Cooling Fan	27 W
Convection Fan	27 W
Total Rating	2,72 W
Supply voltage (50 Hz)	240 V

# Electrical Connection

The oven is designed to be connected to 240 V (50 Hz) electricity supply.

The oven has an easily accessible terminal block which is marked as follows.

Letter L      Live terminal

Letter N      Neutral terminal



Earth

The cable used (of the types: H07 RN-F, H05 RN-F, H05 RR-F, H05 VV-F, H05 V2V2-F (T90), H05 BB-F) must have a min. cross section of 1.5 mm<sup>2</sup>.

In order to connect it to the oven it is necessary to remove the hatch at the back of the oven to reach the terminal block.

For direct connection to the mains supply a two pole switch with a minimum rating of 13 A and a minimum distance of 3 mm between its contacts must be fitted between the supply and appliance.

This switch must not break the yellow/green earth cable at any point.



**The appliance must be earthed**

## Important

After installation and connecting, the cable must be placed so that it cannot at any point reach a temperature more than 50°C above the ambient temperature. Before the appliance is connected check that:

- the main fuse and the domestic installation can support the load;
- the power supply is properly earthed;
- the double pole switch used to connect the appliance to the supply is easily accessible after installation.

# Building In

Please ensure that when the oven is installed it is easily accessible for the engineer in the event of a breakdown.

## Building In

The surround or cabinet into which the oven will be built must comply with these specifications:

- the dimensions must be as shown in the relevant diagrams;
- the materials must withstand a temperature increase of at least 60 °C above ambient;
- proper arrangements must be made of a continuous supply of air to the oven to prevent the oven overheating.

Dimensions of the oven and recess required are given in the relevant diagrams.

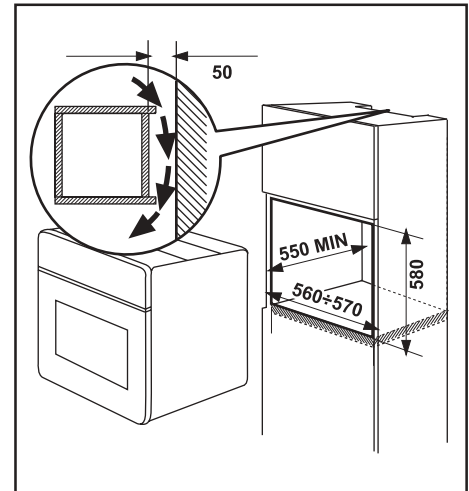
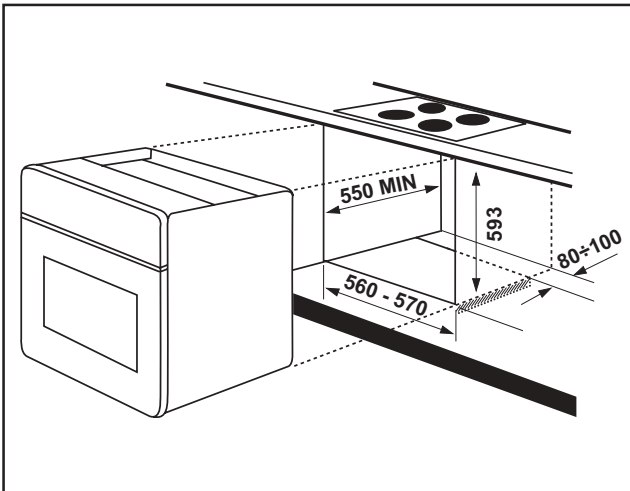
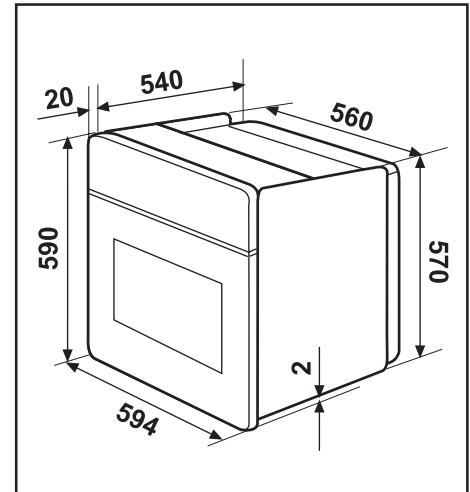

## Securing The Oven To The Cabinet

1. Fit the oven into the cabinet recess,
2. Open the oven door,
3. Secure the oven to the kitchen cabinet with four wood screws, which fit the holes provided in the oven frame.

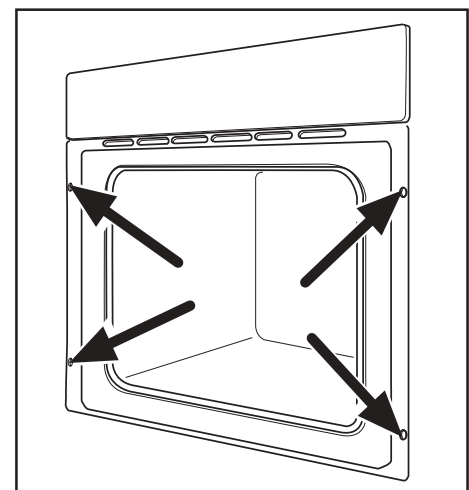

# Electrolux Warranty

FOR SALES IN AUSTRALIA AND NEW ZEALAND  
APPLIANCE: [ELECTRIC OVEN]

**This document sets out the terms and conditions of product warranties for Electrolux branded appliances. It is an important document. Please keep it with your proof of purchase documents in a safe place for future reference should you require service for your Electrolux appliance.**

## General Terms and Conditions

### 1. In this warranty

(a) 'Electrolux' means Electrolux Home Products Pty Ltd ABN 51 004 762 341 in respect of Appliances purchased in Australia and Electrolux (NZ) Limited in respect of Appliances purchased in New Zealand;

(b) 'Appliance' means any Electrolux product purchased by you accompanied by this document;

(c) 'Warranty Period' means

(i) where you use the Appliance for personal, domestic or household purposes in Australia the period of 24 months and in New Zealand the period of 24 months;

(ii) where you use the Appliance for commercial purposes, in Australia the period of 3 months and in New Zealand the period of 3 months, (if the period stated is 0 months you are not covered by this product warranty)

following the date of original purchase of the Appliance;

(d) 'you' means the purchaser of the Appliance not having purchased the appliance for re-sale, and 'your' has a corresponding meaning.

2. This warranty only applies to Appliances purchased and used in Australia or New Zealand and is in addition to (and does not exclude, restrict, or modify in any way) any non-excludable statutory warranties in Australia or New Zealand.

3. Electrolux warrants that, when dispatched from an Electrolux warehouse, the Appliance is free from defects in materials and workmanship for the Warranty Period.

4. During the Warranty Period Electrolux or its Authorised Service Centre will, at no extra charge if your appliance is readily accessible without special equipment, and subject to these terms and conditions, repair or replace any parts which it considers to be defective. You agree that any replaced Appliances or parts become the property of Electrolux. This warranty does not apply to light globes, batteries, filters or similar perishable parts.

5. Parts and Appliances not supplied by Electrolux are not covered by this warranty.

6. Where you are within an Electrolux service area, this warranty covers the cost of transport of the Appliance to and from Authorised Service Centres of Electrolux and travelling costs for representatives of the Authorised Service Centre to and from your home or business. If you are outside an Electrolux service area, you will bear these costs. For information about whether you are within an Electrolux service area, please phone 13 13 49 in Australia, or 0800 10 66 10 in New Zealand.

7. Proof of purchase is required before you can make a claim under this warranty.

8. You may not make a claim under this warranty unless the defect claimed is due to faulty or defective parts or workmanship. Electrolux is not liable in the following situations (which are not exhaustive):

(a) The Appliance is damaged by:

(i) accident

(ii) misuse or abuse, including failure to properly maintain or service

(iii) normal wear and tear

(iv) power surges, electrical storm damage or incorrect power supply

(v) incomplete or improper installation

(vi) incorrect, improper or inappropriate operation

(vii) insect or vermin infestation.

(b) The Appliance is modified without authority from Electrolux in writing.

(c) The Appliance's serial number or warranty seal has been removed or defaced.

(d) The Appliance was serviced or repaired by anyone other than Electrolux or its Authorised Service Centres.

9. This warranty, the contract to which it relates and the relationship between you and Electrolux are governed by the law applicable in the Australian State where the Appliance was purchased or the law applicable in New Zealand if the Appliance was purchased in New Zealand. Where the Appliance was purchased in New Zealand for business purposes the Consumer Guarantee Act does not apply.

**Limitation of Liability**

10. To the extent permitted by law:

- (a) Electrolux excludes all warranties other than as contained in this document;
- (b) Electrolux shall not be liable for any loss or damage whether direct or indirect or consequential arising from your purchase, use or non-use of the Appliance.

11. Provisions of the Trade Practices Act and State consumer legislation in Australia, and the Consumer Guarantees Act, the Sale of Goods Act and the Fair Trading Act in New Zealand, imply warranties or conditions, or impose obligations, upon Electrolux which cannot be excluded, restricted or modified. To the extent permitted by law, the liability of Electrolux (if any) arising out of or in relation to the Appliance or any services supplied by Electrolux shall be limited (where it is fair and reasonable to do so),:

- (a) in the case of Appliances, at its option, to the replacement or repair of the Appliances or the supply of equivalent products or the payment of the cost of replacing the Appliances or having the Appliances repaired or of acquiring equivalent Appliances. Upon being replaced, parts and Appliances become the property of Electrolux; or
- (b) in the case of services, at its option, to the supply of the services again or the payment of the cost of having the services re-supplied;



and in the case of Appliances or services supplied in New Zealand, loss or damage whether direct or indirect or consequential that is reasonably foreseeable.

**Privacy**

You acknowledge that in the event that you make a warranty claim it will be necessary for Electrolux and its Authorised Service Centres to exchange information in relation to you to enable Electrolux to meet its obligations under this warranty.

**Important Notice**

Before calling a Service Technician please check carefully the operating instructions, service booklet and the warranty terms and conditions.

<p><b>FOR SERVICE</b> OR TO FIND THE ADDRESS OF YOUR NEAREST STATE SERVICE CENTRE IN AUSTRALIA <b>Please call 13 13 49</b> For the cost of a local call (Australia only)</p>	<p><b>SERVICE AUSTRALIA</b></p> <p></p> <p><b>ELECTROLUX HOME PRODUCTS</b></p>	<p><b>FOR SPARE PARTS</b> OR TO FIND THE ADDRESS OF YOUR NEAREST STATE SPARE PARTS CENTRE IN AUSTRALIA <b>Please call 13 13 50</b> For the cost of a local call (Australia only)</p>
<p><b>FOR SERVICE</b> OR TO FIND THE ADDRESS OF YOUR NEAREST AUTHORISED SERVICE CENTRE IN NEW ZEALAND <b>Free call 0800 10 66 10</b> (New Zealand only)</p>	<p><b>NEW ZEALAND SPARE PARTS CENTRES</b></p> <p><b>AUCKLAND</b> Prime Distributors Ltd. 8 Highbrook Drive, East Tamaki..... (09) 273 3580  <b>WELLINGTON</b> Prime Distributors Ltd. 68 Victoria Street, Petone..... (04) 586 2150  <b>CHRISTCHURCH</b> Prime Distributors Ltd. Unit 1, 127 Montreal Street.... (03) 377 1009  R. Redpath Ltd. 55 Ferry Road..... (03) 379 0446  <b>DUNEDIN</b> South City Champion, 590 Hillside Road..... (03) 455 5443</p> <p> <b>ELECTROLUX HOME PRODUCTS</b></p>	

-	ES	DA	DE	EL	EN	FR	IT	NL	PT	SV	FI	
1	Fabricante	Mærke	Hersteller	Προμηθευτής	Manufacturer	Fabricant	Costruttore	Fabrikant	Fabricante	Leverantör	Tavarantoimittaja	<b>Electrolux</b>
2	Modelo	Model	Modell	Μοντέλο	Model	Modèle	Modello	Model	Modelo	Modell	Malli	<b>EOB 6790</b>
3	Clase de eficiencia energética	Relativt energiforbrug	Energieeffizienzklasse	Τάξη ενεργειακής απόδοσης	Energy efficiency class	Classement selon son efficacité énergétique	Classe di efficienza energetica	Energie-efficiëntieklasse	Classe de eficiência energética	Energieeffektivitetsklass	Energiatohokkuusluokka	<b>A</b>
4	- Calentamiento convencional	- Traditionel opvarmning	- Konventionelle Beheizung	- Συμβατική	- Conventional	- Classique	- Convezione naturale	- Conventioneel	- Conveccção	- Konventionell värmning	- Ylä-alalämpö	
5	- Convección forzada	- Varmluft	- Um/Heißluft	- Με κυκλοφορία θερμού αέρα	- Forced air convection	- Convection forcée	- Convezione forzata	- Geforceerde luchtconvector	- Convecção forçada de ar	- Värmning med varmluft	- Kiertolima	<b>←</b>
	Consumo de energía Función de calentamiento:	Energiforbrug Opvarmningsfunktion:	Energieverbrauch Beheizung:	Κατανάλωση ενέργειας Αετοσυργία θέρμανσης	Energy consumption Heating function:	Consommation d'énergie Fonction chauffage:	Consumo di energia Funzione di riscaldamento:	Energieverbruik Verhittingsfunctie:	Consumo de energia Função de aquecimento:	Energiförbrukning Värmningsfunktion:	Energiankulutus Kuunnennustapa:	
6	- Calentamiento convencional	- Traditionel opvarmning	- Konventionelle Beheizung	- Συμβατική	- Conventional	- Classique	- Convezione naturale	- Conventioneel	- Conveccção	- Konventionell värmning	- Ylä-alalämpö	0,79 kWh
7	- Convección forzada	- Varmluft	- Um/Heißluft	- Με κυκλοφορία θερμού αέρα	- Forced air convection	- Convection forcée	- Convezione forzata	- Geforceerde luchtconvector	- Convecção forçada de ar	- Värmning med varmluft	- Kiertolima	0,78 kWh
8	- Vapor	- Damp	- Dampf	- Ατμός	- Steam	- Vapeur	- Vapore	- Stoom	- Vapor	- Ånga	- Höyry	
9	Volumen neto (litros)	Nettovolumen (liter)	Nettovolumen (Liter)	Ωφέλιμος όγκος (λίτρα)	Usable volume (litres)	Volume utile (litres)	Volume utile (litri)	Netto volume (liter)	Volume útil Litros	Användbar volym (liter)	Käyttötilavuus (litraa)	53,0
	Tipo: ●●●●● ●●●● ●●● ●● ●	Type: - Lille - Mellemstort - Stort	Type: - Klein - Mittel - Groß	Τύπος: - Μικρός - Μεσαίος - Μεγάλος	Size: - Small - Medium - Large	Type: - Faible volume - Volume moyen - Grand volume	Tipo: - Piccolo - Medio - Grande	Type: - Klein - Middel/groot - Groot	Tipo: - pequeno - médio - grande	Storlek: - Liten - Medelstor - Stor	Koko: - Pieni - Keskipikoinen - Suuri	<b>←</b>
	Tiempo de cocción con carga normal:	Tilberedningstid ved standardbelastning:	Kochzeit bei Standardbelastung:	Χρόνος για ψησιμο τυποποιημένου φορτίου:	Time to cook standard load:	Temps de cuisson en charge normale:	Tempo necessario per cottura carico normale:	Bereidings-tijd bij standaardbelasting:	Tempo de cozedura da carga-padrão:	Tillagningstid för en standardlast:	Paistoaika vakiokuomalla:	
10	- Calentamiento convencional	- Traditionel opvarmning	- Konventionelle Beheizung	- Συμβατική	- Conventional	- Classique	- Convezione naturale	- Conventioneel	- Conveccção	- Konventionell värmning	- Ylä-alalämpö	43 min.
11	- Convección forzada	- Varmluft	- Um/Heißluft	- Με κυκλοφορία θερμού αέρα	- Forced air convection	- Convection forcée	- Convezione forzata	- Geforceerde luchtconvector	- Convecção forçada de ar	- Värmning med varmluft	- Kiertolima	41 min.
12	Superficie de la placa de cocción de mayor tamaño	Arealet af den største bageplade	Größe des größten Backblechs	Η μεγαλύτερη επιφάνεια ψησίματος εκπορεύμενη	The area of the largest baking sheet	Airs de la surface de la plus grande plaque pour pâtisserie	Superficie del piano di cottura più grande	Oppervlakte van de grootste bakplaat	Área da superfície da maior placa de pastelaria	Ytan för den största bakplåten	Suurimman leivinpellin ala	1130 cm <sup>2</sup>
13	Ruido [dB (A) re 1 pW]	Lydeffektniveau dB (A) (Støj)	Geräusch (dB (A) re 1 pW)	Ξόρυθος [dB (A) ανά 1 pW]	Noise (dB (A) re 1 pW)	Bruit [dB (A) re 1 pW]	Rumore [dB (A) re 1 pW]	Geluidsniveau dB (A) re 1 pW	Nível de ruído dB (A) re 1 pW	Bullemnivå dB (A)	Ääni (dB (A) re 1 pW)	
	● Más eficiente Løvt forbrug Niedriger Verbrauch Παροικονομία More efficient Econome	Bassi consumi Efficient Mais efficace Låg förbrukning Vahan kuluttava			Menos eficiente Højt forbrug Hoher Verbrauch Αποικονομία Less efficient Peu econome	Alti consumi Inefficient Menos eficiente Hög förbrukning Pajjon kuluttava		●● 12 l ≤Volumen neto/Nettovolumen/Ωφέλιμος όγκος/Usable volume/Volume utile/ Netto volume/Volume útil/Användbar volym/Käyttötilavuus < 35 l ●●● 35 l ≤Volumen neto/Nettovolumen/Ωφέλιμος όγκος/Usable volume/Volume utile/ Netto volume/Volume útil/Användbar volym/Käyttötilavuus < 65 l ●●●● 65 l ≤Volumen neto/Nettovolumen/Ωφέλιμος όγκος/Usable volume/Volume utile/ Netto volume/Volume útil/Användbar volym/Käyttötilavuus				2002/40/EC

 **From the Electrolux Group. The world's No.1 choice.**

The Electrolux Group is the world's largest producer of powered appliances for kitchen, cleaning and outdoor use. More than 55 million Electrolux Group products (such as refrigerators, cookers, washing machines, vacuum cleaners, chain saws and lawn mowers) are sold each year to a value of approx. USD 14 billion in more than 150 countries around the world.